

# Handheld Digital Storage Oscilloscopes 2510B Series



### Features and benefits

- 100 MHz (2511B/2512B) and 200 MHz (2515B/2516B) bandwidth
- Maximum sample rate of 1 GSa/s
- Maximum memory depth of 12 Mpts
- Waveform update rate of 100,000 wfms/s (Normal mode), up to 400,000 wfms/s (Sequence mode)
- 2 fully isolated and floating 1,000 V CAT II, 600 V CAT III rated inputs (isolated models 2515B and 2516B)
- 300 V CAT II rated inputs (non-isolated models 2511B and 2512B)
- Built-in 6000 count DMM with True RMS AC voltage and current measurements
- Scope recorder and meter trend plots for data logging
- 5.6" TFT-LCD (640 x 480)
- Compact and lightweight – 3.86 lbs (1.75 kg)
- Up to 5 1/2 hours (2511B / 2512B) or 4 hours (2515B / 2516B) respectively, of continuous battery operation
- FFT including seven additional math functions: add, subtract, multiply, divide, differentiate, integrate, and square root
- 38 automatic measurements
- Serial bus decoding for IIC, SPI, UART, CAN and LIN protocols
- USB host port for saving and recalling waveform setups, data, and screenshots on a USB flash drive
- USB device port (Micro USB-TMC) for PC connectivity
- Supports SCPI commands

The 2510B Series handheld digital storage oscilloscopes combine floating measurement and recorder capabilities with a built-in digital multimeter (DMM), all in one portable and lightweight package.

These versatile scopes provide two analog channels with a maximum bandwidth of 200 MHz and a maximum sample rate of 1 GSa/s. Additionally, the 12 Mpts memory depth, sequence mode, and 400,000 waveforms per second update rate, allow users to capture transients and long-term signal behavior with excellent signal fidelity.

Models 2515B and 2516B offer full isolation between both the oscilloscope channels, the multimeter channel, the power input and the USB host and device port.

The built-in 6000-count multimeter allows users to quickly transition from an oscilloscope to a DMM to measure DC/AC voltage and current, resistance, and capacitance, including diode and continuity tests.

These handheld DSOs feature many useful recording functions such as scope recorder and trend plot, which allows data logging from the oscilloscope and multimeter inputs. The scope recorder function provides sample rates up to 25 kSa/s, 50 MB internal memory, and support to write directly to an external drive for up to 2 GB. The trend plot allows users to log oscilloscope or meter measurements at a slower rate up to 10 Hz with a maximum memory depth of 3.6 M samples.

The 2510B Series handheld oscilloscopes are ideal for industrial applications, power systems, electronic design, and field test and service.

Model	2511B	2512B	2515B	2516B
Bandwidth	100 MHz	200 MHz	100 MHz	200 MHz
Channels	2 non-isolated		2 fully isolated	
Typical applications	General electronics		Power electronics and industrial	

## The tools you need

### 12 Mpts Memory Depth

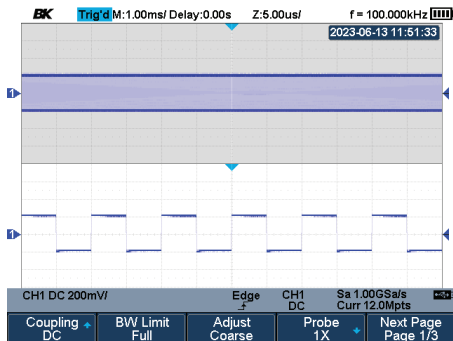

See more details in your waveform with deep memory. Capture waveforms in high resolution while maintaining a high sample rate over a wider period of time than other comparable scopes.

### Powerful Measurement Functions

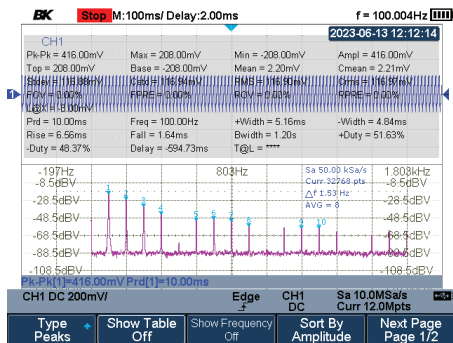

Display and measure the input signal's frequency spectrum. Select one of the 5 FFT windows: Rectangular, Hanning, Hamming, Blackman, and Flatop. Use cursors to measure the spectral component's magnitude and frequency.

### Portable Operation



Built for portability, the 2510B Series handheld digital oscilloscopes are rugged, compact, lightweight and battery powered. All models come standard with travel case for safe transport.

### Built-in Digital Multimeter

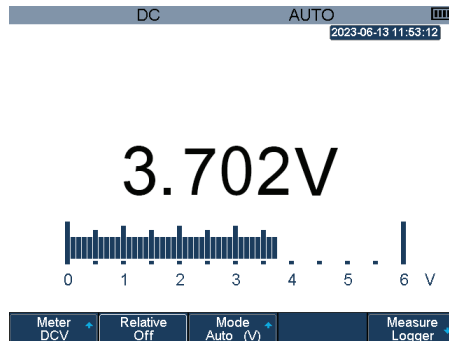

Speed up troubleshooting with the built-in 6000-count multimeter. Measurement functions include AC/DC voltage and current, resistance, capacitance, diode, and continuity test.

### Serial Bus Decoding



Decoding mode displays the serial bus data through the events list. Bus protocol information can be quickly and intuitively displayed in a tabular format.

### PC Software



PC software provided for seamless integration between the oscilloscope and PC. Capture and transfer waveforms, screen images, setups and measurement results to a PC via the USB device port.

### Scope and Meter Trend Plot Functions

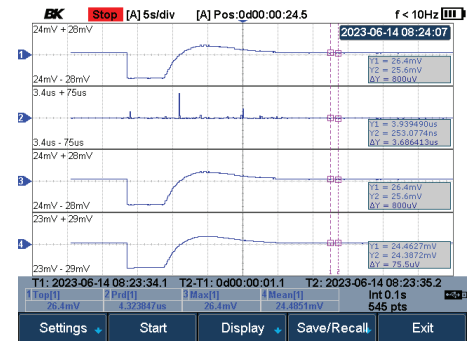

Scope Trend Plot

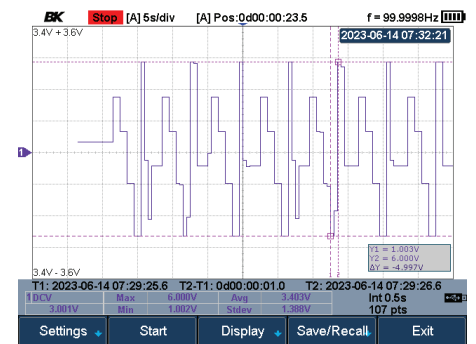

Meter Trend Plot

The trend plot function can be used with the oscilloscope or built-in DMM to plot measurement values over time. Up to four voltage or time parameters can be selected by the scope, and any one of the multimeter's measurement functions can be graphed. These data can then be exported as a binary, CSV, or Matlab file for further analysis.

### Waveform Recording

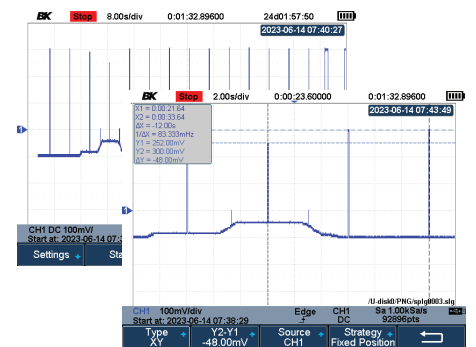

Use sample logging to monitor and analyze long-term signal behavior by recording data continuously at up to 25 kSa/s. This mode allows recorded data to be played back for post acquisition analysis.

### Floating and Differential Measurements

Many industrial applications such as power electronics require measurements of high voltages and currents that are not referenced to ground. Traditional line-powered oscilloscopes typically have signal common connected to earth ground, which is usually the chassis of the oscilloscope. This means that all measurements must be made relative to earth ground, which prevents users from making differential measurements where none of the test points are referenced to ground.

As a workaround, some people choose to "float" an oscilloscope by removing the connection between the instrument's chassis (including the outside of BNC jacks) and the power line ground. Floating a scope is not recommended as it can put the user at a safety risk as well as yield poor measurement results due to parasitic capacitance, which can cause ringing and invalidates the measurement. The 2510B Series allow engineers and technicians to make accurate and safe measurements when the signal reference is floating and neither of the two test points is referenced to earth ground.

### Fully Isolated Channel Design for Safe Measurements (models 2515B/2516B only)

Models 2515B and 2516B offer floating measurement capability with two CAT III 600 V input channels and feature an electrically isolated circuit design between inputs and the digital acquisition circuit. Isolating the ground references eliminate ground loops and help reduce channel noise and crosstalk.

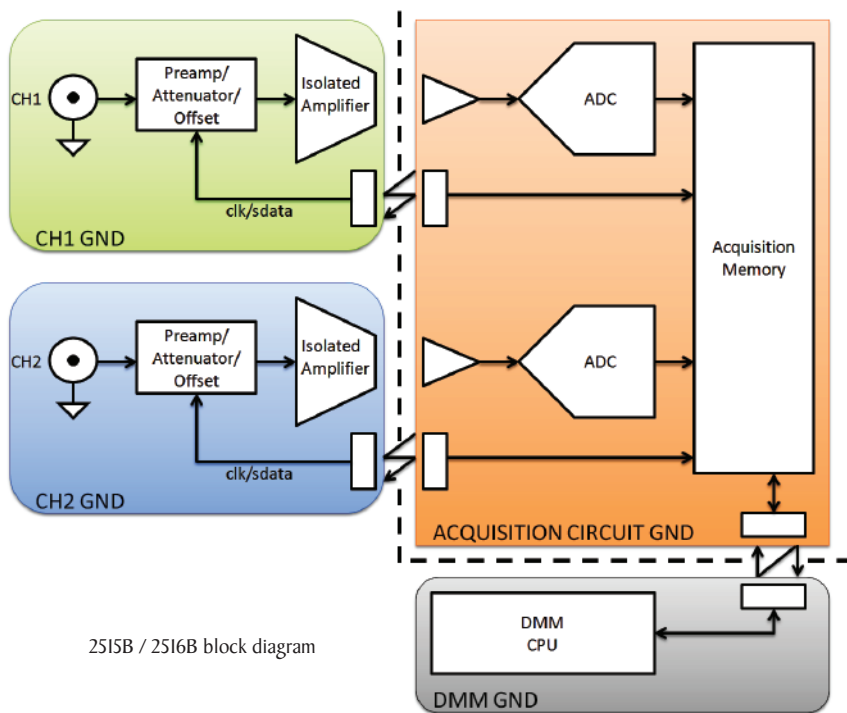

### Safety Rated High Bandwidth Oscilloscope Probes



Probe Model PR250SA



Probe Model PR250B

All 2510B Series models come standard with high bandwidth, safety certified passive probes (one per channel) to help you get the most out of your scope.

Model	Included Probes
2511B 2512B	Two 250 MHz bandwidth, x1/x10 probes rated for 300 V CAT II
2515B 2516B	Two touch-protected 250 MHz bandwidth, x10 probes rated for 1000 V CAT II, 600 V CAT III measurements

Model	Maximum Signal Input Safety Rating		Maximum Reference Floating Safety Rating
	with probe	without probe	
2511B / 2512B	300 Vrms CAT II	300 Vrms CAT II	30 Vrms
2515B / 2516B	1000 Vrms CAT II, 600 Vrms CAT III	300 Vrms CAT II	1000 Vrms CAT II, 600 Vrms CAT III

## Front and Side Panel

Top view



Scope input terminals



5.6-inch TFT LCD color display

**Durable rubber bezel**  
Provides grip and protection against accidental bumps.

Scope and meter mode buttons

**Recorder function button**  
Use the scope recorder or trend plot functions to log oscilloscope or multimeter measurements.

CH1, CH2 vertical controls

**Horizontal control**

**Auto setup**  
Vertical, horizontal, and trigger controls are automatically adjusted for fast signal display.

**Multimeter shunts**  
10 A and 600 mA shunts are provided standard for current measurements.



**Multimeter input terminals**  
Dedicated terminals provided for voltage, resistance, and capacitance measurements.

**Micro USB device port**  
Connect to a PC for remote control through provided software.

Left side view



**Power input**  
Charge your device with the provided power adapter.

Right side view



**USB host port**  
Connect your USB flash drive to conveniently store and recall waveform data, setups, and screenshots.

**Carrying strap**  
The soft-felt strap can be attached to either side based on user preference.



## Specifications

Note: All specifications apply to the unit after a temperature stabilization time of 30 minutes over an ambient temperature range of 23 °C ± 5 °C.

Model	2511B	2512B	2515B	2516B
<b>Performance Characteristics</b>				
Bandwidth (-3B)	100 MHz	200 MHz	100 MHz	200 MHz
Real Time Sampling Rate	1 GSa/s (half-channel interleaved) <sup>(1)</sup> , 500 MSa/s (per channel)			
Channels	2 non-isolated		2 isolated	
Rise Time (typical)	< 3.5 ns	< 1.7 ns	< 3.5 ns	< 2.0 ns
Memory Depth	12 Mpts (half-channel interleaved), 6 Mpts (per channel)			
Waveform Update Rate	Up to 100,000 wfms/s (normal mode), 400,000 wfms/s (sequence mode)			
Ch to Ch Isolation	DC to Max BW: > 40 dB			
Probe Attenuation Selectable Factors	0.1X, 0.2X, 0.5X, 1X, 2X, 5X, 10X, 50X, 100X, 500X, 1000X, 2000X, 5000X, 10000X, Custom			
Input Coupling	AC, DC, GND			
Input Impedance	DC: (1 MΩ ± 2 %)    (14 pF ± 2 pF)		DC: (1 MΩ ± 2 %)    (14 pF ± 2 pF)	
DC Gain Accuracy	≤ ± 3 %: ≥ 10 mV/div ≤ ± 4 %: < 10 mV/div			
Max. Input Voltage	CAT II 300 Vrms Between BNC Signal and Protective Earth CAT II 30 Vrms Between BNC GND and Protective Earth CAT II 300 Vrms Between BNC Signal and BNC GND		CAT III 600 Vrms, CAT II 1000 Vrms Between BNC Signal and Protective Earth CAT III 600 Vrms, CAT II 1000 Vrms Between BNC GND and Protective Earth CAT III 300 Vrms Between BNC Signal and BNC GND	
<b>Vertical System</b>				
Vertical Resolution	8 bits		8 bits	
Sensitivity Range	2 mV/div to 100 V/div (1-2-5 order)		5 mV/div to 100 V/div (1-2-5 order)	
Voltage Offset Range (Probe 1x)	2 mV to 296 mV : ± 5 V 302 mV to 7.5 V : ± 80 V 7.6 V to 100 V : ± 400 V			
Offset Accuracy	± (1.5% of Offset + 1.5% per division + 5 mV)		± (1.5% of Offset + 1.5% per division + 5 mV)	
Bandwidth Limit	20 MHz ± 40%			
Bandwidth Flatness	DC to 10% (BW): ± 1 dB 10% to 50% (BW): ± 2 dB 50% to 100% (BW): +2 dB / -3 dB			
Low-Frequency Response (AC coupling -3 dB)	≤ 2 Hz (at input BNC)			
Noise/SNR	2 mV/div: > 24 dB 5 mV/div: > 25 dB ≥ 10 mV/div: > 35 dB P-P Noise ≤ 15 SDEV Spec			
SFDR Including Harmonics	≥ 30 dB		≥ 28 dB	
CMRR	-		> 100 dB DC > 50 dB to AC 1 MHz	
Overshoot (500 ps Pulse)	Typical 12%		Typical 18%	
<b>Horizontal System</b>				
Horizontal Scan Range	1.0 ns/div to 100 s/div			
Channel Skew	< 300 ps			
Timebase Accuracy	± 25 ppm			
Display Format	Y -T, X -Y, Roll			
Roll Mode	50 ms/div to 100 s/div (1-2-5 order)			

(1) Half channel operation means that only Ch 1 or Ch 2 is active.

## Specifications (cont.)

Acquisition System	
Peak Detect	2 ns
Average	Selectable from: 4, 16, 32, 64, 128, 256, 512, 1024
Enhance Resolution (ERES)	Enhance bits: 0.5, 1.5, 2, 2.5, 3
Interpolation	Sin(x)/x, Linear
Trigger System	
Types	Edge, Slope, Pulse Width, Video, Window, Interval, Dropout, Runt, Pattern Serial Triggers: I2C, SPI, UART, CAN, LIN
Modes	Auto, Normal, Single
Level	Internal: $\pm 4.5$ div from the center of the screen
Holdoff Range	80 ns to 1.5 s
Coupling	AC, DC, LF reject, HF reject
Coupling Frequency Response	AC: Blocks DC components and attenuates signals below 8 Hz DC: Passes all components of the signal LFRJ: Blocks the DC component and attenuates low-frequency components below 2 MHz HFRJ: Attenuates high-frequency components above 1.2 MHz
Accuracy (typical)	Internal: $\pm 0.2$ div
Sensitivity	DC to Max BW: 0.8 div
Jitter	< 100 ps
Displacement	Pre-trigger: 0 to 100 % Memory Delay Trigger: 0 to 10,000 div
Source	All Channels
Waveform Measurements and Math	
Source	All channels, zoom, math, references, history
Number of Measurements	4 displayed simultaneously, 5 displayed in statistics table
Measurement Range	Screen or gate region
Measurement Parameters	38 Types
Vertical	Max, Min, Pk-Pk, Ampl, Top, Base, Mean, Cmean, Stdev, Cstd, VRMS, Crms, FOV, FPRE, ROV, RPRE, Level@X
Horizontal	Period, Freq, +Width, -Width, Rise time, Fall time, Bwid, +Duty, -Duty, Delay, Time@Level
Delay	Phase, FRFR, FRFF, FFFR, FFFF, FRLR, FRLF, FFLR, FFLF, Skew
Cursors	Manual: Time X1, X2, (X1 -X2), (1/ $\Delta$ T) Voltage Y1, Y2, (Y1 -Y2) Track: Time X1, X2, (X1 -X2)
Statistics	Current, Mean, Min, Max, Stdev, Count
Counter	Hardware 6-digit counter
Math Operation	+ , - , * , / , FFT , d/dt , fdt , $\sqrt{\quad}$
FFT Window	Rectangular, Blackman, Hanning, Hamming, Flattop
FFT Display	Full Screen, Split, Exclusive
Cursors	
Types	Voltage, Time
Measurements	$\Delta$ V, $\Delta$ T, 1/ $\Delta$ T (frequency)
Search	
Event	Edge, Slope, Pulse, Interval, Runt
Event Number	Y – T: 600 Roll: No limit Stop after roll: 600

## Specifications (cont.)

Model	2511B and 2512B	2515B and 2516B
<b>Display System</b>		
Display Type	5.6" TFT LCD	
Display Resolution	640 x 480 pixels	
Color	24-bit	
Contrast (typical)	500:1	
Backlight Intensity (typical)	200 nits	
Wave Display Range	8 x 12 divisions	
Wave Display Mode	Dots, Vector	
Color Mode	Normal, Color Grade	
Intensity Grading	256 levels	
Persistence	Off, 1 sec, 5 sec, 10 sec, 30 sec, Infinite	
Screen-Saver	Off, 1 min, 5 min, 10 min, 30 min, 1 hr	
Zoom	Vertically or horizontally expand or compress a live or stopped waveform	
Language	English, French, Japanese, Korean, German, Spanish, Russian, Italian, Portuguese, Simplified Chinese, Traditional Chinese	
<b>I/O Interface</b>		
USB Host	1 port, isolated type A plug, full/low speed, supports USB flash drives	
USB Device	1 port, micro USB-B, remote connectivity	
Probe Compensation	1 kHz, 0 to 5 V square wave output	
<b>Environmental</b>		
Temperature	Operating: 32 °F to 104 °F (0 °C to +40 °C) Non-operating: 68 °F to 140 °F (-20 °C to +60 °C)	
Humidity	Operating: 85% RH, 104 °F (40 °C), 24 hours Non-operating: 85% RH, 149 °F (65 °C), 24 hours	
Altitude	Operating: ≤ 6,561.68 ft (2000 m) Non-operating: ≤ 16,404.2 ft (5000 m)	
Electromagnetic Compatibility	Meets EMC directive (2014/30/EU), meets or exceeds IEC 61326-1:2012/EN61326-1:2013 (Basic)	
Safety	UL 61010-1:2012/R:2018-II; CAN/CSA-C22.2 No. 61010-1:2012/A1:2018-II. UL 61010-2-030:2018; CAN/CSAC22.2 No. 61010-2-030:2018., UL 61010-2-033:2020.	
<b>General</b>		
Power Adapter Input	100 to 240 VAC, 50/60 Hz, 1.2 A	100 to 240 VAC, 50/60 Hz, 1.1 A
Power Adapter Output	9 V, 4 A	12 V, 4 A
Operating Time (typical)	5.5 hours	4 hours
Battery Capacity	6900 mAh	
Charging Protection	≥ 55 °C at Battery	
Power Consumption	9 W	11 W
IP Rating	IP51	
Dimensions (W x H x D)	6.61" x 10.87" x 2.68" (168 x 276 x 68 mm)	
Weight (with battery)	Without package: 3.86 lbs (1.75 kg)	
Warranty	3 Years	
Standard Accessories	Power adapter, USB cable, passive probe (x2), 600 mA shunt, 10 A shunt, carrying bag, battery pack	

## Specifications (cont.)

Serial Decoder	
Decoders	2
Threshold	-4.5 to 4.5 divisions
List	1 to 7 lines
I2C	
Signal	SCL, SDA
Address	7, 10 bits
SPI	
Signal	SCL, MISO, MOSI, CS indentifiers
Edge Select	Rising, Falling
Idle Level	Low, High
Bit Order	MSB, LSB
UART	
Signal	Rx, Tx
Data Width	5, 6, 7, 8 bits
Parity Check	None, Odd, Even, Space, Mark
Stop Bit	1, 1.5, 2 bits
Idle Level	Low, High
CAN	
Signal	CAN_H, CAN_L
Source	CAN_H, CAN_L, CAN_H - CAN_L
LIN	
Specification Package Revision	Ver1.3, Ver2.0

Data Logging	
Scope Recorder (Sample Logger)	
Source	CH1, CH2, CH1 & CH2
Sample Rate	1 Sa/s to 25 kSa/s (1-2-5 order)
Memory Depth	50 MB internal, supports up to 2 GB external memory
Log Time (max. sampling)	Approx. 23 min in single-channel mode, 11 min in two channels mode with internal memory Approx. 22 hours in single-channel mode, 11 hours in two-channel mode with external memory
Data Format	Binary
Trend plot (Measurement Logger)	
Source	Oscilloscope or Meter input
Log Interval	0.1 s to 10 min
Simultaneous Logging	4 plots max
Memory Depth	Approximately 3.6 Msamples in single-channel mode, 900 ksamples in four-channel mode
Log Time(min. interval)	Approximately 100 hours
Data Format	Binary
Exportable Format	Binary, CSV, MATLAB

Multimeter (DMM)			
Max. Resolution	6000 counts		
Max. Input Voltage	2511B, 2512B: CAT III 300 Vrms, CAT II 600 Vrms 2515B, 2516B: CAT III 600 Vrms, CAT II 1000 Vrms		
Max. Voltage (shunt)	CAT III 60 Vrms		
Function	Range	Resolution	Accuracy <sup>(4)</sup>
DC Voltage	60.00 mV	10 µV	± (1% + 15 digits)
	600.0 mV	100 µV	
	6.000 V	1 mV	± (1% + 15 digits)
	60.00 V	10 mV	
	600.0 V	100 mV	± (1% + 15 digits)
1000 V <sup>(2)</sup>	1 V		
AC Voltage (45 Hz to 400 Hz)	60.00 mV	10 µV	± (1% + 15 digits)
	600.0 mV	100 µV	
	6.000 V	1 mV	± (1% + 15 digits)
	60.00 V	10 mV	
	600.0 V	100 mV	± (1% + 15 digits)
750 V <sup>(2)</sup>	1 V		
DC Current <sup>(3)</sup>	60.00 mA	10 µA	± (1% + 15 digits)
	600.0 mA	100 µA	
	6.000 A	1 mA	± (1% + 15 digits)
	10.00 A	10 mA	
AC Current <sup>(3)</sup> (45 Hz to 400 Hz)	60.00 mA	10 µA	± (1% + 15 digits)
	600.0 mA	100 µA	
	6.000 A	1 mA	± (1% + 15 digits)
	10.00 A	10 mA	
Resistance	600.0 Ω	0.1 Ω	± (1% + 15 digits)
	6.000 kΩ	1 Ω	
	60.00 kΩ	10 Ω	
	600.0 kΩ	100 Ω	
	6.000 MΩ	1 kΩ	
	60.00 MΩ	10 kΩ	
Capacitance	40.00 nF	10 pF	± (1% + 15 digits)
	400.0 nF	100 pF	
	4.000 µF	1 nF	± (1% + 15 digits)
	40.00 µF	10 nF	
	400.0 µF	100 nF	
Diode	0 to 2 V		
Continuity	< 50 Ω alarm		

(2) Applies to 2515B/2516B only

(3) For 10 A range, measurement time should not exceed 10 seconds. Interval time 15 minutes

(4) Accuracy is based on ± (% of reading + offset)



## Specifications (cont.)

Serial Decode Trigger	
<b>I<sup>2</sup>C Trigger</b>	
Condition	Start, Stop, Restart, No Ack, EEPROM, 7 bits Address & Data, 10 bits Address & Data, Data Length
Data Format	Hex
Limit Range	EEPROM: =, >, <
Data Length	EEPROM: 1 byte Addr & Data: 1 to 2 byte Data Length: 1 to 12 byte
R/W Bit	Addr & Data: Read, Write, Don't care
<b>SPI Trigger</b>	
Condition	Data
Data Format	Binary
Data Length	4 to 96 bits
Bit Value	0, 1, X
Bit Order	LSB, MSB
<b>UART Trigger</b>	
Condition	Start, Stop, Data, Parity Error
Data Format	Hex
Limit Range	=, >, <
Data Length	1 byte
Data Width	5, 6, 7, 8 bits
Parity Check	None, Odd, Even, Space, Mark
Stop bit	1, 1.5, 2 bits
Idle Level	High, Low
Baud Rate (Selectable)	600, 1200, 2400, 4800, 9600, 19200, 38400, 57600, 115200, Custom bit/s
Baud Rate (Custom)	300 to 5,000,000 bit/s
<b>CAN Trigger</b>	
Condition	Start, Remote, ID, ID + Data, Error
ID	STD (11 bits), EXT (29 bits)
Data Format	Hex
Data Length	1 to 2 byte
Baud Rate	5k, 10k, 20k, 50k, 100k, 125k, 250k, 500k, 800k, 1M, Custom bit/s
<b>LIN Trigger</b>	
Condition	Break, Frame ID, ID + Data, Error
ID	1 byte
Data Format	Hex
Data Length	1 to 2 byte
Baud Rate (Selectable)	600/1200/2400/4800/9600/19200/Custom bit/s
Baud Rate (Custom)	300 bit/s to 20 Mbit/s

Trigger Types	
<b>Edge Trigger</b>	
Slope	Rising, Falling, Alternating (Rising & Falling)
<b>Slope Trigger</b>	
Slope	Rising, Falling
Limit Range	<, >, <>, ><
Time Range	2 ns to 4.2 ns
Resolution	1 ns
<b>Pulse Width Trigger</b>	
Polarity	+width, -width
Limit Range	<, >, <>, ><
Time Range	2 ns to 4.2 ns
Resolution	1 ns
<b>Video Trigger</b>	
Signal Standard	NTSC, PAL, 720p/50, 720p/60, 1080p/50, 1080p/60, 1080i/50, 1080i/60, Custom
Sync	Any, Select
Condition	Line, Field
<b>Window Trigger</b>	
Type	Absolute, Relative
<b>Interval Trigger</b>	
Slope	Rising, Falling
Limit Range	<, >, <>, ><
Time Range	2 ns to 4.2 ns
Resolution	1 ns
<b>Dropout Trigger</b>	
Timeout Type	Edge, State
Slope	Rising, Falling
Time Range	2 ns to 4.2 ns
Resolution	1 ns
<b>Runt Trigger</b>	
Polarity	+width, -width
Limit Range	<, >, <>, ><
Time Range	2 ns to 4.2 ns
Resolution	1 ns
<b>Pattern Trigger</b>	
Setting	Invalid, Low, High
Logic	AND, OR, NAND, NOR
Limit Range	<, >, <>, ><
Time Range	2 ns to 4.2 ns
Resolution	1 ns