

# USER'S MANUAL

## BM037, BM035, BM033, BM031 Clamp-on Multimeter Series



## 1) SAFETY

The meter meets UL/IEC/EN61010-1 Ed. 3.0, CAN/CSA C22.2 No. 61010-1 Ed. 3.0, UL/IEC/EN61010-2-032 Ed. 3.0, UL/IEC/EN61010-2-033 Ed. 1.0 to Measurement CAT-III 600V and CAT-IV 300V, AC & DC.

The accompanied test probe assembly meets UL/IEC/EN61010-031 Ed. 2.0 to the same meter ratings or better. IEC 61010-031 requires exposed conductive test probe tips to be  $\leq 4\text{mm}$  for CAT III & CAT IV ratings. Refer to the category markings on your probe assemblies as well as on the add-on accessories (like detachable Caps or Alligator Clips), if any, for applicable rating changes.

### TERMS IN THIS MANUAL

**WARNING** identifies conditions and actions that could result in serious injury or even death to the user.

**CAUTION** identifies conditions and actions that could cause damage or malfunction in the instrument.











### **WARNING**

This manual contains information and warnings that must be followed for operating the meter safely and maintaining the meter in a safe operating condition. If the meter is used in a manner not specified by the manufacturer, the protection provided by the meter may be impaired.

Observe proper safety precautions when working with voltages above 30 Vrms, 42.4 Vpeak or 60 VDC. These voltage levels pose a potential shock hazard to the user. Do not expose this product to rain or moisture. The meter is intended only for indoor use.

Keep your hands/fingers behind the hand/finger barriers (of the meter and the test probe assembly, where applicable) that indicate the limits of safe access of the hand-held parts during measurements. Inspect lead wires, connectors, and probes for damaged insulation or exposed metal periodically. If any defects are found, replace them immediately. Optional offer premium silicon test lead wires, at agent's discretion, equip with white inner insulation layer as wear indicator. Do not use them if the wear indicator has become visible. Only use the probe assembly provided with the meter or a UL Listed Probe Assembly to the same meter ratings or better.

## INTERNATIONAL SYMBOLS

	Marking of Electrical and Electronic Equipment (EEE). Do not dispose of this product as unsorted municipal waste. Contact a qualified recycler
	Caution! Refer to the explanation in this Manual
	Caution! Possibility of electric shock
	Earth (Ground)
	Meter protected throughout by Double Insulation or Reinforced insulation
	Fuse
	Direct Current (DC)
	Alternating Current (AC)
	Three-phase Alternating Current
	Application around and removal from hazardous live conductors is permitted

## BRIEF INFORMATION ON MEASUREMENT CATEGORIES

**Measurement Category IV** is applicable to test and measuring circuits connected at the source of the building's low-voltage MAINS installation. Examples are measurements on devices installed before the main fuse or circuit breaker in the building installation.

**Measurement Category III** is applicable to test and measuring circuits connected to the distribution part of the building's low-voltage MAINS installation. Examples are measurements on distribution boards (including secondary meters), circuit-breakers, cables, bus-bars, junction boxes, switches, socket-outlets, stationary motors in the fixed installation, and equipment for industrial use.

**Measurement Category II** is applicable to test and measuring circuits connected directly to utilization points (socket outlets and similar points) of the low-voltage MAINS installation. Examples are measurements on MAINS CIRCUITS of household appliances, portable tools and similar equipment.

## 2) CENELEC DIRECTIVES

The instruments conform to CENELEC Low-voltage directive 2014/35/EU, Electromagnetic compatibility directive 2014/30/EU and RoHS directive 2015/863/EU.

## 3) PRODUCT DESCRIPTION

This user's manual uses only representative model(s) for illustrations. Please refer specification details for function availability to each model.

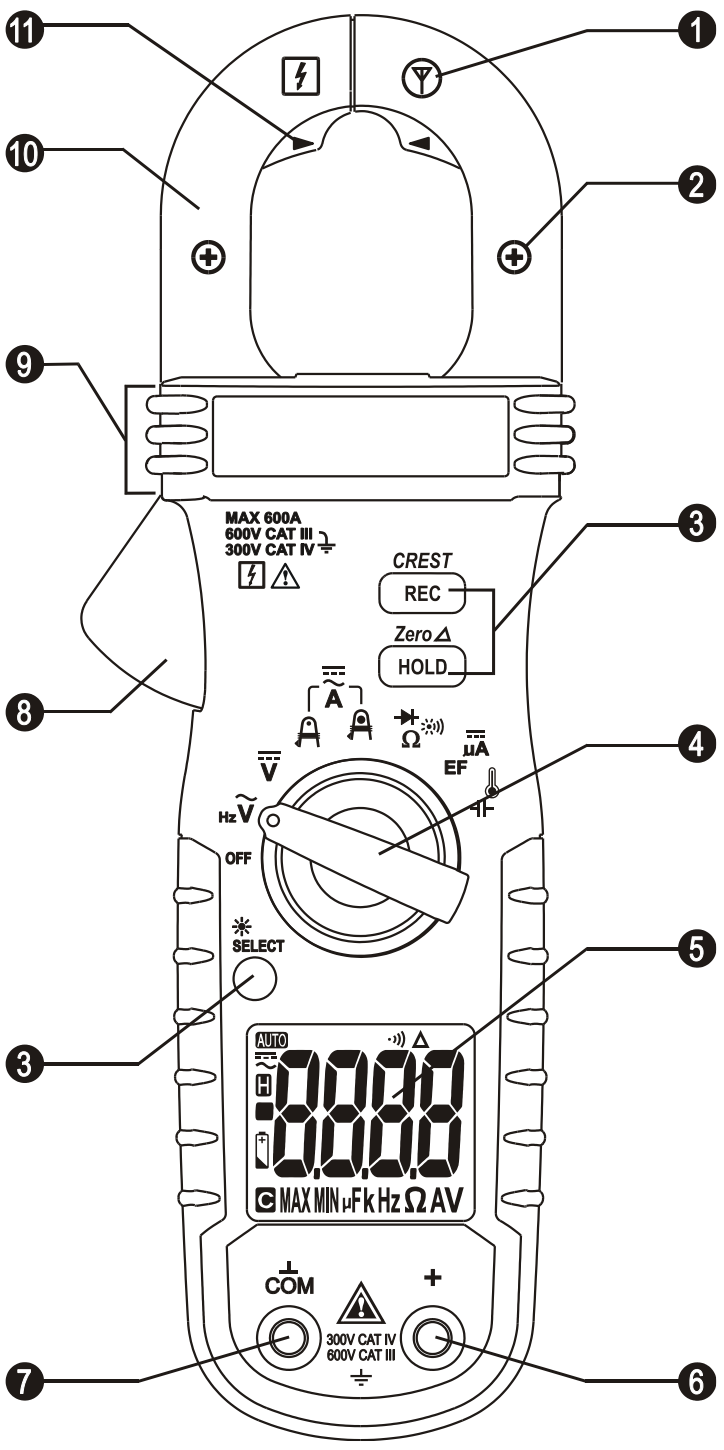

- 1) Antenna area for Non-Contact EF-Detection
- 2) Jaw center indicator (with DCA polarity for Models 037 & 035), at where best current accuracy is specified
- 3) Push-buttons for special functions & features.
- 4) Rotary Selector to turn the power ON/OFF and select a function
- 5) 3-5/6 digits 6000 counts numeric LCD display
- 6) Input Jack for all functions EXCEPT non-invasive Current functions
- 7) Common (Ground reference) Input Jack for all functions EXCEPT the Clamp-on Current and Non-Contact EF-Detection functions
- 8) Jaw trigger for opening the clamp jaw
- 9) Hand/Finger Barrier to indicate the limits of safe access of the meter
- 10) Clamp Jaw for Clamp-on Current magnetic field pick up

11) Additional center indicator for AmpTip™ Low-current functions, at where best AmpTip™ current accuracy is specified

**4) OPERATION**

**WARNING**

Before and after hazardous voltage measurements, test the voltage function on a known source such as line voltage to determine proper meter functioning

## ACV; Line-level Hz (Models 037 & 033 only)

Inputs are made through the test lead terminals **COM/+**. Defaults at **ACV** Function. Press **SELECT** button momentarily to select **Line-level Hz** function.

### Note:

**ACV** and **Line-level Hz** functions are equipped with low-pass filter, and are capable of dealing with **VFD** (Variable Frequency Drives) signals. It also improves reading stability in noisy electrical environments.

## DCV

Inputs are made through the test lead terminals **COM/+**.

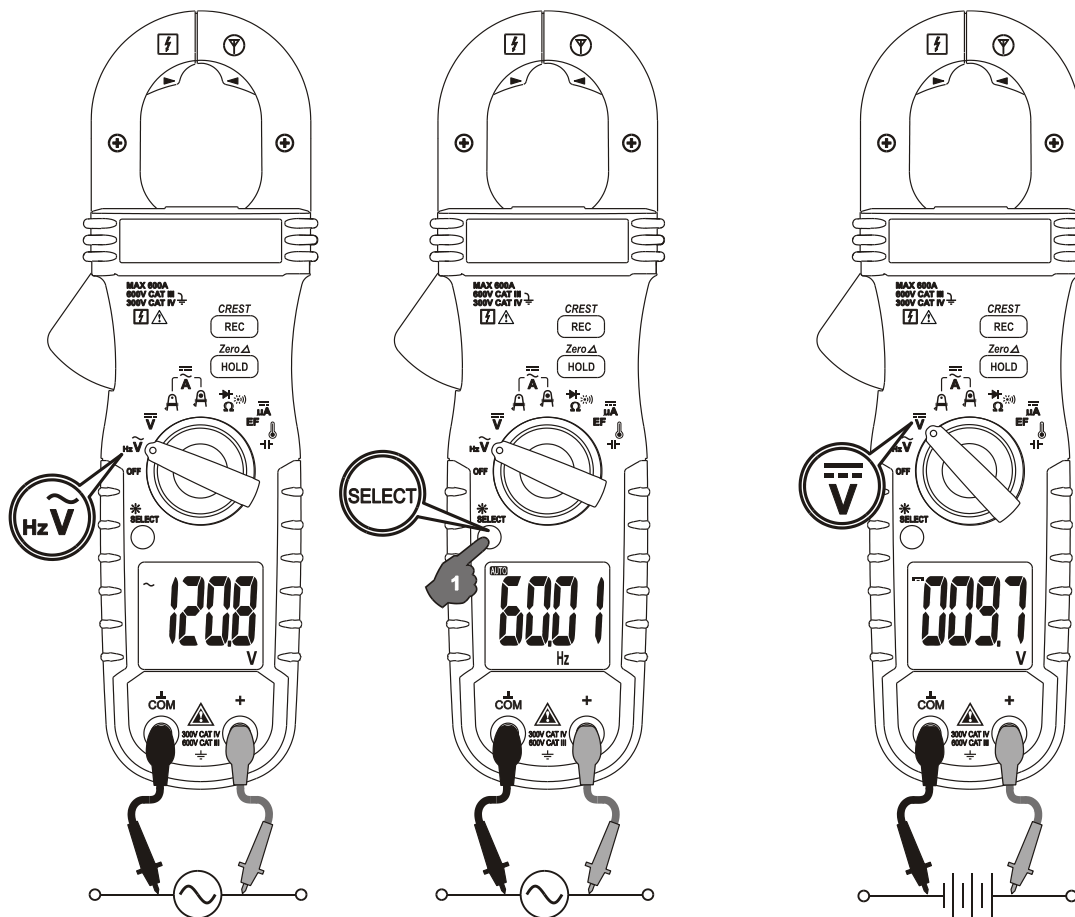

## Clamp-on Current Measurements: Application & Removal Of The Jaws

Press the jaw trigger and clamp the jaws around conductor(s) of only one single pole of a circuit for load current measurements. Make sure the jaws are completely closed, or else it will introduce measurement errors. Enclosing conductor(s) of more than one pole of a circuit may result in differential current (like identifying leakage current) measurements. Align the conductor(s) to the Jaws center indicators (Regular or

AmpTip™ indicators where applicable) as much as possible to get the best measuring accuracy. For removal, press the jaw trigger and remove the jaws from the conductor(s).

Adjacent current-carrying devices such as transformers, motors and conductor wires may affect measurement accuracy. Keep the jaws away from them as much as possible to minimize influence.

## **WARNING**

This Clamp-on meter series is designed to directly apply around or remove from uninsulated hazardous live conductors. But still, individual protective equipment must be used if hazardous live parts in the installation where measurement is to be carried out could be accessible. Do not use the meter to measure currents above the rated frequency (400Hz). Circulating currents may cause the magnetic circuits of the Jaws reach a hazardous temperature.

### **Clamp-on AmpTip™ ACA; AmpTip™ DCA (Models 035 & 037 only)**

Input is made via the clamp jaws where best accuracy is specified near the jaw TIP-CENTER area for low-current measurements of thin conductors. Defaults at **ACA**. Press **SELECT** button momentarily to select **DCA** for Models 035 & 037.

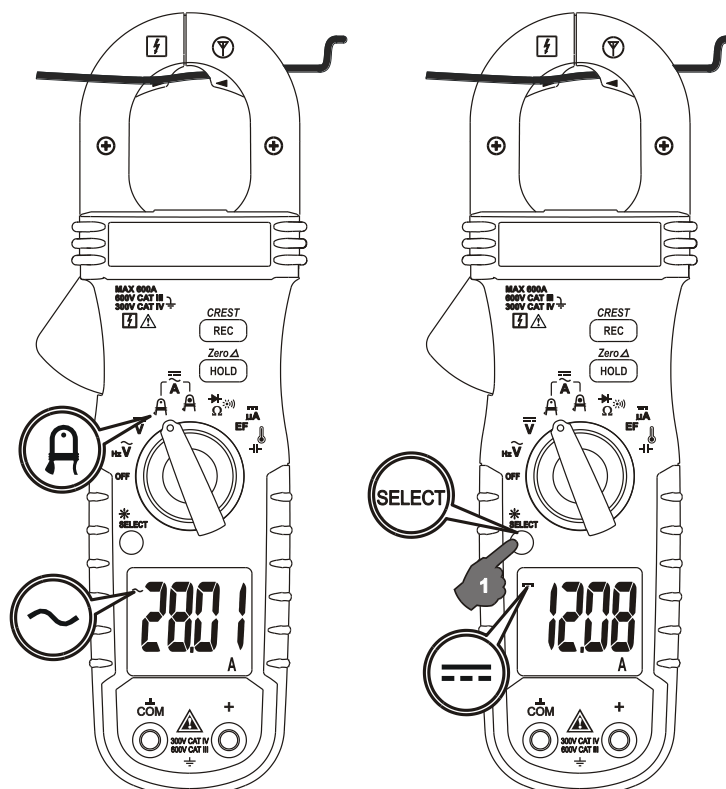

## Clamp-on Regular ACA; Regular DCA (Models 035 & 037 only)

Input is made via the clamp jaws where best accuracy is specified at the jaw CENTER area. Defaults at **ACA**. Press **SELECT** button momentarily to select **DCA** for Models 035 & 037.

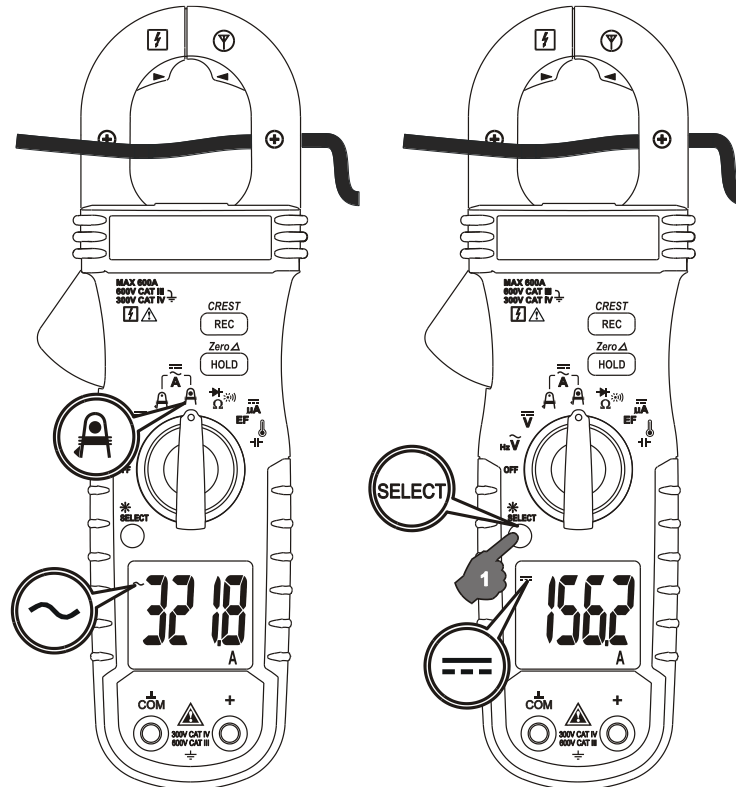

## $\Omega$ Resistance, $\rightarrow$ BeepLit™ Continuity, & $\rightarrow$ BeepLit™ Diode

Inputs are made through the test lead terminals **COM/+**. Defaults at  $\Omega$  Resistance. Press **SELECT** button momentarily to select the subject functions in sequence. For Models 035 & 031,  $\rightarrow$  BeepLit™ Diode function is located in an independent rotary switch position

### ⊙ $\rightarrow$ BeepLit™ Continuity

*This function is having improved convenience for checking wiring connections and operation of switches. Resistance threshold is being used. A continuous beep tone together with flashing display backlight indicate a complete wire. Such audible and visible indications improve continuity readabilities in noisy working environments.*

### ⊙ $\rightarrow$ BeepLit™ Diode

● **Reading indication:** Forward voltage drop (forward biased) for a good silicon diode is between 0.400V to 0.900V. A higher reading indicates a leaky diode (defective). A

zero reading indicates a shorted diode (defective). An over-range display indicates an open diode (defective). Reverse the test leads connections (reverse biased) across the diode. The digital display shows over-range if the diode is good. Any other readings indicate the diode is resistive or shorted (defective).

● **Beep-Alert & BeepLit™ indication:** When the display reading drops across 0.850V, the meter alerts a short beep to signal a reasonable forward voltage drop of common diodes. However, if the reading further drops below 0.100V, the meter gives a continuous beep tone together with flashing display backlight to indicate a shorted diode or a complete wire. It is similar to that of **BeepLit™ Continuity** function but **BeepLit™ Diode**, instead, is based on voltage threshold to indicate a complete wire.

## CAUTION

Using **Resistance**, **BeepLit™ Continuity** or **BeepLit™ Diode** function in a live circuit will produce false results and may damage the meter. In many cases, the suspected component(s) must be disconnected from the circuit to obtain an accurate measurement reading.

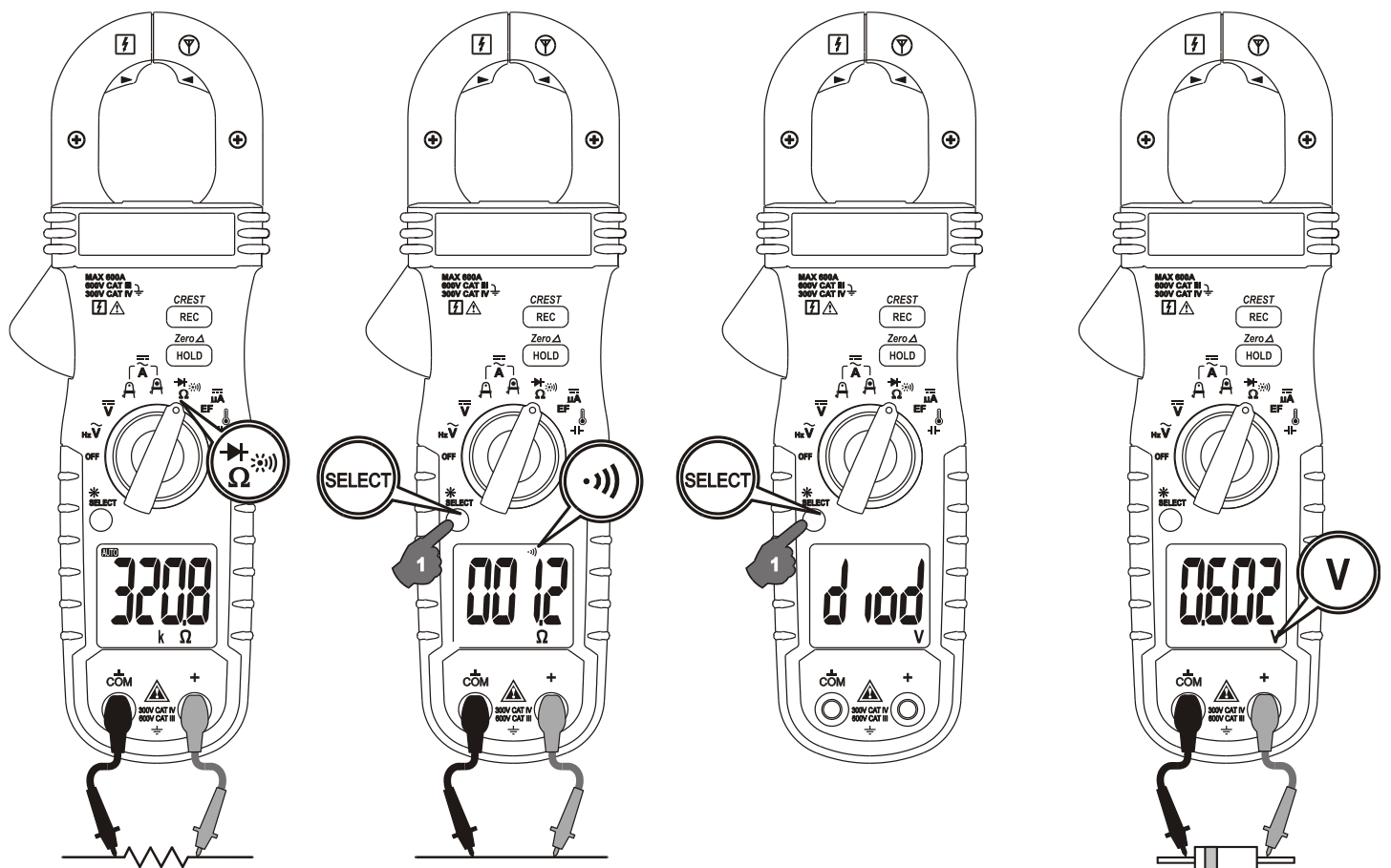



## EF-Detection of Electric Field

Defaults at high sensitivity **EF-H**. The meter displays “**EF-H**” when it is ready. If it is too sensitive for your applications, press **SELECT** button momentarily to select lower sensitivity “**EF-L**”. The detected Electric Field strength is indicated as a series of bar-graph segments on the display plus variable beep tones.

● **Non-Contact EF-Detection (NCV):** An antenna is located along the top-right end of the stationary clamp jaw, which detects electric field surrounds energized conductors. It is ideal for tracing live wiring connections, locating wiring breakage and to distinguish between live or earth connections.

● **Probe-Contact EF-Detection:** For more precise indication of live wires, such as distinguishing between Live and Ground connections, use one single probe to test via terminal **COM** for direct metal Probe-Contact EF-Detection to achieve the most distinctive indication.

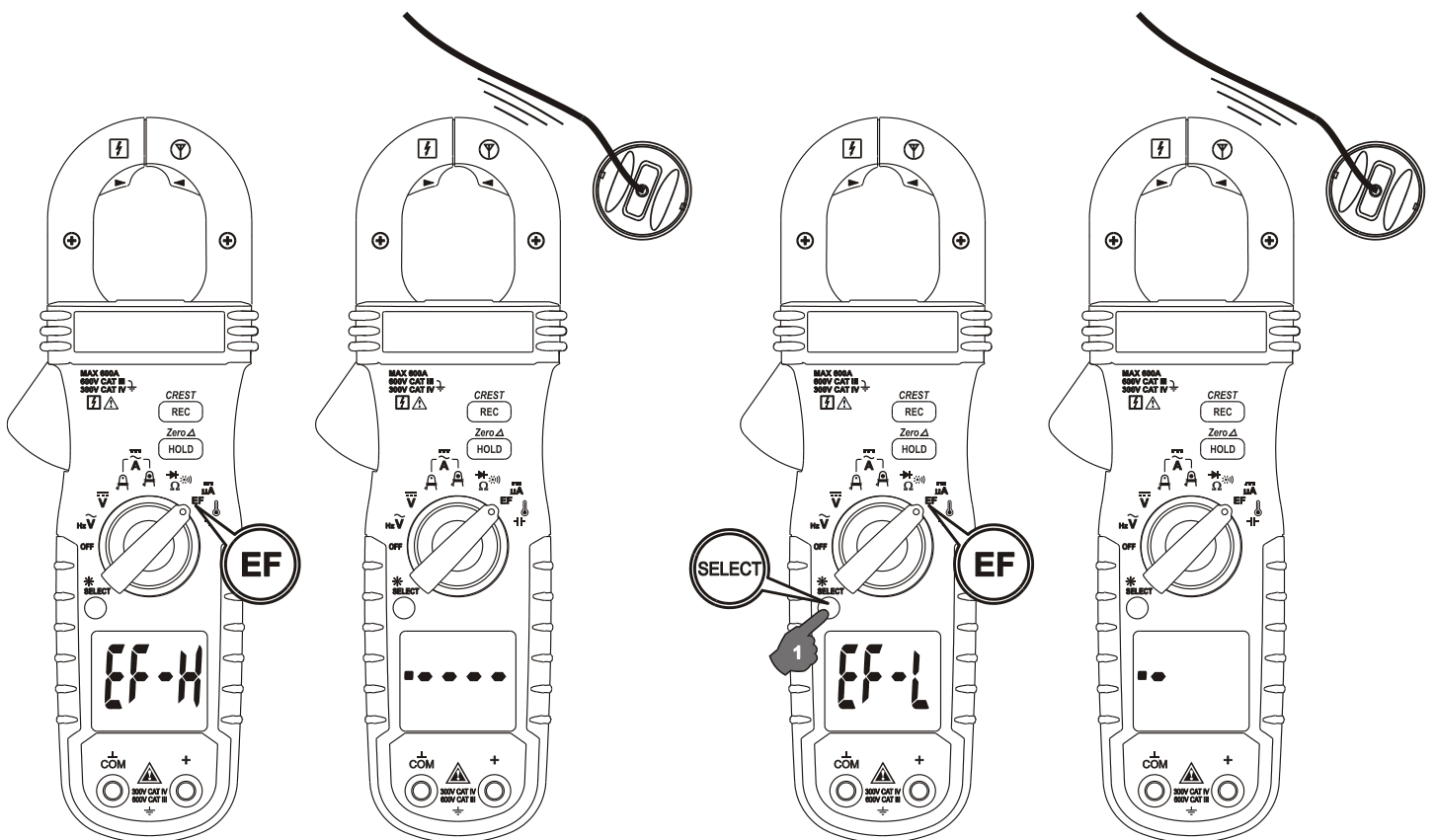

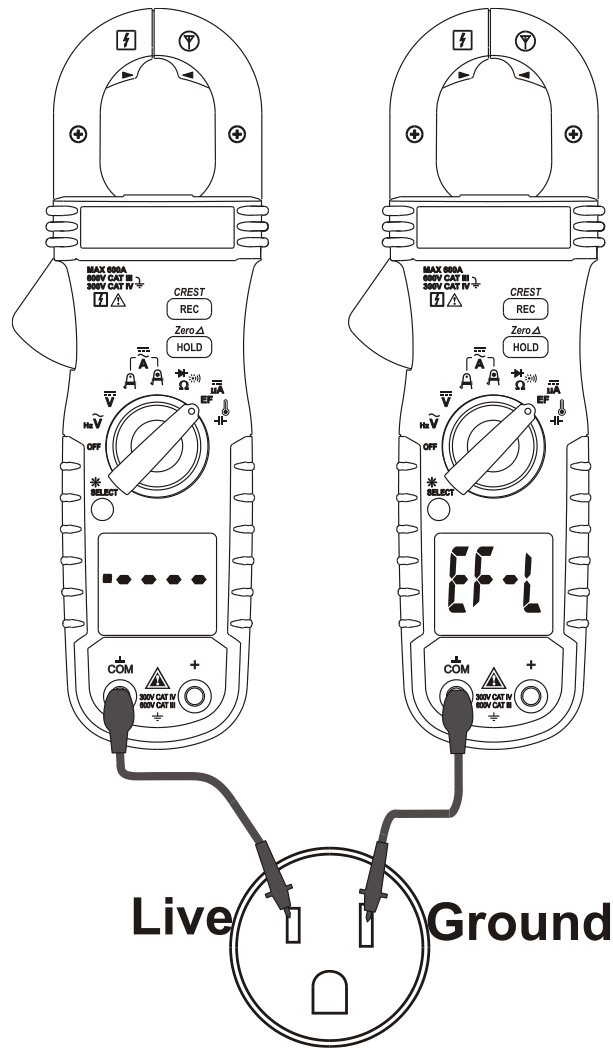

### DC $\mu$ A (Models 037 & 033 only)

Inputs are made through the test lead terminals **COM/+**. Defaults at **EF-Detection** function. Press **SELECT** button momentarily two times to select **DC $\mu$ A** function.

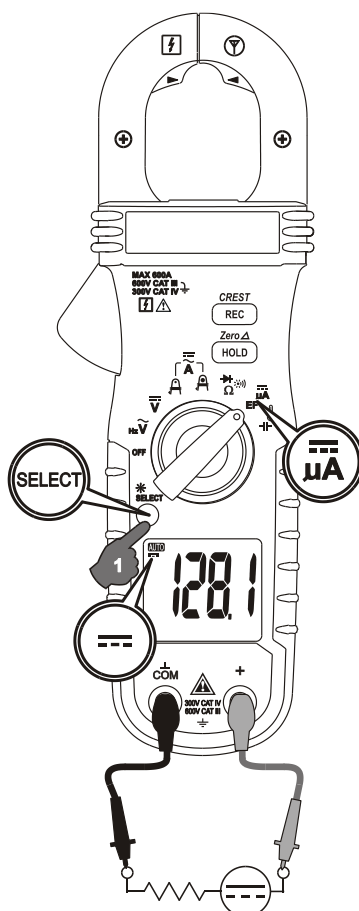

#### ● **Application notes:**

The **DC $\mu$ A** function is designed especially for HVAC/R flame sensor applications. The 0.1 $\mu$ A resolution is useful for identifying the minute current changes in flame detector applications. Flame signal current check should indicate steady flame signal of at least 2 $\mu$ A for a rectification type, or 1.5 $\mu$ A for an ultraviolet type (8 $\mu$ A for self checking systems). If a flame signal current with inadequate strength or fluctuation beyond 10%, check the following to avoid the risk of unwanted flame relay dropout :

For gas or oil flames (Minipeeper):

- ✓ Low supply voltage
- ✓ Detector location
- ✓ Defective detector wiring
- ✓ Dirty viewing windows
- ✓ Faulty Minipeeper

For oil flames (Photocell):

- ✓ *Detector location & wiring*
- ✓ *Smoky flame or poorly adjusted air shutter*
- ✓ *Faulty Photocell*
- ✓ *Temperature over 165 °F (74 °C) at photocell*

*For gas flames (Flame Rod):*

- ✓ *Ignition interference (A flame signal current difference with the ignition both on and off greater than  $0.5\mu\text{A}$  indicates the presence of ignition interference)*
- ✓ *Insufficient ground (must be at least 4 times the detector area)*
- ✓ *Flame lifting off burner head (ground), or not continuously in contact with the flame rod*
- ✓ *Temperature in excess of 600 °F (316 °C) at the flame electrode insulator causing short to ground.*

### **-H- Capacitance & Temperature (Models 037 & 033 only)**

Inputs are made through the test lead terminals **COM/+**. Defaults at **-H- Capacitance**. Press **SELECT** button momentarily to select **°C** (Celsius) and **°F** (Fahrenheit) in sequence (**°F** selection can be left out as factory calibration default for countries that only accept metric units).

### **Note**

*Be sure to insert the banana plug type-K temperature bead probe Bkp60 with correct **+** **-** polarities. Banana pins to type-K socket adapter Bkb32 (Optional purchase) can be used to accept other type-K probes using standard miniature plug.*

*Temperature accuracies assume meter interior has the same temperature of the ambient (isothermal stage) for a correct junction voltage compensation. Allow the meter and the type-K probe set to reach isothermal stage for a significant change of ambient temperature. It can take up to an hour for changes  $> 5^{\circ}\text{C}$ .*

### **CAUTION**

*Discharge capacitor(s) before making capacitance measurements. Large value capacitors should be discharged through an appropriate resistance load. Using Capacitance function in a live circuit will produce false results and may damage the meter. In many cases the suspected component(s) must be disconnected from the circuit to obtain accurate measurement readings.*

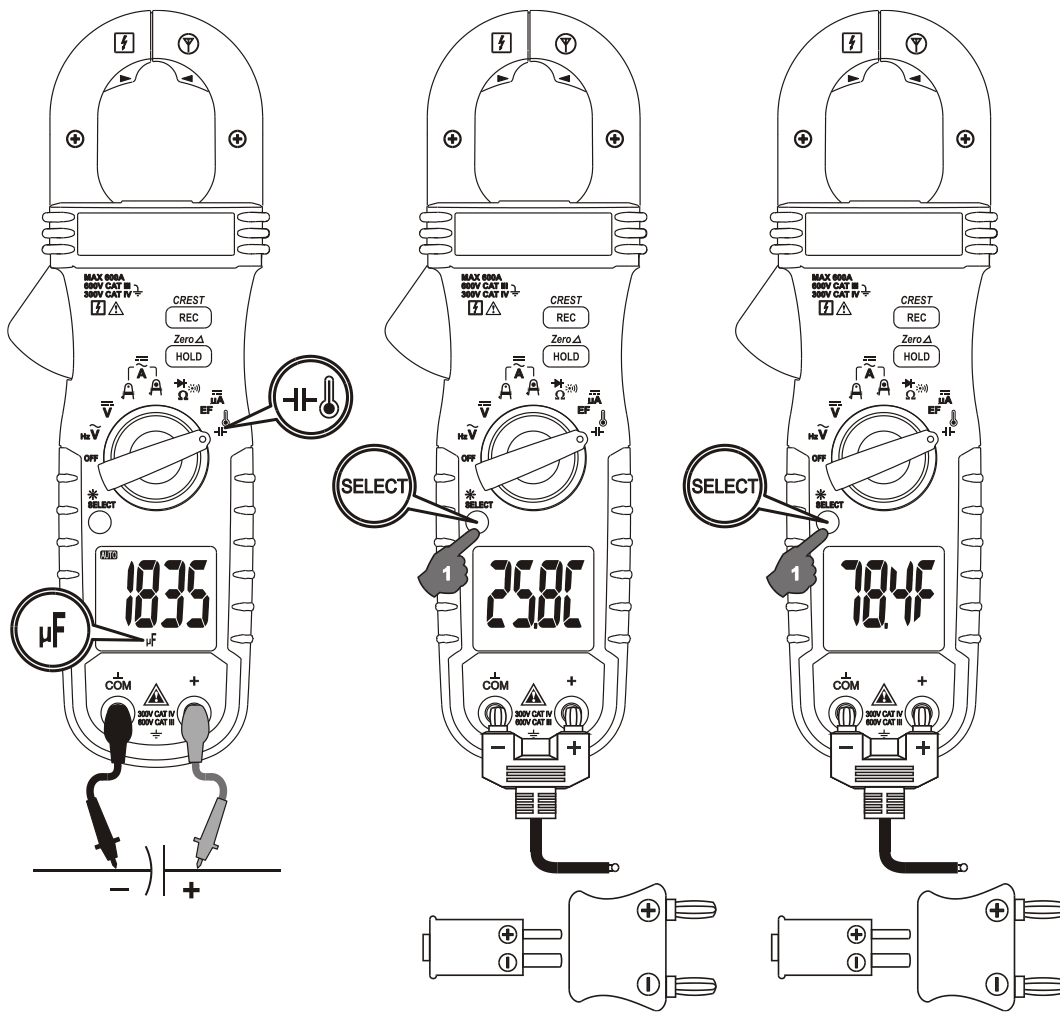

**HOLD**

**HOLD** feature freezes the display for later view. LCD “**H**” turns on. Press the **HOLD** button momentarily to toggle the **HOLD** feature.

**Relative $\Delta$  mode; DC-Zero mode (Models 035 & 037 only)**

⊙ **Relative $\Delta$**  mode allows the user to offset the meter consecutive measurements with the main display displaying reading as the reference value. LCD “ **$\Delta$** ” turns on. Press the  **$\Delta$**  (**HOLD**) button for one second or more to toggle **Relative $\Delta$**  mode. When in **DCA** functions (Models 035 & 037 only), however, **DC-Zero** mode instead will be activated.

⊙ **DC-Zero** mode (Models 035 & 037 only) is a feature to temporarily offset **DCA** residue readings caused by residual magnetic field of the jaws in **DCA** functions. Press the **Zero** (**HOLD**) button for one second or more to apply. The meter displays “**dc\_0**” on each activation before continuing measurements. Apply this mode repeatedly to get a zero reading before making any **DCA** measurements for best measuring accuracy. The meter will give 3 short beeps, however, to warn for null activation if the display reading is beyond a reasonable residue of -5 to 5 DCA.

**RECORD mode**

Press **REC** button momentarily to activate **MAX/MIN** recording mode. LCD **MAX** & **MIN** turn on. The meter beeps when new **MAX** (maximum) or **MIN** (minimum) reading is updated. Press the button momentarily to read the **MAX**, **MIN**, and **MAXMIN** (active measurement) readings in sequence. Press the button for 1 second or more to exit this mode. Auto-Power-Off is disabled automatically in this mode.

**5ms CREST mode**

Press **CREST** button for one second or more to activate **CREST** mode (Instantaneous PEAK-HOLD) to capture current or voltage peak values in duration as short as 5ms. LCD **C** & **MAX** turn on. The meter beeps when new **C<sub>MAX</sub>** (maximum) or **C<sub>MIN</sub>** (minimum) reading is updated. Press the button momentarily to toggle the **C<sub>MAX</sub>** and **C<sub>MIN</sub>** readings. Press the button for 1 second or more to exit this mode. Auto-Power-Off is disabled automatically in this mode.

**LCD Backlight and Auto-Backlight-Off (ABO)**

Press the **SELECT** button for 1 second or more to toggle the LCD backlight. The **ABO** mode turns the LCD backlight off automatically after idling for 10 minutes to extend battery life. See **Power-on Options** section for disabling **ABO**.

## **Intelligent Auto-Power-Off (APO)**

The **APO** mode turns the meter off automatically to extend battery life after idling 32 minutes of no specified activities, where applicable, below:

- 1) Rotary switch or push button operations
- 2) Significant measuring readings of above 8.5% of ranges
- 3) Non-over-range readings for Resistance, Continuity or Diode function
- 4) Non-zero readings for Hz function

In other words, the meter will intelligently reset the **APO** mode when it is under normal measurements. To wake up the meter from **APO**, press the **SELECT** button momentarily and release, or turn the rotary switch OFF and then back on. Always turn the rotary switch to the OFF position when the meter is not in use.

## **Power-on Options**

### **⊙ Disabling APO and ABO**

Press and hold the **SELECT** button while powering on the meter can disable both **APO** and **ABO** features temporarily during the power on session. The LCD will display “**dAPO**” to confirm selection before the **SELECT** button is released.

### **⊙ Shortening APO idling time for inspection**

Press and hold the **HOLD** button while powering on the meter can shorten the **APO** idling time to 5 seconds temporarily during the power on session. It is designed mainly for production inspection.

### **⊙ Showing all LCD segments for inspection**

Press and hold the **REC** button while powering on the meter can hold and show all LCD segments before the button is released. It is designed mainly for production inspection.

## **5) MAINTENANCE**

### ***WARNING***

To avoid electrical shock, disconnect the meter from any circuit, remove the test leads from the input jacks and turn OFF the meter before opening the case. Do not operate with open case.

## Trouble Shooting

If the instrument fails to operate, check batteries and test leads etc., and replace as necessary. Double check operating procedure as described in this user's manual. Refer to the LIMITED WARRANTY section for obtaining calibration, repairing or warranty service.

## Accuracy and Calibration

Accuracy is specified for a period of one year after calibration. Periodic calibration at intervals of one year is recommended to maintain meter accuracy.

## Cleaning and Storage

Periodically wipe the meter and the test probe assembly with a damp cloth and mild detergent. Do not use abrasives or solvents. Allow to dry completely before operating. If the meter is not to be used for periods of longer than 60 days, remove the batteries and store them separately

## Battery replacement

The meter uses standard 1.5V AAA Size (IEC R03) battery X 2

Loosen the 2 captive screws from the bottom case. Lift the bottom case. Replace the batteries. Replace the bottom case. Re-fasten the screws.

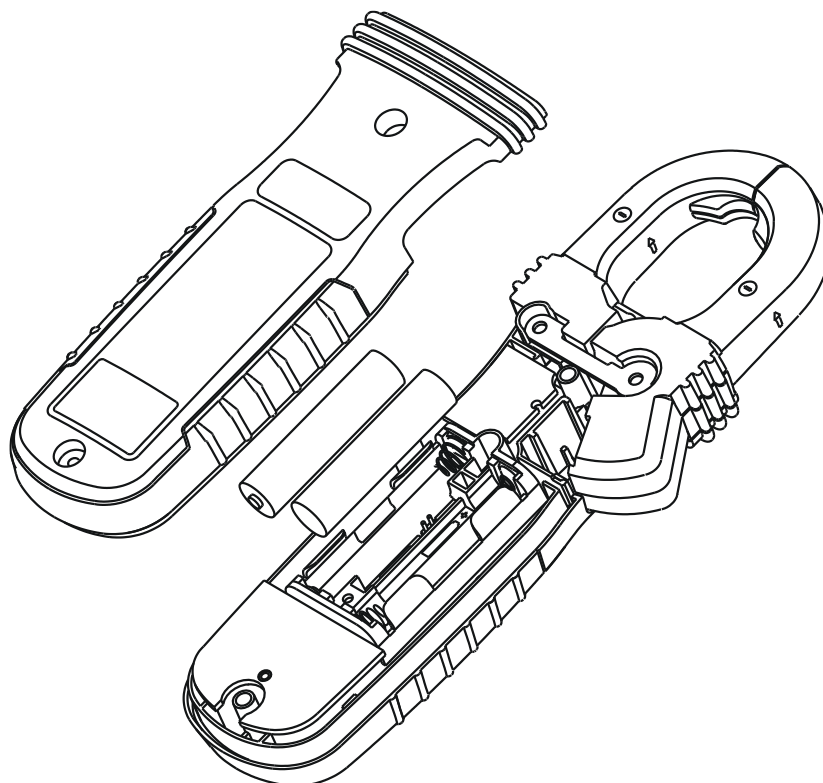



## GENERAL SPECIFICATIONS

**Display:** 3-5/6 digits 6000 counts

**Polarity:** Automatic

**Update Rate:** 5 per second nominal

**Operating Temperature:** 0°C to 40°C

**Relative Humidity:** Maximum relative humidity 80% for temperature up to 31°C decreasing linearly to 50% relative humidity at 40°C

**Pollution degree:** 2

**Storage Temperature:** -20°C to 60°C, < 80% R.H. (with battery removed)

**Altitude:** Operating below 2000m

**Temperature Coefficient:** nominal  $0.1 \times (\text{specified accuracy}) / ^\circ\text{C}$  @ (0°C -- 18°C or 28°C -- 40°C), or otherwise specified

**Sensing:** True RMS

**Safety:** Certified per IEC/UL/CSA\_C22.2\_#/EN standards:

61010-1 Ed. 3.0, 61010-2-032 Ed. 3.0, 61010-2-033 Ed. 1.0 & 61010-031 Ed. 2.0 to Measurement Categories CAT III 600V and CAT IV 300V ac & dc

**Transient Protection:** 6.0kV (1.2/50 $\mu$ s surge)

### Overload Protections:

Current via jaws: 600Adc/Aac rms at <400Hz

Voltage via terminals: 660Vdc / 920Vac rms

Other functions via terminals: 600Vdc/Vac rms

### E.M.C.: Meets EN61326-1:2013

DCA and ACA Functions, in an RF field of 1V/m:

Total Accuracy = Specified Accuracy + 40 digits at around 87MHz

DC $\mu$ A and Ohm Functions, in an RF field of 1V/m:

Total Accuracy = Specified Accuracy + 25 digits

Other Functions, in an RF field of 3V/m:

Total Accuracy = Specified Accuracy + 20 digits

**Power Supply:** 1.5V AAA Size battery X 2

**Power Consumption:** Typical 14mA for Current functions of Models 037 & 035; 4mA for others

### Low Battery Indication:

Below approx. 2.85V for Capacitance & Hz

Below approx. 2.5V for other functions

**APO Timing:** Idle for 32 minutes

**APO Consumption:** 5 $\mu$ A typical

**Dimension (LxWxH):** 188 x 66 x 32mm

**Weight:** 202g for Models 037 & 035; 158g for Models 033 & 031

**Jaw opening & Conductor diameter :** 26mm max

**Accessories:** Test lead set, User's manual, Soft carrying pouch, Bkp60 banana plug type-K thermocouple (Models 037 & 033 only),

**Optional purchase accessories:** BKB32 banana plug to type-K socket plug adaptor (Models 037 & 033 only)

**Special Features:** AmpTip™ low-current range; MAX/MIN Recording mode; MAX/MIN Crest (Peak-Hold) mode; Relative-Zero mode; Display Hold; EF-Detection (NCV); BeepLit™ Feature

## Electrical Specifications

Accuracy is  $\pm$ (% reading digits + number of digits) or otherwise specified, at 23°C  $\pm$  5°C.

Maximum Crest Factor < 2 : 1 at full scale & < 4 : 1 at half scale or otherwise specified, and with frequency spectrum not exceeding the specified frequency bandwidth for non-sinusoidal waveforms.

## DC Voltage

RANGE	Accuracy
600.0V	1.0% + 5d

Input Impedance: 10M $\Omega$ , 100 pF nominal

## AC Voltage (Low-Pass Filter)

RANGE	Accuracy
50Hz ~ 60Hz	
600.0V	1.5% + 5d

Input Impedance: 10M $\Omega$ , 100 pF nominal

## CREST (Peak-Hold)

Applicability: Voltage and Non-invasion Current functions

Accuracy: Add +/- 250 digits to specified accuracy for changes > 5ms in duration

## BeepLit™ Continuity Tester

Continuity Threshold: Between 30 $\Omega$  and 480 $\Omega$

Continuity ON Response Time: 15ms approx.

Audible Indication: Beep sound

Visible Indication: LCD Backlight

**Ohm**

RANGE	Accuracy
600.0Ω, 6.000kΩ (All models)	1.0% + 5d
60.00kΩ, 600.0kΩ, 6000kΩ (Models 037 & 033 only)	

Open Circuit Voltage: 1.0VDC typical

**Capacitance (Models 037 & 033 only)**

RANGE	Accuracy <sup>1)</sup>
200.0μF, 2500μF	2.0% + 4d

<sup>1)</sup>Accuracies with film capacitor or better

**BeepLit™ Diode Tester**

RANGE	Accuracy
3.000V	1.5% + 5d

Test Current: 0.3mA typically

Open Circuit Voltage: < 3.5VDC typically

Short Beep Alert Threshold: Drop across 0.850V

BeepLit™ ON Threshold: < 0.100V

Audible Indication: Beep sound

Visible Indication: LCD Backlight

**DCμA (Models 037 & 033 only)**

RANGE	Accuracy	Burden Voltage
200.0μA, 2000μA	1.0% + 5d	3.5mV/μA

**Temperature (Models 037 & 033 only)**

RANGE	Accuracy <sup>1) 2)</sup>
-40.0 °C ~ 99.9 °C	1.0% + 1.0°C
100 °C ~ 400 °C	1.0% + 1°C
-40.0 °F ~ 211.8 °F	1.0% + 2.0°F
212 °F ~752 °F	1.0% + 2°F

<sup>1)</sup>Accuracies assume meter interior has the same temperature of the ambient (isothermal stage) for a correct junction voltage compensation. Allow the meter and the type-K probe set to reach isothermal stage for a significant change of ambient temperature. It can take up to an hour for changes > 5°C.

<sup>2)</sup>Type-K thermocouple range & accuracy not included

**Clamp-on AmpTip™ ACA**

RANGE	Accuracy <sup>1)</sup>
50Hz ~ 60Hz	
60.00A	1.0% + 5d

<sup>1)</sup>Induced error from adjacent current-carrying conductor:

<0.01A/A for Models 037, 035

<0.06A/A for Models 033, 031

**Clamp-on AmpTip™ DCA (Models 037 & 035 only)**

RANGE	Accuracy <sup>1) 2) 3)</sup>
60.00A	1.0% + 5d

<sup>1)</sup>Induced error from adjacent current-carrying conductor: <0.01A/A

<sup>2)</sup>Specified with DC-Zero mode applied to offset the non-zero residual readings, if any

<sup>3)</sup>Add 5d to the specified accuracy @ < 4A

**Clamp-on Regular ACA**

RANGE	Accuracy <sup>1) 2)</sup>
50Hz ~ 100Hz	
600.0A	1.5% + 5d
100Hz ~ 400Hz	
600.0A	2.0% + 5d

<sup>1)</sup>Induced error from adjacent current-carrying conductor:

<0.1A/A for Models 037, 035

<0.6A/A for Models 033, 031

<sup>2)</sup>For Models 033, 031, specified accuracy is for measurements made at the jaw center. When the conductor is not positioned at the jaw center, add 2% to specified accuracy for position errors

**Clamp-on Regular DCA (Models 037 & 035 only)**

RANGE	Accuracy <sup>1) 2)</sup>
600.0A	2.0% + 5d

<sup>1)</sup>Induced error from adjacent current-carrying conductor: <0.1A/A

<sup>2)</sup>Specified with DC-Zero mode applied to offset the non-zero residual readings, if any

**Hz Line Level Frequency (Models 037 & 033 only)**

Function	Sensitivity <sup>1)</sup> (Sine RMS)	Range
600V	50V	5.00Hz ~ 999.9Hz

Accuracy: 1%+5d

<sup>1)</sup>DC-bias, if any, not more than 50% of Sine RMS

## Non-Contact EF-Detection

Bar-Graph Indication	EF-H (Hi Sensitivity)	EF-L (Lo Sensitivity)
	Typical Voltage (Tolerance)	
-	10V (2V ~ 20V)	40V (10V ~ 70V)
--	20V (4V ~ 40V)	80V (20V ~ 140V)
---	40V (8V ~ 70V)	160V (40V ~ 280V)
----	80V (16V ~ 140V)	320V (80V ~ 560V)
-----	160V (>40V)	500V (>160V)

Indication: Bar-graph segments & audible beep tones proportional to the field strength

Detection Frequency: 50/60Hz

Detection Antenna: Inside the top side of the stationary jaw

Probe-Contact EF-Detection: For more precise indication of live wires, such as distinguishing between live and ground connections, use one single probe to test via terminal COM for direct metal Probe-Contact EF-Detection to achieve the most distinctive indication.

- NOTE -

## LIMITED WARRANTY

BRYMEN warrants to the original product purchaser that each product it manufactures will be free from defects in material and workmanship under normal use and service within a period of one year from the date of purchase. BRYMEN's warranty does not apply to accessories, fuses, fusible resistors, spark gaps, varistors, batteries or any product which, in BRYMEN's opinion, has been misused, altered, neglected, or damaged by accident or abnormal conditions of operation or handling.

To obtain warranty service, contact your nearest BRYMEN authorized agent or send the product, with proof of purchase and description of the difficulty, postage and insurance prepaid, to BRYMEN TECHNOLOGY CORPORATION. BRYMEN assumes no risk for damage in transit. BRYMEN will, at its option, repair or replace the defective product free of charge. However, if BRYMEN determines that the failure was caused by misused, altered, neglected, or damaged by accident or abnormal conditions of operation or handling, you will be billed for the repair.

THIS WARRANTY IS EXCLUSIVE AND IS IN LIEU OF ALL OTHER WARRANTIES, EXPRESSED OR IMPLIED, INCLUDING BUT NOT LIMITED TO ANY IMPLIED WARRANTY OR MERCHANTABILITY OR FITNESS FOR A PARTICULAR PURPOSE OR USE. BRYMEN WILL NOT BE LIABLE FOR ANY SPECIAL, INDIRECT, INCIDENTAL OR CONSEQUENTIAL DAMAGES.



BRYMEN TECHNOLOGY CORPORATION

TEL:+886 2 2226 3396

FAX:+886 2 2225 0025

<http://www.brymen.com>



PRINTED ON RECYCLABLE PAPER, PLEASE RECYCLE

COPYRIGHT © MMXVIII Btc,

ALL RIGHTS RESERVED

P/N: 7M1C-1571-0000

PRINTED IN TAIWAN