

Measure Everything from AC, DC and 3-Phase Power Sources to Standby Power

The optimal power meter lineup for all applications

POWER METER PW3337/PW3336



POWER METER PW3335



AC/DC POWER HITESTER 3334



POWER HITESTER 3333



Advancing the Standard for Power Measurement

The best performing instruments for power measurement on production lines, in laboratories, and in research facilities.

Hioki delivers the optimal power testing solutions based on use case conditions, practical application, and accuracy.

Three-phase Power Meter

The PW3337 and PW3336 are suitable for a wide variety of connections, such as measuring three-phase circuits and single-phase 2-wire multiple circuits.

There is little internal resistance for the current input, and large currents up to 65 A can be measured with great accuracy.



PW3337 (3ch)



PW3336 (2ch)

Single-phase Power Meter

The PW3335 provides highly accurate measurements for everything from standby power to operating power.

Compliant with the IEC62301 measurement standard for standby power, it is capable of measuring current as low as 10 μ A.

Designed for power consumption testing, the 3334 and 3333 are guaranteed for accuracy for up to 3 years.



PW3335 (1ch)



3334 (1ch)



3333 (1ch)

Basic Accuracy and Frequency Bands

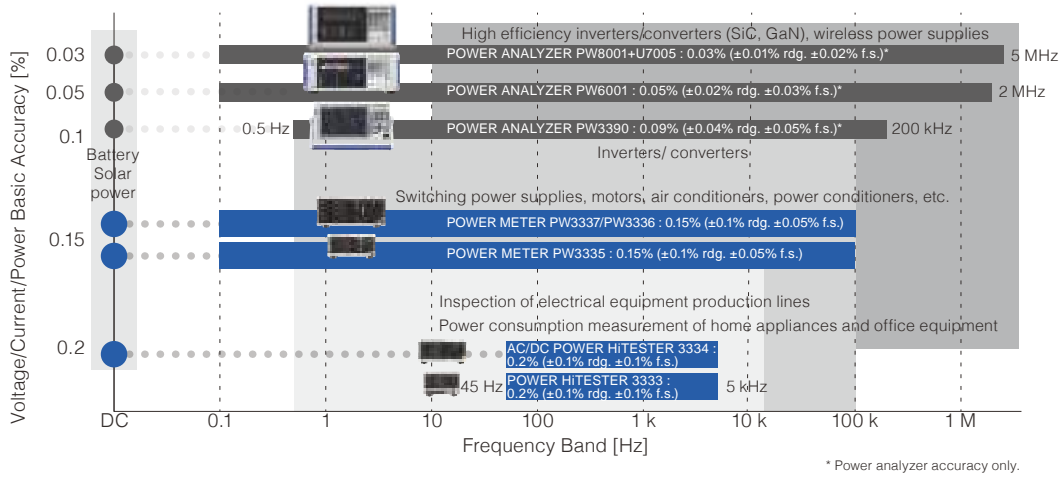

Effective Measurement Range

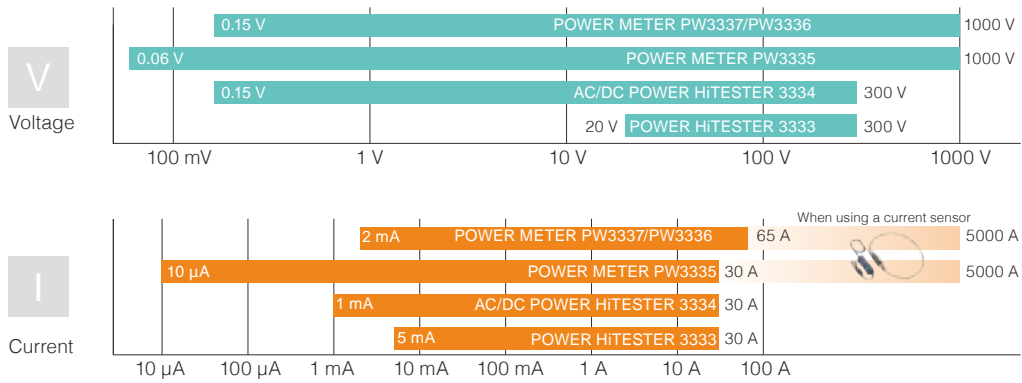

Comparison Chart

	PW3337	PW3336	PW3335	3334	3333	
No. of channels	3	2	1	1	1	
Supported connections	Three-phase, three-phase + single-phase, single-phase x 3, DC x 3	Three-phase, single-phase x 2, DC x 2	Single-phase, DC	Single-phase, DC	Single-phase	
Effective measurement range, voltage	0.15 V to 1000 V		0.06 V to 1000 V	0.15 V to 300 V	20 V to 300 V	
Effective measurement range, current	2 mA to 65 A		10 µA to 30 A	1 mA to 30 A	5 mA to 30 A	
Frequency band	DC, 0.1 Hz to 100 kHz			DC, 45 Hz to 5 kHz	45 Hz to 5 kHz	
Basic accuracy, AC (Voltage, current, power)	$\pm 0.1\%$ rdg. $\pm 0.05\%$ f.s.			$\pm 0.1\%$ rdg. $\pm 0.1\%$ f.s.	$\pm 0.1\%$ rdg. $\pm 0.2\%$ f.s.	
Basic accuracy, DC (Voltage, current, power)	$\pm 0.1\%$ rdg. $\pm 0.1\%$ f.s.			$\pm 0.1\%$ rdg. $\pm 0.2\%$ f.s.	-	
Integrated power measurement	Yes			Yes	-	
Harmonic measurement	IEC61000-4-7 compliant			-	-	
Current sensor input	Yes		PW3335-03, -04	-	-	
Interface	LAN	Yes			-	
	RS-232C	Yes		PW3335, -02, -03, -04	Yes	
	GP-IB	PW3337-01, -03	PW3336-01, -03	PW3335-01, -04	3334-01	3333-01
	D/A output	PW3337-02, -03	PW3336-02, -03	PW3335-02, -04	Yes	

Features

POWER METER PW3337/PW3336

Accurate measurement of power for three-phase equipment, through direct input up to 1000 V AC/DC / 65 A.



PW3337-03 Front Panel

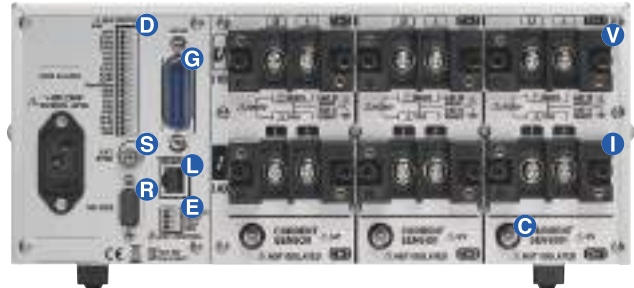

PW3337-03 Rear Panel



Maximum 65 A input.
Cable terminals are fixed securely
with large screws on the terminal block.

- Voltage/current/power basic accuracy of $\pm 0.1\%$ *
- Direct input up to 1000 V AC/DC / 65 A
- Harmonic measurement as standard feature, IEC61000-4-7 compliant
- Little instrument loss, even with large currents. DCCT input with an input resistance of 1 m Ω or less.
- Power factor effect of $\pm 0.1\%$ f.s. delivers highly accurate measurements even for no-load testing of transformers with a low power factor
- Measurement of multiple connections in the optimal range for each due to independent ranges for each channel
- Measure up to 5000 A AC with optional current sensor



PW3336-03
Rear Panel

POWER METER PW3335

Highly accurate AC/DC measurements from standby power to operating power



PW3335-04 Front Panel

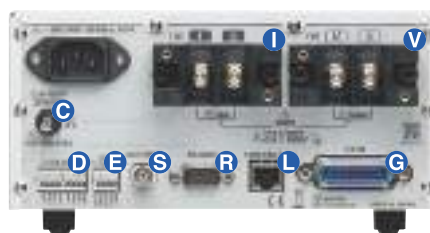

PW3335-04 Rear Panel



Half-rack Size to Save Space



For development/production lines for
electrical equipment

- Voltage/current/power basic accuracy $\pm 0.1\%$ *
- Highly accurate AC/DC measurements from standby power to operating power
- Accuracy guaranteed throughout a wide range, from 10 μ A to 30 A and 60 mV to 1000 V AC/DC
- Harmonic measurement as standard feature, IEC61000-4-7 compliant
- Compliant with the IEC62301 and EN50564 measurement standards for standby power
- Power factor effect of $\pm 0.1\%$ f.s. delivers highly accurate measurements even for no-load testing of transformers with a low power factor
- Accurate measurement of fluctuating electric power thanks to auto range integration with guaranteed accuracy for measurements while range switching
- Measure up to 5000 A AC with optional current sensor (PW3335-03, -04)

V Voltage input terminal	I Current input terminal	L LAN connector	R RS-232C connector	G GP-IB connector
D D/A output terminal	C Current sensor input terminal	S Synchronous control terminal	E External control terminal	

* For complete details, please refer to the specifications

AC/DC POWER HiTESTER 3334

Measurement of power consumption and integrated power for battery-operated equipment, home appliances, and office equipment



3334-01 Front Panel

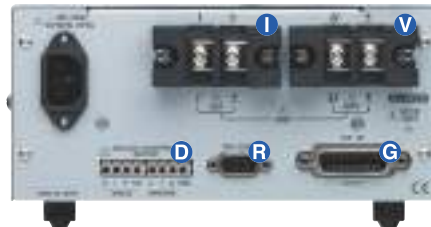

3334-01 Rear Panel

- Accuracy guaranteed up to 3 years
- Compliant with the SPECpower® server power evaluation test

POWER HiTESTER 3333

Low-price model for measurement of power consumption on production/inspection lines



3333-01 Front Panel

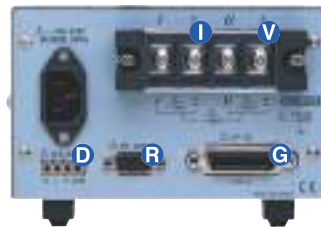

3333-01 Rear Panel

- Compact model for saving space, even when added to a system
- Accuracy guaranteed up to 3 years

Dimensional Drawings

Units: mm

PW3337
PW3336

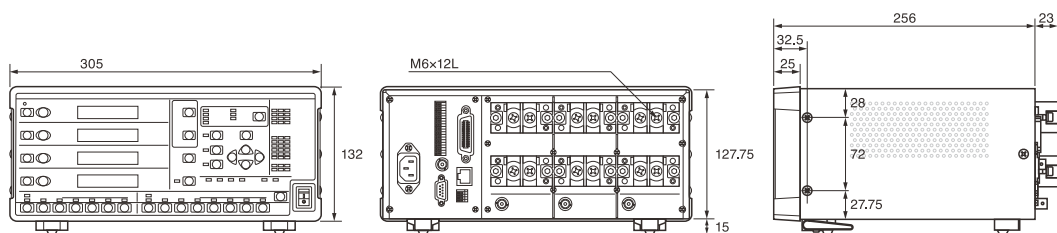

PW3335

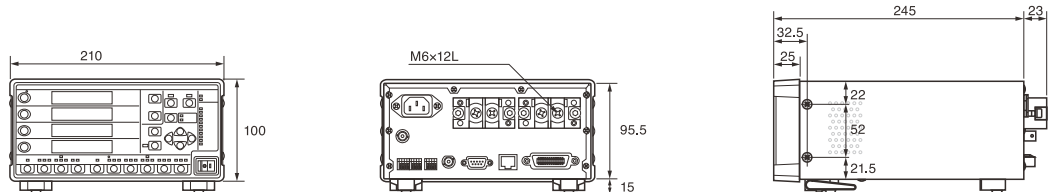

3334

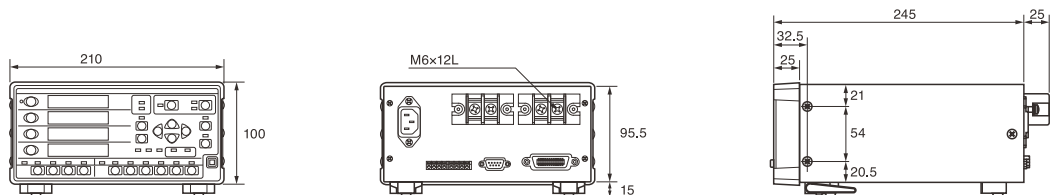

3333

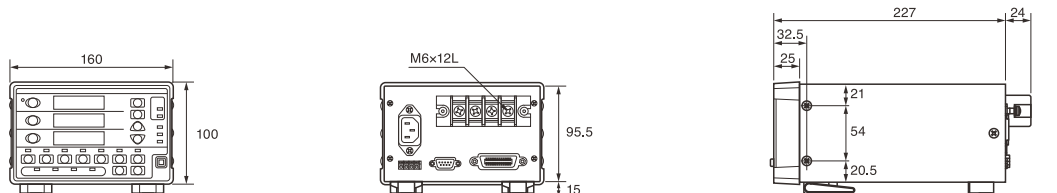

Applications

Inspection of Electrical Equipment Production Lines

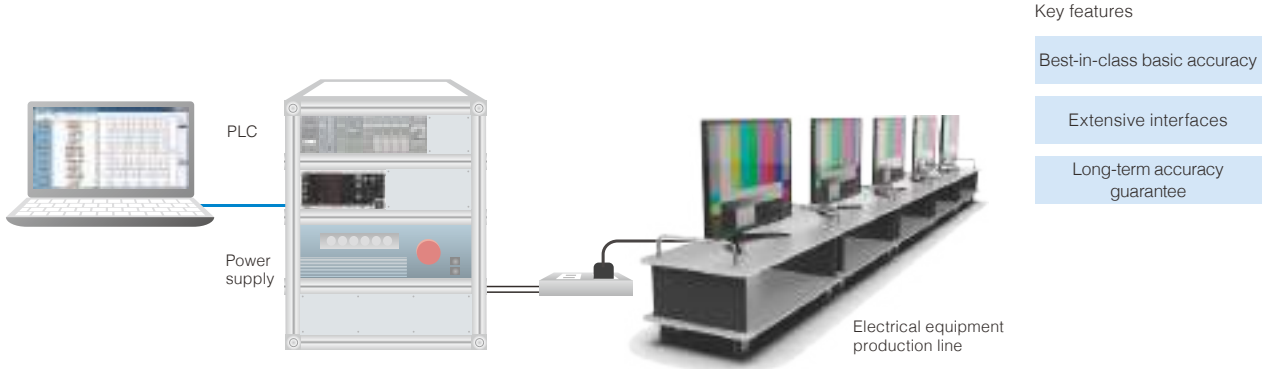

Best-in-class Accuracy $\pm 0.1\%$ * PW333 7 PW333 6 PW333 5

Our lineup provides reliable accuracy for a variety of measurement scenarios. Accurately measure the power consumption of a variety of household appliances, such as liquid crystal displays, refrigerators, and air conditioners.



Basic accuracy, AC
 $\pm 0.1\%$ *

* For complete details, please refer to the specifications

Accuracy Guaranteed Up to 3 Years (Longest in the Industry) 333 4 333 3

The 3333 and 3334 are guaranteed for accuracy for 3 years. Even after 3 years, they maintain an accuracy of $\pm 0.5\%$ rdg. as required for measurements. This 3-year accuracy guarantee, the longest in the industry, helps to save on calibration expenses.



3 years



Extensive Interfaces

PW333 7 PW333 6 PW333 5
333 4 333 3

The built-in interfaces are convenient for transferring data to a PC and equipping the unit on automated machines. PC communication software can be downloaded free of charge from the HIOKI website. For details about the built-in interfaces, refer to the specifications for each model.



Replacement for Analog Meters

PW333 7 PW333 6 PW333 5
333 4 333 3

These models can be used as replacements for analog voltmeters, ammeters, and watt meters. Up to 4 parameters such as voltage, current, and power can be displayed at the same time, allowing 3 measuring devices to be covered with a single unit. The digital display avoids issues such as parallax due to viewing angle and zero shift of the indicator.

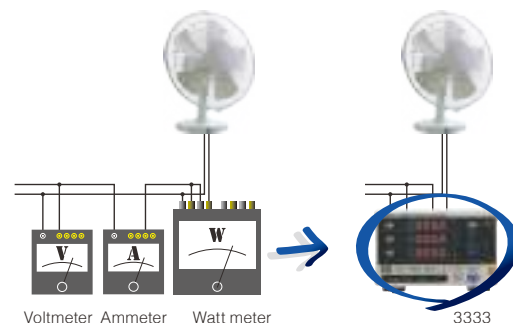

Standby Power Measurement

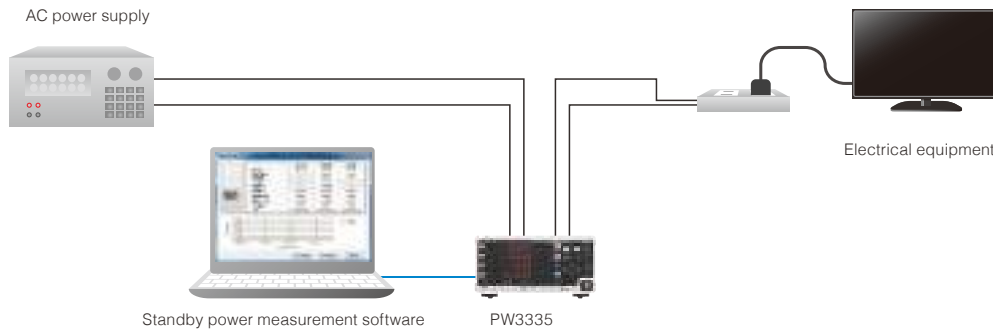

Key features

- Compliant with standby power standards
- Wide dynamic range
- Standby power measurement software



AC adapter standby power measurement, for primary AC and secondary DC

Compliant with IEC62301 and EN50564 Standards

The PW3335 is compliant with measurement standards for standby power, as well as other measurement standards including the ErP Directive and Energy Star. Special parameters required by such standards including THD, CF, and MCR can also be checked with this unit.

Requirements for Measurement Instruments for Standby Power Measurements (excerpt)

Requirement	PW3335 Performance
Power resolution of 1 mW or better	✓ Minimum resolution of 0.01 mW (in the 300 V/1 mA range)
Crest factor 3 support	✓ Crest factor 6 support
Harmonic component measurement of up to at least 50th order	✓ Harmonic measurement as standard feature
Data acquisition via interface	✓ LAN (standard feature), RS-232C, GP-IB

THD (Total Harmonic Distortion): Indicates to what extent harmonic components are present in an AC waveform
 CF (Crest Factor): Ratio of the peak value to the effective (RMS) value of an AC waveform
 MCR (Maximum Current Ratio): Current evaluation index, calculated from the crest factor and power factor

Create Reports with Free Software

Standby power measurement software can be downloaded free of charge from the HIOKI website. Enter the required information to perform standby power measurements according to standards. Use this software to create reports of measurement results and save test data in CSV format.

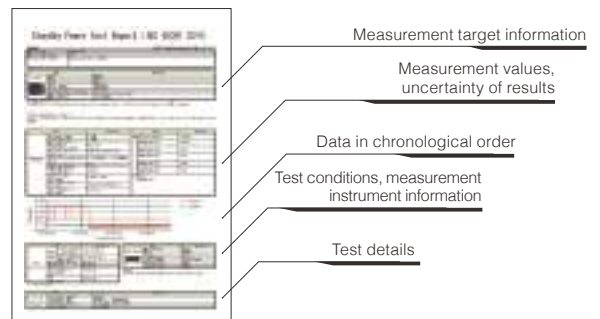

Example of Report Output

Wide Range of Effective Measurement

The PW3335 has an effective measurement range of 1% to 150%. Due to this wide range of effective measurement, even equipment with large load fluctuations, such as refrigerators, heaters, and pumps, can be measured accurately under all conditions from no-load to full operation.

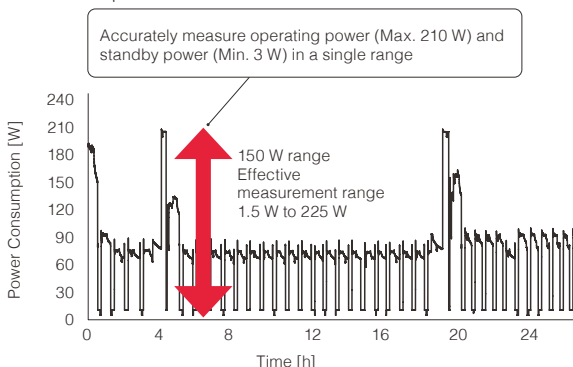

Long-term Measurement of Refrigerator Power

Support for CF6 (Crest Factor 6)

When an AC adapter or switching power supply operates with no load, the crest factor of the current waveform increases. The PW3335 can measure waveforms that exceed the range of watt meters that support crest factor 3.

In addition, although the power factor is low during no-load operation, the PW3335 is affected very little by power factor and can therefore achieve accurate measurements.

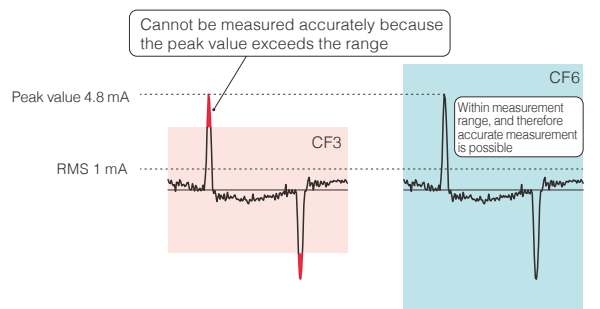

Example of Standby Current Waveform (CF = Peak Value, RMS = 4.8)

Measurement of Fluctuating Loads and Power Supply Control

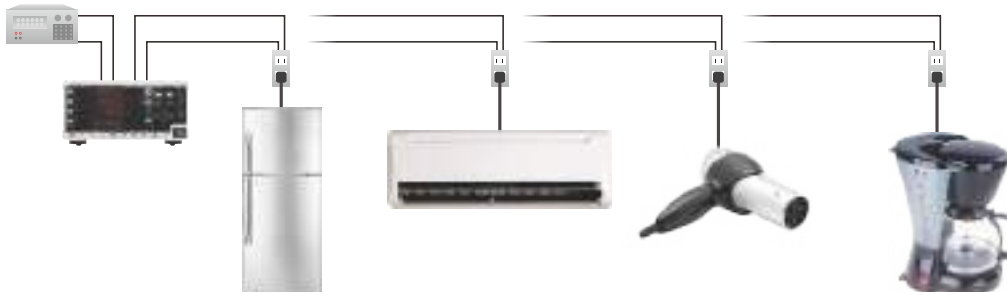

Key features

- Auto range integration
- Time average active power
- AC/DC power measurement

Auto Range Integration with Guaranteed Accuracy when Switching Ranges



These models automatically jump to the optimal power range according to current consumption when performing integration measurements. When switching ranges, power is integrated using the B range*, and therefore there is no loss of integration data. Achieve seamless power integration with guaranteed accuracy, even with loads that experience frequent and repeated fluctuations. In addition, since power integration can be performed for individual ranges, you can measure integrated power for the various conditions of devices that experience power fluctuations.

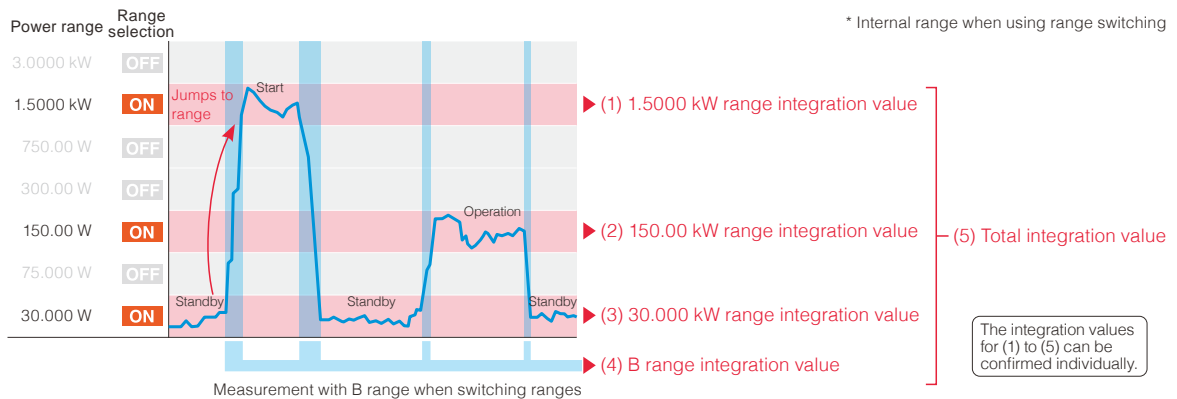

Intermittent Power Supply



Devices that perform intermittent operation and cycle control repeat a cycle of stopped states and operating states. Therefore, with normal power measurement, it is not possible to determine a value for rated power consumption.

Time average active power (current) is a function that allows the measurement of the time average for power (current) that experiences fluctuations.

$$\text{Time average power} = \text{Integration power} / \text{Integration time}$$

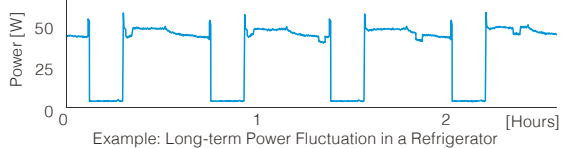

$$\text{Time average current} = \text{Integration current} / \text{Integration time}$$

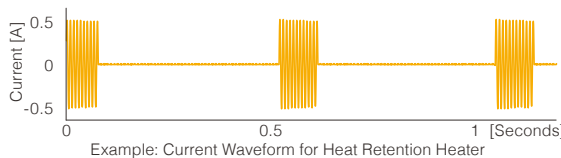

AC/DC Measurement



For equipment that uses rectifiers and control devices, it might not be possible to accurately measure voltage or current without an AC/DC power meter.

- Half-wave rectified waveforms used for dryers and fans
- Full-wave rectified waveforms used for AC adapters
- Cycle control waveforms used for voltage and temperature adjustment heaters
- DC waveforms with superimposed ripple components

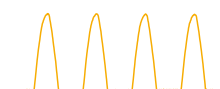

Half-wave Rectified Waveform

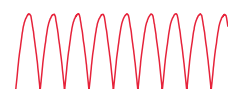

Full-wave Rectified Waveform

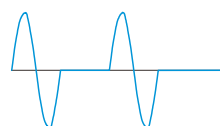

Cycle Control Waveform

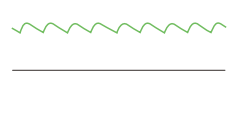

DC Waveform with Superimposed Ripple

Research, Development, and Inspection of Three-Phase Equipment

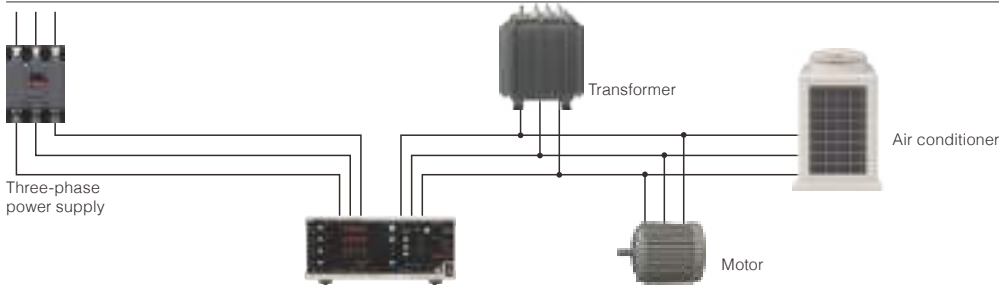

Key features

- Extensive connection settings
- Max. 65 A direct input
- Harmonic measurement function
- Current sensor input

Compliant with IEC61000-4-7 Harmonic Measurement Standards

These models are compliant with the IEC61000-4-7 international standard for harmonic measurements. Conduct harmonic analysis up to the 50th order. The upper limit for harmonic analysis can be set from 2nd to 50th, according to the standard used.

IEC61000-4-7 is an international standard for the measurement of harmonic current and harmonic voltage in power supply systems, and the harmonic current emitted from devices. It specifies the performance of standard measurement instruments. Among the series of standards that include specifications for power measurements, it is used as a reference standard for harmonic measurements.

Accuracy Guaranteed for Currents Up to 65 A

Because DCCT allows a current with an input resistance of 1 mΩ or less, accuracy is guaranteed up to 65 A. No heat is generated even with the input of large currents, so there is no loss of accuracy due to self heating. Even if the current exceeds 65 A, an optional current sensor allows measurements up to 5000 A.



DCCT current sensor (in the PW3337)

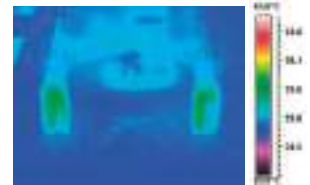

Temperature distribution image at 30 A DC/10-minute input

Support for Various Connections

The PW3337 supports not only 3V3A, but also a variety of three-phase connections such as 3P4W, 3P3W2M, and 3P3W3M.

Inverter Efficiency Measurement

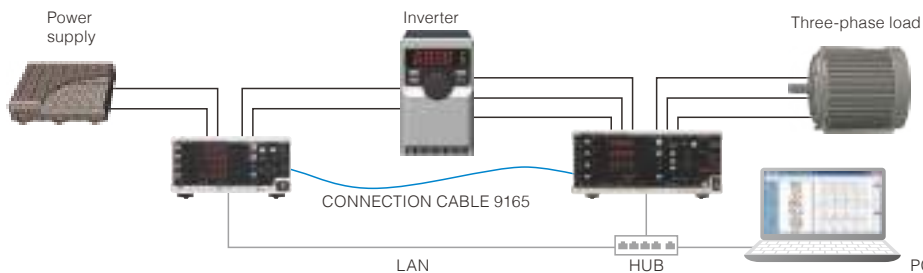

Key features

- Max. 24-channel power meter
- Wideband DC, 0.1 Hz to 100 kHz
- PW Communicator

Wide Frequency Band (DC, 0.1 Hz to 100 kHz)

These models cover not only the fundamental frequency bands for inverters, but also carrier frequency bands, in a wide range that includes DC and frequencies from 0.1 Hz to 100 kHz.

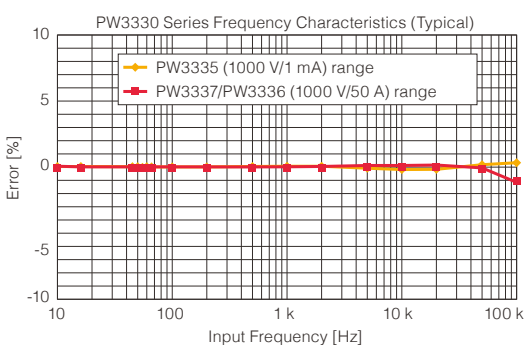

24-channel Power Meter with Synchronous Control for up to 8 Units

Connect 8 units for synchronous measurement of up to 24 channels. The calculation and control timing for PW3337, PW3336, and PW3335 units that are set as secondaries are synchronized with the primary unit. Use this feature to measure the I/O efficiency of power supply devices, compare multiple pieces of equipment, or to perform simultaneous parallel testing of production lines. Use the free PW COMMUNICATOR* software to calculate the efficiency between multiple units and to acquire data simultaneously from multiple units.

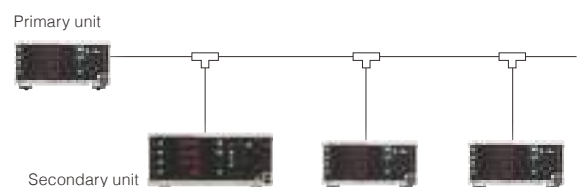

* This software can be downloaded from the HIOKI website.

PV Power Conditioner (PCS) Efficiency Measurements

DC - 3-phase/ DC 1-phase/
3-wire 2-wire

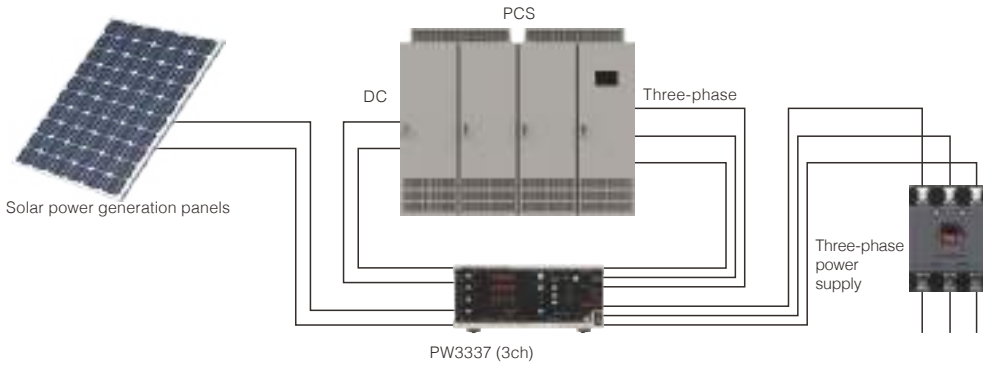

Key features

- Independent range per channel
- Extensive calculation functions
- Harmonic measurement function

Independent Ranges Per Channel for Highly Accurate Measurements

Independent channels allow the selection of the optimal range for each connection. One example is the simultaneous measurement of the primary side (DC) and secondary side (three-phase) of a PCS using a single unit. Selecting the optimal range for each target to be measured enables highly accurate measurements.

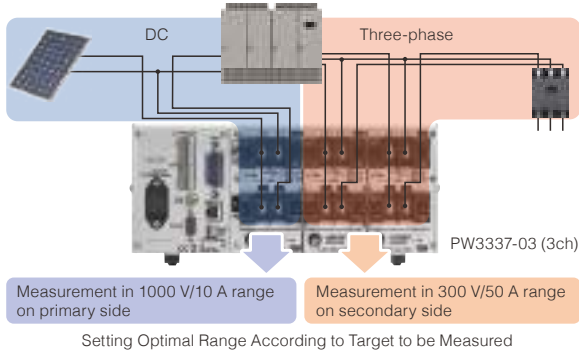

I/O Efficiency Calculation with a Single Unit

Input and output can be measured independently at the optimal ranges, and the PCS efficiency can be calculated and displayed on a single unit. PCS can be evaluated with a simple system configuration.

1000 V Range for Evaluation of Large Power Conditioners

These models support the measurement of large voltages, which is required in order to measure power conditioners for solar power generation. Measure up to 1000 Vrms and 1500 Vpeak.



Simultaneous Measurement of Power Data and Harmonics

In addition to standard measurement items such as voltage, current, and power, all items related to harmonics, such as distortion and content percentage, are calculated internally in parallel at the same time. Items such as RMS value, MEAN value, DC components, AC components, and fundamental wave components can all be confirmed simply by switching the display. Even for DC waveforms with superimposed ripple components, the AC/DC components can be measured separately. In addition, when using PC software, more than 180 measurement items can be acquired at the same time.

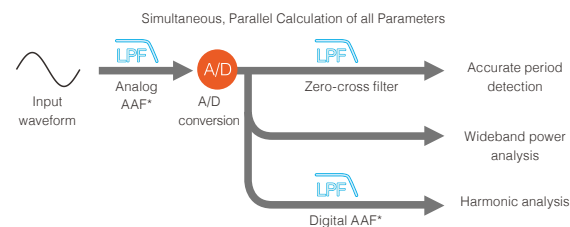

* AAF (Anti-aliasing filter): Filter that prevents aliasing errors during sampling

Aggregation of Output from DC Current Sensors (Up to 4000 A)

SENSOR UNIT CT9557 is a power supply for highly accurate current sensors that have a waveform output function. In addition to using it as a 4-channel power supply, it is also equipped with a sum feature for aggregating the input waveforms into a single waveform to be output.

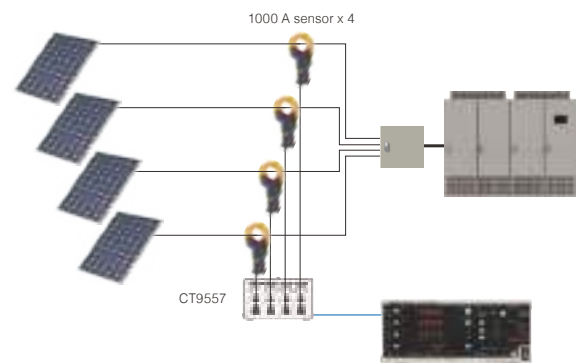

Aggregating the Output from 4 Sensors into One Unit

Output Function Linked with Recorder

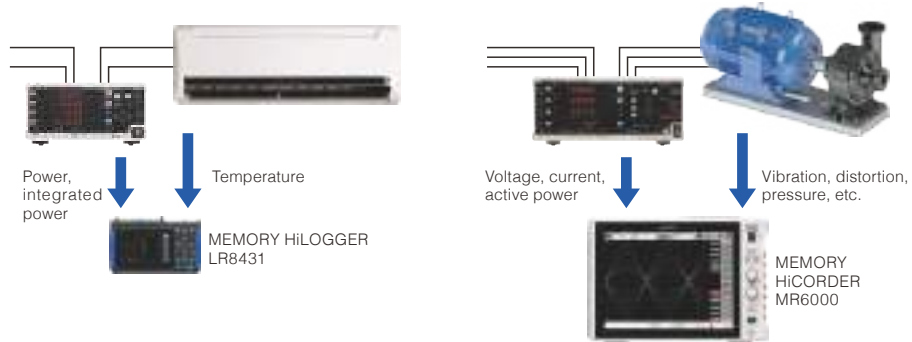

Key features

- Level output
- Waveform output
- High-speed level output
- LR8410Link

	PW3337-02 PW3337-03	PW3336-02 PW3336-03	PW3335-02 PW3335-04	3334 3334-01	3333 3333-01
Level output (Analog output)	Yes		Yes	Yes	Yes
Waveform output	Yes		Yes	Yes	-
High-speed level output	Active power only		Voltage, current, active power	-	-

Display Trends with a Data Logger



The level output (analog output) function delivers measured values that are displayed on the power meter with an analog voltage that is updated every 200 ms. Connect the unit to a data logger to check trends through synchronization with data such as temperature and heat flow*.

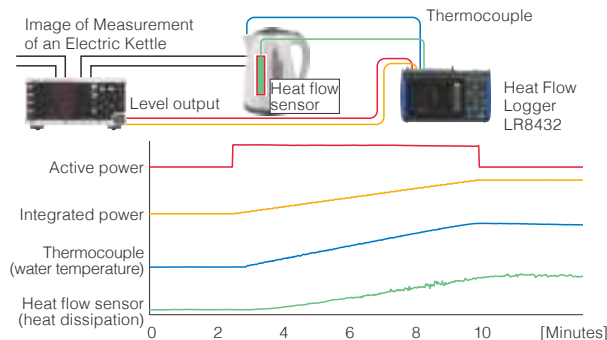

* Heat flow: Parameter for understanding the heat reception and heat dissipation of an object. Can be measured with a heat flow sensor.

Observe Waveforms with a Memory Hicorder



The waveform output function outputs the voltage/current waveforms captured by a power meter in the form of high-speed analog voltage. Connect to a memory recorder to check behavior when load fluctuates, such as with the inrush current of a motor.

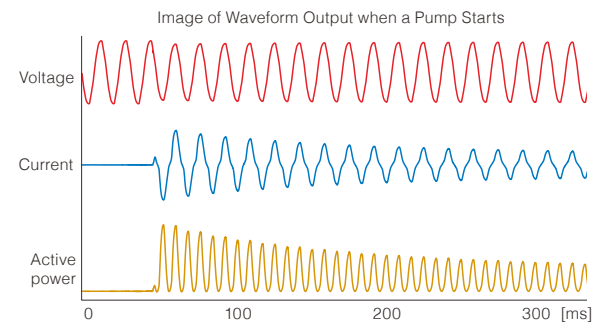

Observe Power for Each Cycle



The PW3337, PW3336, and PW3335 feature built-in, high-speed active power level output. Level is output for power per cycle. When used in combination with a memory hicorder, fluctuations in power can be observed in real time. This feature is also useful for analyzing equipment that uses power, such as monitoring cutting and grinding tools.

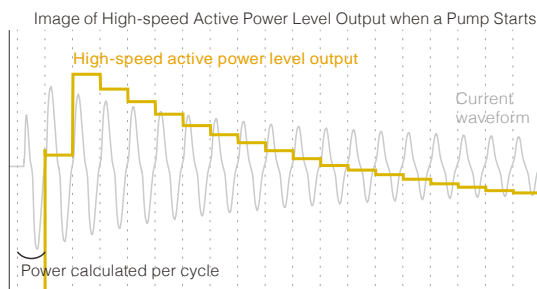

* With the PW3335, high-speed level output is also possible for 45 Hz to 66 Hz voltage and current.

Log Data Measured by a Power Meter Wirelessly on a Hioki Logger(LR8410 Link)



Wirelessly transmit measurement parameters from the Power Meter PW3335 (excluding model -01) to a Wireless Logging Station LR8410 via Bluetooth® wireless technology*.

- The PW3335-02 and PW3335-04 can transmit 7 D/A output parameters.
- The PW3335, PW3335-03 can transmit 4 parameters: voltage, current, power and power factor.

This allows you to combine the voltage and temperature data from the Logger with the current and power from the Power Meter in real time.

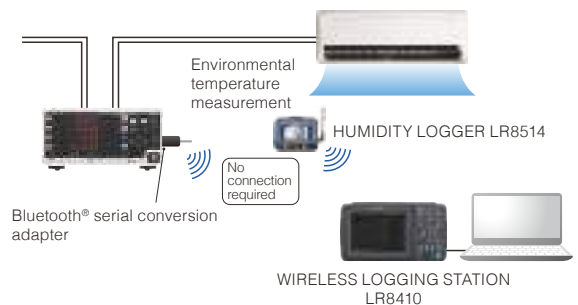

* Connection requires the serial - Bluetooth® wireless technology conversion adapter recommended by Hioki. Please inquire with your Hioki distributor.

No-load Loss Measurements for Transformers

Single-phase only

PW333 **7** PW333 **6** PW333 **5**

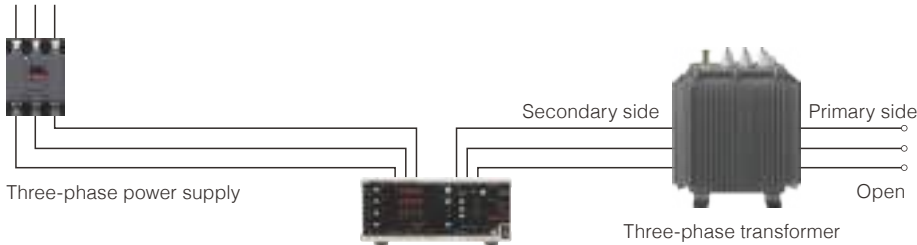

Key features

- Power factor effect $\pm 0.1\%$ f.s. or less
- Crest factor 6

Power Factor Effect of 0.1% or Less, Even at Low Power Factors

A no-load loss test is one indicator for evaluating energy conservation for transformers and motors. The PW3337 and PW3336 are affected very little by power factor, at $\pm 0.1\%$ f.s. or less, allowing active power to be measured with a high level of accuracy at low power factors.

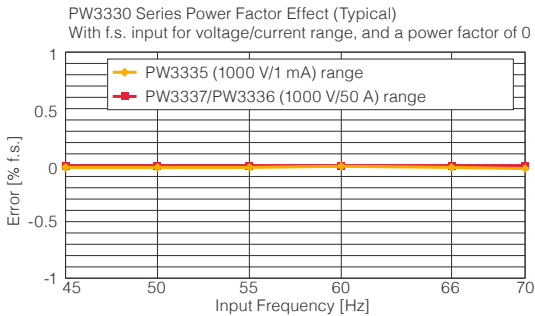

Support for Crest Factor 6

The crest factor of a current waveform increases during no-load operation. The PW3337, PW3336, and PW3335 support a crest factor 6. Therefore, even if the waveform peak value is large relative to the range, accurate measurements are possible without exceeding the range.

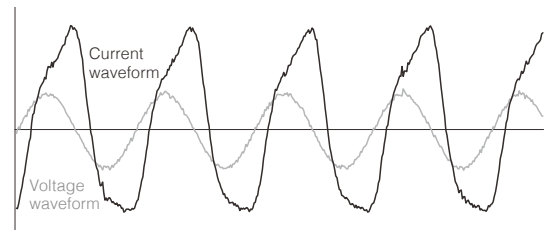

Example of Transformer Current Waveform during No-load Operation

DC Power Measurement for Batteries and Power Supplies

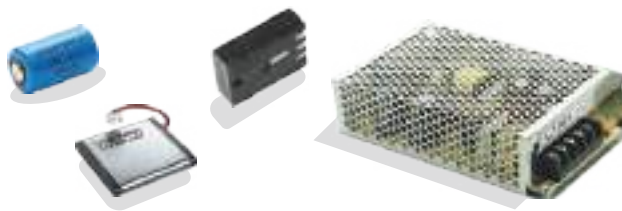

Key features

- DC power accuracy $\pm 0.2\%$ rdg.
- Power integration function by polarity

Best-in-class DC Power Accuracy

PW333 **7** PW333 **6**
PW333 **5**

These models are best for measuring battery power consumption and output from switching power supplies. Make accurate measurements of DC power, which is an important factor in improving efficiency and saving energy.



PW3337/PW3336



PW3335

DC power accuracy
 $\pm 0.1\%$ *

* For complete details, please refer to the specifications

Current and Power Integration Function by Polarity

PW333 **7** PW333 **6**
PW333 **5** 333 **4**

For integrated measurements, recharging power and discharging power are integrated by polarity every 200 ms. The amount of power in the positive direction, the amount of power in the negative direction, and the sum of the amounts of power in the positive and negative direction during the integration period are measured. Accurate measurement of recharging power and discharging power is possible even if there is rapid repetition of battery recharging/discharging.

Example of DC Power Fluctuation

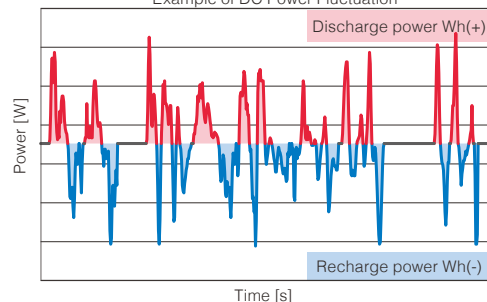

Options

TYPE 1 Current Sensor (General Current Measurements)



Connect this unit to the current sensor input terminal (BNC) on the PW3337/PW3336/PW3335. It can be used with a direct connection.

Wiring method	External appearance	Product name/ model no.	Rated current	Frequency band	Diameter of measurable conductors	Basic accuracy (amplitude) Basic accuracy (phase)	Cord lengths	Power supply
Clamp method		CLAMP ON SENSOR 9660	100 A	40 Hz to 5 kHz	φ 15 mm (0.59 in)	±0.3% rdg. ±0.02% f.s. Within ±1°	3 m (9.84 ft)	Not used
		CLAMP ON SENSOR 9661	500 A	40 Hz to 5 kHz	φ 46 mm (1.81 in)	±0.3% rdg. ±0.01% f.s. Within ±0.5°		
		CLAMP ON SENSOR 9669	1000 A	40 Hz to 5 kHz	φ 55 mm (2.17 in), 80 mm (3.15 in) × 20 mm (0.79 in) BUS BAR	±1.0% rdg. ±0.01% f.s. Within ±1°		
		FLEXIBLE CLAMP ON SENSOR CT9667-01	500 A/ 5000 A	10 Hz to 20 kHz	φ 100 mm (3.94 in)	±2.0% rdg. ±0.3% f.s. Within ±1°	AA (LR6) Alkaline Batteries x 2 (approx. 7 days) or AC ADAPTER 9445-02 (optional)	
		FLEXIBLE CLAMP ON SENSOR CT9667-02			φ 180 mm (7.09 in)			
		FLEXIBLE CLAMP ON SENSOR CT9667-03			φ 254 mm (10.00 in)			

Options for CT9667-01/-02/-03

External appearance	Product name/ model no.	Functions	Power supply
	AC ADAPTER 9445-02	For supplying power to CT9667-01/-02/-03	100 to 240 V AC

TYPE 2 Current Sensor (Highly Accurate Current Measurements)



Connect this unit to the current sensor input terminal (BNC) on the PW3337/PW3336/PW3335.
SENSOR UNIT CT9555 or CT9557 and CONNECTION CABLE L9217 are required.

Wiring method	External appearance	Product name/ model no.	Cord lengths	Rated current	Frequency band	Diameter of measurable conductors	Basic accuracy (amplitude)	Power supply		
Through method		CT6862-05	3 m (9.84 ft)	50 A	DC to 1 MHz	φ 24 mm (0.94 in)	±0.05% rdg. ±0.01 % f.s.	CT9555 or CT9557		
	NEW	CT6872	3 m (9.84 ft)		DC to 10 MHz	φ 24 mm (0.94 in)	±0.03% rdg. ±0.007 % f.s.			
		CT6872-01	10 m (32.81 ft)							
		CT6863-05	3 m (9.84 ft)	200 A	DC to 500 kHz	φ 24 mm (0.94 in)	±0.05% rdg. ±0.01 % f.s.			
	NEW	CT6873	3 m (9.84 ft)		DC to 10 MHz	φ 24 mm (0.94 in)	±0.03% rdg. ±0.007 % f.s.			
		CT6873-01	10 m (32.81 ft)							
	NEW	CT6875A	3 m (9.84 ft)	500 A	DC to 2 MHz	φ 36 mm (1.42 in)	±0.04% rdg. ±0.008 % f.s.			
		CT6875A-1	10 m (32.81 ft)		DC to 1.5 MHz					
	NEW	CT6876A	3 m (9.84 ft)	1000 A	DC to 1.5 MHz	φ 36 mm (1.42 in)				
		CT6876A-1	10 m (32.81 ft)		DC to 1.2 MHz					
	NEW	CT6877A	3 m (9.84 ft)	2000 A	DC to 1 MHz	φ 80 mm (3.15 in)				
		CT6877A-1	10 m (32.81 ft)							
	Clamp method	NEW	CT6841A	3 m (9.84 ft)	20 A	DC to 2 MHz			φ 20 mm (0.79 in)	±0.2% rdg. ±0.01% f.s.
		NEW	CT6843A	3 m (9.84 ft)	200 A	DC to 700 kHz			φ 20 mm (0.79 in)	
NEW		CT6844A	3 m (9.84 ft)	500 A	DC to 500 kHz	φ 20 mm (0.79 in)				
NEW		CT6845A	3 m (9.84 ft)	500 A	DC to 200 kHz	φ 50 mm (1.97 in)				
NEW		CT6846A	3 m (9.84 ft)	1000 A	DC to 100 kHz	φ 50 mm (1.97 in)				
		9272-05	3 m (9.84 ft)	20 A/ 200 A	1 Hz to 100 kHz	φ 46 mm (1.81 in)		±0.3% rdg. ±0.01% f.s.		

Options for Current Sensor TYPE 2

External appearance	Product name/ model no.	Max. no. of sensors	Functions	Power supply	Cord lengths
	SENSOR UNIT CT9555	1	For supplying power to the TYPE 2 current sensor	100 V to 240 V AC	-
	SENSOR UNIT CT9557	4	For supplying power to the TYPE 2 current sensor With addition output function	100 V to 240 V AC	-
	CONNECTION CORD L9217	-	For connecting CT9555/CT9557 and PW3330 series units	-	1.6 m (5.25 ft)

Connection Image

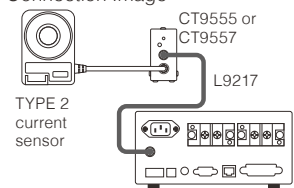

Rack Mount Hardware

HIOKI can also manufacture rack mount hardware (EIA, JIS).

Please contact your Hioki distributor or subsidiary for more information.

Software

PW Communicator



PW Communicator is an application for communicating between a PW3337/PW3336/PW3335 and a PC. This software can be downloaded free of charge from the HIOKI website. Use this software to configure the power meter, acquire interval data with a PC, perform numerical calculations for measurement data, calculate efficiency between multiple units, display 10 or more measurement items, and display waveforms.

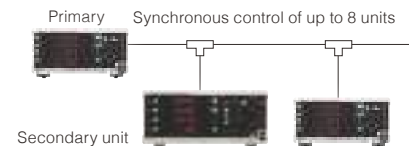
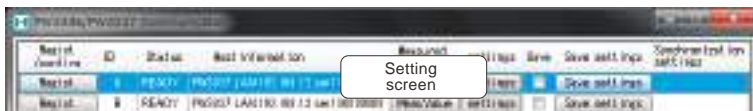
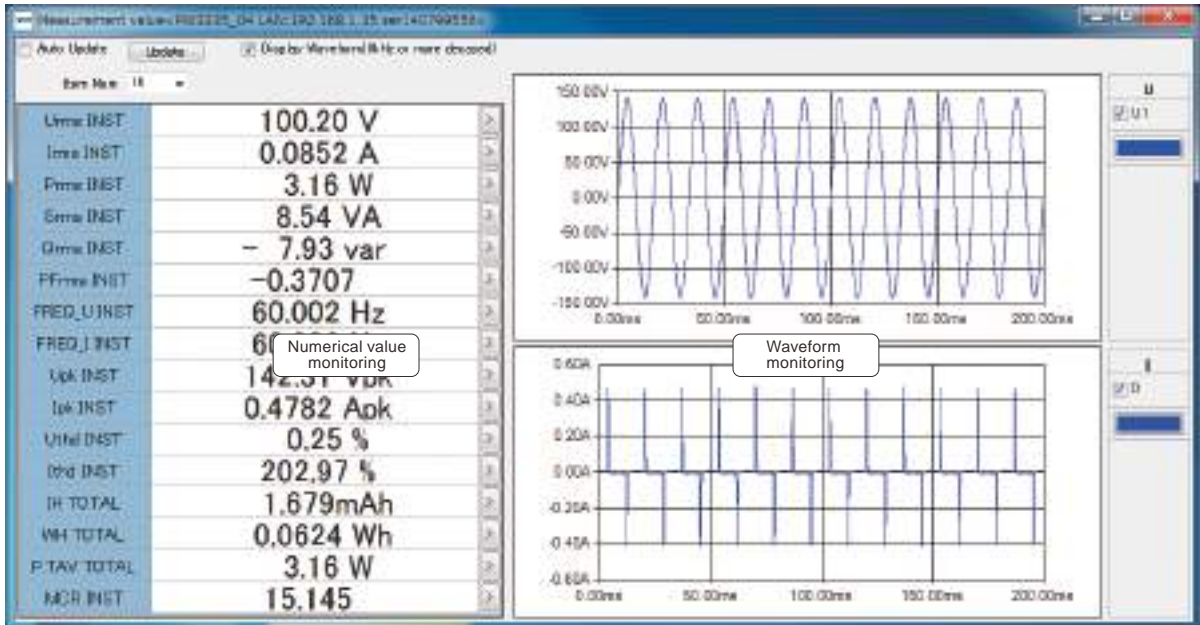

GENNECT One SF4000



Simultaneous measurements in combination with different measuring instruments (e.g., Memory HiLOGGER LR8450 and Power Meter PW3337) are possible. A single PC can be connected to up to 30 measuring instruments via Ethernet, enabling real-time batch display and recording of measurement data, as well as centralized data management.

Power **Temperature** **Strain**

GENNECT One

Functions

- Logging
- Dashboard
- Remote control

Special WEB site

Scan this QR Code for more information about GENNECT One.

LabVIEW Driver



Obtain data and configure measurement systems with the LabVIEW driver. (LabVIEW is a registered trademark of NATIONAL INSTRUMENTS.)

Sample Software



Sample software for loading data (via RS-232C) can be downloaded from the HIOKI website.

- The 3333/3334 front panel is displayed on the PC screen. Operate the power meter or change settings directly on the PC.
- The measured values for the 3333/3334 are displayed in real time on the PC screen. Save data as a CSV file.

Standby Power Measurement Software



"Standby Power Measurement Software" is an application software exclusively designed for the Power Meter PW3335. This software lets you to view PW3335 measurement data and also save them as reports or in CSV format via a LAN, GP-IB, or RS-232C. Measure standby power consumption in accordance with IEC62301. Download the software free of charge from the HIOKI website.

Workflow for Standby Power Test

1. Connect to power meter

Configure the settings for communication with a power meter. Connect the PC to a power meter, and enter the settings required for the interface used (LAN/RS-232C/GP-IB).



2. Configure the test target

Enter the information of the device under test. The information to be entered includes manufacturer name, model name, serial number, and operation mode. You can also register an image of the test target.



3. Configure the test power supply

Enter the information of the test power supply. Information to be entered includes rating and frequency. Also, enter the values of uncertainty due to the connection method, wiring, power supply, and temperature.

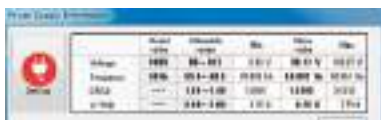

4. Configure the test conditions

Set the current range, stop conditions, algorithm used to judge stability, cycle time, and upper limit for test time.



5. Run test

The consumed power is measured according to the configured settings.



6. Create report

Create a report of the test results. Output either a PDF report or CSV file.

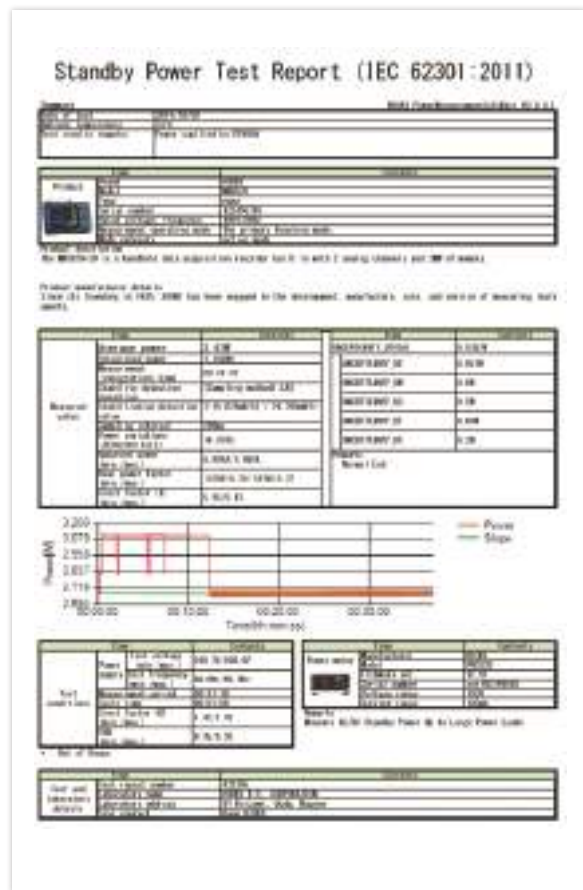

Example of report output

Model	PW3335					
Serial Number	ser140799556					
Firmware Ver	V0.07					
Start Time	2014	7	28	14	32	
Voltage Range	150V					
Current Range	200mA					
Update Rate	200ms					
Algorithm	LR	CA	SP1	SP2	SAF	
Stop Factor	Pee[Constant(LR)]					
Valid Period	0					
Time(Rec)	Test voltage(V)	Test frequency(Hz)	U-THD(%)	Crest Factor U	Crest Factor I	
14.8	99.49	60.002	0.26	1.4202	5.6212	
15	99.49	60.002	0.27	1.4199	5.6585	
15.2	99.49	60.002	0.25	1.4198	5.6896	
15.4	99.49	60.002	0.26	1.4198	5.6831	
15.6	99.49	60.002	0.26	1.4198	5.6652	
15.8	99.49	60.002	0.26	1.4198	5.6668	
1.6	99.49	60.002	0.26	1.4198	5.6484	
16.2	99.49	60.002	0.26	1.4198	5.6675	

CSV output example



PW3337 and PW3336 Specifications

Input Specifications

Measurement line type	PW3336 series Single-phase 2-wire (1P2W), Single-phase 3-wire (1P3W), Three-phase 3-wire (3P3W, 3P3W2M)			
	Wiring	CH1	CH2	
	1P2Wx2	1P2W	1P2W	
	1P3W		1P3W	
	3P3W		3P3W	
	3P3W2M		3P3W2M	
	PW3337 series Single-phase 2-wire (1P2W), Single-phase 3-wire (1P3W), Three-phase 3-wire (3P3W, 3P3W2M, 3V3A, 3P3W3M), Three-phase 4-wire (3P4W)			
	Wiring	CH1	CH2	CH3
	1P2Wx3	1P2W	1P2W	1P2W
	1P3W&1P2W		1P3W	1P2W
	3P3W&1P2W		3P3W	1P2W
	3P3W2M		3P3W2M	
	3V3A		3V3A	
	3P3W3M		3P3W3M	
	3P4W		3P4W	
Input methods	Voltage Isolated input, resistance voltage division method Current Isolated input, DCCCT method Isolated input from current sensors			
Voltage measurement ranges	AUTO/ 15.000 V/ 30.000 V/ 60.000 V/ 150.00 V/ 300.00 V/ 600.00 V/ 1000.0 V (set for each wiring mode)			
Current measurement ranges	AUTO/ 200.00 mA/ 500.00 mA/ 1.0000 A/ 2.0000 A/ 5.0000 A/ 10.000 A/ 20.000 A/ 50.000 A (set for each wiring mode) For more information about external current sensor input, see the external current sensor input specifications			
Power ranges	Depends on the combination of voltage and current ranges; PW3336: from 3.0000W to 100.00kW (also applies to VA, var) PW3337: from 3.0000W to 150.00kW (also applies to VA, var)			
Input resistance (50/60 Hz)	Voltage input terminal : 2 MΩ Current direct input terminal : 1 mΩ or less			

Basic Measurement Specifications

Measurement method	Simultaneous voltage and current digital sampling, zero-cross simultaneous calculation
Sampling frequency	Approx. 700 kHz
A/D converter	16-bit resolution
Frequency bands	DC, 0.1 Hz to 100 kHz
Synchronization sources	U1, U2, U3, I1, I2, I3, DC (fixed at 200 ms) Can be set separately for each wiring mode.
Measurement items	<ul style="list-style-type: none"> Voltage : Current : Active power : Apparent power Reactive power : Power factor : Phase angle : Frequency Efficiency : Current integration Active power integration : Integrated time Voltage waveform peak value : Current waveform peak value Voltage crest factor : Current crest factor Time average current : Time average active power Voltage ripple factor : Current ripple factor <p>Harmonic parameters:</p> <ul style="list-style-type: none"> Harmonic voltage RMS value : Harmonic current RMS value Harmonic active power : Total harmonic voltage distortion Total harmonic current distortion : Voltage fundamental waveform Current fundamental waveform : Active power fundamental waveform Apparent power fundamental waveform : Reactive power fundamental waveform Power factor fundamental waveform (displacement power factor) Voltage current phase difference fundamental waveform Interchannel voltage fundamental wave phase difference Interchannel current fundamental wave phase difference Harmonic voltage content % : Harmonic current content % Harmonic active power content % <p>The following parameters can be downloaded as data during PC communication but not displayed:</p> <ul style="list-style-type: none"> Harmonic voltage phase angle Harmonic current phase angle Harmonic voltage current phase difference

Rectifiers	<p>AC+DC: AC+DC measurement Display of true RMS values for both voltage and current</p> <p>AC+DC Umn: AC+DC measurement Display of average value rectified RMS converted values for voltage and true RMS values for current</p> <p>DC: DC measurement Display of simple averages for both voltage and current Display of values calculated by (voltage DC value) × (current DC value) for active power</p> <p>AC: AC measurement Display of values calculated by for both voltage and current Display of values calculated by $\sqrt{(AC+DC \text{ value})^2 - (DC \text{ value})^2}$ for active power</p> <p>FND Extraction and display of the fundamental wave component from harmonic measurement</p>
------------	---

Zero-Crossing Filter	500 Hz/200 kHz 500 Hz: 0.1 Hz to 500 Hz, 200 kHz: 0.1 Hz to 200 kHz
----------------------	--

Measurement accuracy	Voltage			
Frequency (f)	Input < 50% f.s.	50% f.s. ≤ Input < 100% f.s.	100% f.s. ≤ Input	
DC	±0.1%rdg. ±0.1%f.s.	±0.1%rdg. ±0.1%f.s.	±0.2%rdg.	
0.1Hz ≤ f < 16Hz	±0.1%rdg. ±0.2%f.s.	±0.3%rdg.	±0.3%rdg.	
16Hz ≤ f < 45Hz	±0.1%rdg. ±0.1%f.s.	±0.2%rdg.	±0.2%rdg.	
45Hz ≤ f ≤ 66Hz	±0.1%rdg. ±0.05%f.s.	±0.15%rdg.	±0.15%rdg.	
66Hz < f ≤ 500Hz	±0.1%rdg. ±0.1%f.s.	±0.2%rdg.	±0.2%rdg.	
500Hz < f ≤ 1kHz	±0.1%rdg. ±0.2%f.s.	±0.3%rdg.	±0.3%rdg.	
1kHz < f ≤ 10kHz	±0.5%rdg. ±0.3%f.s.	±0.8%rdg.	±0.8%rdg.	
10kHz < f ≤ 100kHz	±2.1%rdg. ±0.3%f.s.	±2.4%rdg.	±2.4%rdg.	
Current (direct input)	Voltage			
Frequency (f)	Input < 50% f.s.	50% f.s. ≤ Input < 100% f.s.	100% f.s. ≤ Input	
DC	±0.1%rdg. ±0.1%f.s.	±0.1%rdg. ±0.1%f.s.	±0.2%rdg.	
0.1Hz ≤ f < 16Hz	±0.1%rdg. ±0.2%f.s.	±0.3%rdg.	±0.3%rdg.	
16Hz ≤ f < 45Hz	±0.1%rdg. ±0.1%f.s.	±0.2%rdg.	±0.2%rdg.	
45Hz ≤ f ≤ 66Hz	±0.1%rdg. ±0.05%f.s.	±0.15%rdg.	±0.15%rdg.	
66Hz < f ≤ 500Hz	±0.1%rdg. ±0.1%f.s.	±0.2%rdg.	±0.2%rdg.	
500Hz < f ≤ 1kHz	±0.1%rdg. ±0.2%f.s.	±0.3%rdg.	±0.3%rdg.	
1kHz < f ≤ 10kHz	±(0.03+0.07×F)%rdg. ±0.2%f.s.	±(0.23+0.07×F)%rdg.	±(0.23+0.07×F)%rdg.	
10kHz < f ≤ 100kHz	±(0.3+0.04×F)%rdg. ±0.3%f.s.	±(0.6+0.04×F)%rdg.	±(0.6+0.04×F)%rdg.	

Active power	Frequency (f)			
	Input < 50% f.s.	50% f.s. ≤ Input < 100% f.s.	100% f.s. ≤ Input	
DC	±0.1%rdg. ±0.1%f.s.	±0.1%rdg. ±0.1%f.s.	±0.2%rdg.	
0.1Hz ≤ f < 16Hz	±0.1%rdg. ±0.2%f.s.	±0.3%rdg.	±0.3%rdg.	
16Hz ≤ f < 45Hz	±0.1%rdg. ±0.1%f.s.	±0.2%rdg.	±0.2%rdg.	
45Hz ≤ f ≤ 66Hz	±0.1%rdg. ±0.05%f.s.	±0.15%rdg.	±0.15%rdg.	
66Hz < f ≤ 500Hz	±0.1%rdg. ±0.1%f.s.	±0.2%rdg.	±0.2%rdg.	
500Hz < f ≤ 1kHz	±0.1%rdg. ±0.2%f.s.	±0.3%rdg.	±0.3%rdg.	
1kHz < f ≤ 10kHz	±(0.03+0.07×F)%rdg. ±0.2%f.s.	±(0.23+0.07×F)%rdg.	±(0.23+0.07×F)%rdg.	
10kHz < f ≤ 50kHz	±(0.07×F)%rdg. ±0.3%f.s.	±(0.3+0.07×F)%rdg.	±(0.3+0.07×F)%rdg.	
50kHz < f ≤ 100kHz	±(0.6+0.07×F)%rdg. ±0.3%f.s.	±(0.9+0.07×F)%rdg.	±(0.9+0.07×F)%rdg.	

- Values for f.s. depend on measurement ranges.
- "F" in the tables refers to the frequency in kHz.
- Add ±1mA to DC measurement accuracy for current.
- Add (±1mA) × (voltage read value) to DC measurement accuracy for active power.
- When using the 200mA or 500mA range, add ±0.1% rdg. to current and active power for which 1kHz < f ≤ 10kHz.
- Values for voltage, current, and active power for which 0.1Hz ≤ f < 10Hz are for reference only.
- Values for voltage, current, and active power in excess of 220V or 20A for which 10Hz ≤ f < 16Hz are for reference only.
- Values for current and active power in excess of 20A for which 500Hz < f ≤ 50kHz are for reference only.
- Values for current and active power in excess of 15A for which 50kHz < f ≤ 100kHz are for reference only.
- Values for voltage and active power in excess of 750V for which 30kHz < f ≤ 100kHz are for reference only.

Guaranteed accuracy period	1 year
Maximum effective peak voltage	±600% of each voltage range However, for 300 V, 600 V, and 1000 V ranges, ±1500 Vpeak
Maximum effective peak current	±600% of each current range However, for 20 A range and 50 A range, ±100 Apeak
Conditions of guaranteed accuracy	Temperature and humidity: 23°C ±5°C, 80% RH or less Warm-up time: 30 minutes Input: Sine wave input, power factor of 1, terminal-to-ground voltage of 0V, after zero adjustment; within range in which the fundamental wave satisfies synchronization source conditions
Temperature characteristic	±0.03% f.s. per °C or less
Power factor effects	±0.1% f.s. or less (45 to 66 Hz, at power factor = 0) Internal circuitry voltage/current phase difference: ±0.0573°
Effect of common mode voltage	±0.02% f.s. or less (600 V, 50/60 Hz, applied between input terminals and enclosure)
Effect of external magnetic field interference	400 A/m, DC and 50/60 Hz magnetic field Voltage : ±1.5% f.s. or less Current : ±1.5% f.s. or ±10 mA, whichever is greater, or less Active power : ±3.0% f.s. or (voltage influence quantity) × (±10 mA), whichever is greater, or less
Magnetization effect	±10 mA equivalent or less (after inputting 100 A DC to the current direct input terminals)
Adjacent channel input effect	±10 mA equivalent or less (when inputting 50 A to adjacent channel)

Voltage/ Current/ Active Power Measurement Specifications

Measurement types	Rectifiers: AC+DC, DC, AC, FND, AC+DC Umn
Effective measuring range	<p>Voltage: 1% to 130% of range (However, up to ±1500 V peak value and 1000 V RMS value)</p> <p>Current: 1% to 130% of range</p> <p>Active power: 0% to 169% of the range (However, defined when the voltage and current fall within the effective measurement range.)</p>
Display range	Voltage/ Current: 0.5% to 140% of range (zero-suppression when less than 0.5%) Active power: 0% to 196% of the range (no zero-suppression)
Polarity	Voltage/ Current: Displayed when using DC rectifier Active power: +: Positive: Power consumption (no polarity display) -: Regenerated power

Voltage/ Current/ Active power channel and sum value calculation formulas

Wiring	X: U (Voltage) or I (Current)	P (Active power)
All channels	1P2W $X_{(i)}$	$P_{(i)}$
	1P3W 3P3W 3P3W2M	$X_{sum} = \frac{1}{2} (X_{(1)} + X_{(2)})$ $P_{sum} = (P_{(1)} + P_{(2)})$
Sum values	3V3A 3P3W3M 3P4W	$X_{sum} = \frac{1}{3} (X_{(1)} + X_{(2)} + X_{(3)})$ $P_{sum} = (P_{(1)} + P_{(2)} + P_{(3)})$

(i): Measurement channel

Voltage Waveform Peak Value / Current Waveform Peak Value Measurement Specifications

Measurement method	Measures the waveform's peak value (for both positive and negative polarity) based on sampled instantaneous voltage values.							
Sampling frequency	Approx. 700 kHz							
Voltage peak range	Voltage range							
	15V	30V	60V	150V	300V	600V	1000V	
	90.000V	180.00V	360.00V	900.00V	1,800.00V	3,600.00V	6,000.00V	
Current peak range	Current range							
	200mA	500mA	1A	2A	5A	10A	20A	50A
	1,200.00A	3,000.00A	6,000.00A	12,000.00A	30,000.00A	60,000.00A	120,000.00A	300,000.00A
Measurement accuracy	Same as the voltage or current measurement accuracy at DC and when 10 Hz ≤ f ≤ 1 kHz (f.s.: voltage peak range or current peak range). Provided as reference value when 0.1 Hz ≤ f < 10 Hz and when in excess of 1 kHz.							
Effective measuring range	±5% to ±100% of voltage peak range (up to ±1500 V) or ±5% to ±100% of current peak range (up to ±100 A)							
Display range	±0.3% to ±102% of voltage peak range or current peak range (values less than ±0.3% are subject to zero-suppression)							

Voltage Crest Factor/ Current Crest Factor Measurement Specifications

Measurement method	Calculates values from display values once each display update interval for voltage and voltage waveform peak values or current and current waveform peak values.
Effective measuring range	As per voltage and voltage waveform peak value or current and current waveform peak value effective measurement ranges.
Display range	1.0000 to 612.00 (no polarity)

Voltage Ripple Rate / Current Ripple Factor Measurement Specifications

Measurement method	Calculates the AC component (peak to peak [peak width]) as a proportion of the voltage or current DC component
Effective measuring range	As per voltage and voltage waveform peak value or current and current waveform peak value effective measurement ranges
Display range	0.00[%] to 500.00[%]
Polarity	None

Apparent Power/ Reactive Power/ Power Factor/ Phase Angle Measurement Specifications

Measurement types	Rectifiers Apparent Power/ Reactive Power/ Power Factor : AC+DC, AC, FND, AC+DC Umn Phase Angle : AC, FND
Effective measuring range	As per voltage, current, and active power effective measurement ranges.
Display range	Apparent Power/ Reactive Power : 0% to 196% of the range (no zero-suppression) Power Factor : ±0.0000 to ±1.0000 Phase Angle : +180.00 to -180.00
Polarity	Reactive Power/ Power Factor/ Phase Angle Polarity is assigned according to the lead/lag relationship of the voltage waveform rising edge and the current waveform rising edge. + : When current lags voltage (no polarity display) - : When current leads voltage

Power channel and sum value calculation formulas

Wiring	S : Apparent power	Q : Reactive power
All channels	$S_{(i)} = U_{(i)} \times I_{(i)}$	$Q_{(i)} = si(i) \sqrt{S_{(i)}^2 - P_{(i)}^2}$
Sum values	1P2W $S_{sum} = S_{(1)} + S_{(2)}$	$Q_{sum} = Q_{(1)} + Q_{(2)}$
	3P3W $S_{sum} = \sqrt{3} (S_{(1)} + S_{(2)})$	
	3P3W2M 3V3A $S_{sum} = \sqrt{3} (S_{(1)} + S_{(2)} + S_{(3)})$	
	3P3W3M 3P4W $S_{sum} = S_{(1)} + S_{(2)} + S_{(3)}$	

(i) : Measurement channel

Wiring	λ : Power factor	ϕ : Phase angle
All channels	$\lambda_{(i)} = si(i) \left \frac{P_{(i)}}{S_{(i)}} \right $	$\phi_{(i)} = si(i) \cos^{-1} \lambda_{(i)} $
Sum values	$\lambda_{sum} = S_{sum} \left \frac{P_{sum}}{S_{sum}} \right $	When $P_{sum} \geq 0$ $\phi_{sum} = S_{sum} \cos^{-1} \lambda_{sum} $ (0° to ±90°)
		When $P_{sum} < 0$ $\phi_{sum} = S_{sum} 180 - \cos^{-1} \lambda_{sum} $ (±90° to ±180°)

(i) : Measurement channel ; The polarity symbol sisum is acquired from the Qsum symbol.

Frequency Measurement Specifications

Number of measurement channels	3 ch
Measurement source	Select from U (VHz) or I (AHz) by channel
Measurement method	Calculated from input waveform period (reciprocal method)
Measurement range	500 Hz/ 200 kHz (linked to zero-cross filter)
Measurement accuracy	±0.1% rdg. ±1 dgt. (0°C to 40°C)
Effective measuring range	0.1 Hz to 100 kHz For sine wave input that is at least 20% of the measurement source's measurement range. Measurement lower limit frequency setting: 0.1 sec. / 1 sec. / 10 sec.
Display format	0.1000 Hz to 9.9999 Hz, 9.900 Hz to 99.999 Hz, 99.00 Hz to 999.99 Hz, 9900 kHz to 9.9999 kHz, 9.900 kHz to 99.999 kHz, 99.00 kHz to 220.00 kHz

Efficiency Measurement Specifications

Measurement method	Calculates the efficiency η [%] from the ratio of active power values for channels and wires	
Wiring modes and calculation equations	Calculated based on the AC+DC rectifier active power PW3336	
Wiring	CH1 CH2 Calculation formulas	
1P2W × 2	1P2W 1P2W	$\eta_1 = 100 \times P_2 / P_1 $ $\eta_2 = 100 \times P_1 / P_2 $
1P3W	1P3W	
3P3W	3P3W	
3P3W2M	3P3W2M	
PW3337	CH1 CH2 CH3 Calculation formulas	
1P2W × 3	1P2W 1P2W 1P2W	$\eta_1 = 100 \times P_3 / P_1 $ $\eta_2 = 100 \times P_1 / P_3 $
1P3W & 1P2W	1P3W 1P2W	$\eta_1 = 100 \times P_3 / P_{sum} $
3P3W & 1P2W	3P3W 1P2W	$\eta_2 = 100 \times P_{sum} / P_3 $
3P3W2M	3P3W2M	
3V3A	3V3A	
3P3W3M	3P3W3M	
3P4W	3P4W	
Effective measuring range	As per the active power effective measurement range.	
Display range	0.00[%] to 200.00[%]	

Time Average Current / Time Average Active Power Measurement Specifications (T.AV)

Measurement method	Calculates the average by dividing the integrated value by the integration time
Measurement accuracy	±(Current or active power measurement accuracy) ±(±0.01%rdg. ±1dgt.)
Effective measuring range	As per the current or active power effective measurement range

Functional Specifications

Auto-range (AUTO)	Automatically changes the voltage and current range for each wiring mode according to the input Range up: The range is increased when input exceeds 130% of the range or when the peak is exceeded. Range down: The range is decreased when input falls below 15% of the range. However, the range is not decreased when the peak is exceeded at the lower range.
Averaging (AVG)	· Averages the voltage, current, active power, apparent power, and reactive power. · The power factor and phase angle are calculated from averaged data. · Measured values other than peak values, power factor, frequency, integrated values, T.AV, crest factor, ripple rate, total harmonic distortion, and harmonics are averaged. Method : Simple averaging Number of averaging iterations and display update interval
Number of averaging iterations	1 (OFF) 2 5 10 25 50 100
Display update interval	200ms 400ms 1s 2s 5s 10s 20s

Scaling (VT, CT)	Applies user-defined VT and CT ratio settings to measured values. These settings can be configured separately for each wiring mode. VT ratio setting range : OFF (1.0), 0.1 to 1000 (setting: 0000) CT ratio setting range : OFF (1.0), 0.001 to 1000 (setting: 0000)
HOLD (HOLD)	· Stops display updates for all measured values and fixes the display values at that point in time. · Measurement data acquired by communications is also fixed at that point in time. · Internal calculations (including integration and integration elapsed time) will continue. · Analog output and waveform output are not held.
Maximum value/ minimum value hold (MAX/MIN HOLD)	· Detects maximum and minimum measured values as well as maximum and minimum values for the voltage and current waveform peak and holds them on the display. · For data with polarity, display of the maximum value and minimum value for the data's absolute values is held (so that both positive and negative polarity values are shown). · Internal calculations (including integration and integration elapsed time) will continue. · Analog output and waveform output are not held.
Zero Adjustment (0 ADJ)	Degausses the current input unit DCCT and then zeroes out the current input offset.
Key-lock (KEY LOCK)	Disables key input in the measurement state, except for the SHIFT key and KEY LOCK key.
Backup	Backs up settings and integration data if the instrument is turned off and if a power outage occurs.
System Reset	Initializes the instrument's settings. Communications-related settings (communications speed, address, and LAN-related settings) are not initialized.

Integration Measurement Specifications

Measurement items	Simultaneous integration of the following 6 parameters for each channel (total of 18 parameters): Sum of current integrated values (displayed as Ah on panel display) Positive current integrated value (displayed as Ah+ on panel display) Negative current integrated value (displayed as Ah- on panel display) Sum of active power integrated values (displayed as Wh on panel display) Positive active power integrated value (displayed as Wh+ on panel display) Negative active power integrated value (displayed as Wh- on panel display)
Measurement types	Rectifiers: AC+DC, AC+DC Umn Current: Displays the result of integrating current RMS value data (display values) once every display update interval (approx. 200 ms) as an integrated value. Active power: Displays the result of integrating active power values by polarity calculated once every cycle for the selected synchronization source as integrated values. Rectifier: DC Displays the result of integrating instantaneous data obtained by sampling both current and active power by polarity as integrated values (When the active power contains both AC and DC, the DC component will not be integrated)
Integration time	1 min. to 10000 hr., settable in 1 min. blocks
Integration time accuracy	±100 ppm ±1 dgt. (0°C to 40°C)
Integration measurement accuracy	(Current or active power measurement accuracy) + (±0.01% rdg. ±1 dgt.)
Effective measuring range	Until PEAK OVER U or PEAK OVER I occurs
Display resolution	999999 (6 digits + decimal point)
Functions	· Stopping integration based on integration time setting (timer) · Displaying the integration elapsed time (displayed as TIME on panel display) · Additional integration by repeatedly starting/stopping integration · Backing up integrated values and the integration elapsed time during power outages · Stopping integration when power returns
External control	Stopping/starting integration and resetting integrated values based on external control
Measuring range	Corresponds to the range set for START integration

Harmonic Measurement Specifications (built-in function)

Measurement method	· Zero-cross simultaneous calculation method (separate windows by channel according to the wiring mode) · Uniform thinning between zero-cross events after processing with a digital antialiasing filter · Interpolation calculations (Lagrange interpolation) · When the synchronization frequency falls within the 45 Hz to 66 Hz range » IEC 61000-4-7:2002 compliant » Gaps and overlaps may occur if the measurement frequency is not 50 Hz or 60 Hz · When the synchronization frequency falls outside the 45 Hz to 66 Hz range » No gaps or overlap will occur
Synchronization source	Conforms to synchronization source (SYNC) for the basic measurement specifications.
Measurement channels	3
Measurement items	· Harmonic voltage RMS value · Harmonic voltage content % · Harmonic voltage phase angle · Harmonic current RMS value · Harmonic current content % · Harmonic current phase angle · Harmonic active power · Harmonic active power content % · Harmonic voltage current phase difference · Total harmonic voltage distortion · Total harmonic current distortion · Voltage fundamental waveform · Current fundamental waveform · Active power fundamental waveform · Apparent power fundamental waveform · Reactive power fundamental waveform · Power factor fundamental waveform · Voltage current phase difference fundamental waveform · Interchannel voltage fundamental wave phase difference · Interchannel current fundamental wave phase difference
The following parameters can be downloaded as data during PC communication but not displayed: · Harmonic voltage phase angle · Harmonic current phase angle · Harmonic voltage current phase difference	
FFT processing word length	32 bits
Number of FFT points	4096
Window function	Rectangular
Analysis window width	45 Hz ≤ f < 56 Hz: 178.57 ms to 222.22 ms (10 cycles) 56 Hz ≤ f < 66 Hz: 181.82 ms to 214.29 ms (12 cycles) Frequencies other than the above: 185.92 ms to 214.08 ms
Data update rate	Depends on window width
Synchronization frequency range	10 Hz to 640 Hz
Maximum analysis order	Synchronization frequency (f) range Analysis order
	10 Hz ≤ f < 45 Hz 50th
	45 Hz ≤ f < 56 Hz 50th
	56 Hz ≤ f ≤ 66 Hz 50th
	66 Hz < f ≤ 100 Hz 50th
	100 Hz < f ≤ 200 Hz 40th
	200 Hz < f ≤ 300 Hz 25th
	300 Hz < f ≤ 500 Hz 15th
	500 Hz < f ≤ 640 Hz 11th



Analysis order upper limit setting	2nd to 50th	
Measurement accuracy	f.s.: Measurement range	
	Frequency (f)	Voltage, Current, Active power
	DC	±0.4%rdg, ±0.2%f.s.
	10 Hz ≤ f < 30 Hz	±0.4%rdg, ±0.2%f.s.
	30 Hz ≤ f < 400 Hz	±0.3%rdg, ±0.1%f.s.
	400 Hz < f ≤ 1 kHz	±0.4%rdg, ±0.2%f.s.
	1 kHz < f ≤ 5 kHz	±1.0%rdg, ±0.5%f.s.
	5 kHz < f ≤ 8 kHz	±4.0%rdg, ±1.0%f.s.
	For DC, add ±1 mA to current and (±1 mA) × (voltage read value) to active power.	

Display Specifications

Display	7-segment LED
Number of display parameters	4
Display resolution	Other than integrated values: 99999 count Integrated values: 999999 count
Display update rate	200 ms to 20 s (varies with number of averaging iterations setting)

Synchronized Control

Functions	Timing of calculations, display updates, data updates, integration start/stop/reset events, display hold operation, key lock operation, and zero-adjustment operation for the secondary PW3336/PW3337 are synchronized with the primary PW3336/PW3337.
Terminal	BNC terminal × 1 (non-isolated)
Terminal name	EXT SYNC
I/O settings	Off: Synchronized control function off In : The EXT SYNC terminal is set to input, and a dedicated synchronization signal can be input (secondary). Out: The EXT SYNC terminal is set to output, and a dedicated synchronization signal can be output (primary).
Number of units for which synchronized control can be performed	1 primary unit and 7 secondary units (total 8 units)

External Current Sensor Input Specifications (built-in feature)

Terminal	Isolated BNC terminals, 1 for each channel		
Current sensor type switching	Off / Type 1 / Type 2 When set to off, input from the external current sensor input terminal is ignored.		
Current sensor options	TYPE1 (100 A to 5000 A sensors) 9660, 9661, 9669, CT9667-01/-02/-03 TYPE2 (20 A to 2000 A sensors, Power supply is required to use) CT6862-05, CT6863-05, CT6872, CT6872-01, CT6873, CT6873-01, CT6875A, CT6875A-1, CT6876A, CT6876A-1, CT6877A, CT6877A-1, 9272-05, CT6841A, CT6843A, CT6844A, CT6845A, CT6846A		
Current measurement range	Auto / 10 A / 20 A / 50 A (range noted on panel) User-selectable for each wiring mode. Can be read directly by manually setting the CT ratio.		
Power range configuration	Depends on the combination of voltage and current ranges; from 60.000W to 15.000MW (also applies to VA, var)		
Measurement accuracy	Current, Active power		
	Frequency	Input < 50%f.s.	50%f.s. ≤ Input < 100%f.s.
	DC	±0.2%rdg, ±0.6%f.s.	±0.2%rdg, ±0.6%f.s.
	0.1Hz ≤ f < 16Hz	±0.2%rdg, ±0.2%f.s.	±0.4%rdg, ±0.4%rdg.
	16Hz ≤ f < 45Hz	±0.2%rdg, ±0.2%f.s.	±0.4%rdg, ±0.4%rdg.
	45Hz ≤ f < 66Hz	±0.2%rdg, ±0.1%f.s.	±0.3%rdg, ±0.3%rdg.
	66Hz ≤ f < 500Hz	±0.2%rdg, ±0.2%f.s.	±0.4%rdg, ±0.4%rdg.
	500Hz < f ≤ 1kHz	±0.2%rdg, ±0.3%f.s.	±0.5%rdg, ±0.5%rdg.
	1kHz < f ≤ 10kHz	±5.0%rdg.	±5.0%rdg.
	10kHz < f ≤ 50kHz		
	50kHz < f ≤ 100kHz		

f.s.: Each measurement range

- To obtain the current or active power accuracy, add the current sensor's accuracy to the above current and active power accuracy figures.
- The effective measurement range and frequency characteristics conform to the current sensor's specifications.
- Values for current, and active power for which 0.1 Hz ≤ f < 10 Hz are for reference only.
- Values for voltage in excess of 220 V active power for which 10 Hz ≤ f < 16 Hz are for reference only.

Temperature characteristics	Current, active power: ±0.08% f.s./°C (instrument temperature coefficient); f.s.: instrument measurement range) Add current sensor temperature coefficient to above.
Power factor effects	· Instrument: ±0.15% f.s. or less (45 Hz to 66 Hz with power factor = 0) · Internal circuit voltage/current phase difference: ±0.086° · Add the current sensor phase accuracy to the internal circuit voltage/current phase difference noted above.
Current peak value measurement accuracy	(External current sensor input instrument accuracy) + (±2.0% f.s.) (f.s.: current peak range) · Add the current sensor accuracy to the above.
Harmonic measurement accuracy	Frequency Voltage Current, Active power DC ±0.4%rdg, ±0.2%f.s. ±0.6%rdg, ±0.8%f.s. 10Hz ≤ f < 30Hz ±0.4%rdg, ±0.2%f.s. ±0.6%rdg, ±0.4%f.s. 30Hz ≤ f < 400Hz ±0.3%rdg, ±0.1%f.s. ±0.5%rdg, ±0.3%f.s. 400Hz < f ≤ 1kHz ±0.4%rdg, ±0.2%f.s. ±0.6%rdg, ±0.5%f.s. 1kHz < f ≤ 5kHz ±1.0%rdg, ±0.5%f.s. ±1.0%rdg, ±0.5%f.s. 5kHz < f ≤ 8kHz ±4.0%rdg, ±1.0%f.s. ±2.0%rdg, ±0.6%f.s.
	f.s.: Each measurement range · To obtain the current or active power accuracy, add the current sensor's accuracy to the above current and active power accuracy figures.

D/A Output Specifications (PW3336-02-03 and PW3337-02-03)

Number of output channels	16
Configuration	16-bit D/A converter (polarity + 15 bits)
Output parameters	U1 to U3 (voltage level) or u1 to u3 (instantaneous voltage waveform) (switchable) I1 to I3 (current level) or i1 to i3 (instantaneous current waveform) (switchable) P1 to P3 (active power level) or p1 to p3 (instantaneous power waveform) (switchable) Psum (active power level) or Hi-Psum (high-speed active power level) (switchable) Psum and Hi-Psum output is not available (0 V) when using the 1P2W wiring mode. P12 is output when using 1P3W, 3P3W, or 3P3W2M, and P123 is output when using 3V3A, 3P3W3M, or 3P4W. D/A1 to D/A3 · Select any 3 from channel or sum value for Voltage, Current, Active power, Apparent power, Reactive power, Power factor, Phase angle, Total harmonic voltage/current distortion, Inter-channel voltage/current fundamental wave phase difference, Voltage/current crest factor, Time average current/active power, Voltage/current ripple rate, Frequency, Efficiency, Current integration, Active power integration (Harmonic output is not available for individual orders). Hi-P1 to Hi-P3 and Hi-Psum (high-speed active power level): Fixed to AC+DC For other level output, select AC+DC, AC+DC Umn, DC, AC, or fnd.

Output accuracy	f.s.: Relative to the output voltage rated value for each output parameter Level output : (Output parameter measurement accuracy) + (±0.2% f.s.) High-speed active power level output : (Output parameter measurement accuracy) + (±0.2% f.s.) Instantaneous waveform output : (Output parameter measurement accuracy) + (±1.0% f.s.) Instantaneous voltage, instantaneous current: RMS value level Instantaneous power: Average value level
Output frequency band	Instantaneous waveform output, high-speed active power level output At DC or 10 Hz to 5 kHz, accuracy is as defined above.
Output voltage	Level output Voltage, Current, Active power, Apparent power, Reactive power, Time average current/active power : ±2 V DC for ±100% of range Power factor : ±2 V DC at ±0.0000, 0 V DC at ±1.0000 Phase angle : 0 V DC at 0.00°, ±2 V DC at ±180.00° Voltage/current ripple rate, total harmonic voltage/current distortion : ±2 V DC at 100.00% Voltage/current crest factor : ±2 V DC at 10.000 Frequency : Varies with measured value. +2 V DC per 100 Hz from 0.1000 Hz to 300.00 Hz +2 V DC per 10 kHz from 300.01 Hz to 30.000 kHz +2 V DC per 100 kHz from 30.001 kHz to 220.00 kHz Efficiency : ±2 V DC at 200.00% Current integration, active power integration : ±5 V DC at (range) × (integration set time) Waveform output : 1 V f.s. relative to 100% of range
Maximum output voltage	Approx. ±12 V DC
Output update rate	Level output : Fixed at 200 ms ±50 ms (approx. 5 times per sec.) Update rate is unrelated to number of averaging iterations setting and display hold operation. Waveform output : Approx. 11.4 μs (approx. 87.5 kHz) High-speed P level : Updated once every cycle for the input waveform set as the synchronization source.
Response time	Level output : 0.6 sec. or less (when the input changes abruptly from 0% to 90%, or from 100% to 10%, the time required in order to satisfy the accuracy range) Waveform output : 0.2 ms or less High-speed active power level output : 1 cycle
Temperature characteristic	±0.05% f.s./°C or less
Output resistance	100 Ω ±5 Ω

External control (built-in feature)

Functions	Integration start/stop, integration reset and hold via external control		
External control	Input signal level: 0 to 5 V (high-speed CMOS level or shorted [Lo]/open [Hi])		
	Functions	External control signal	External control terminal
	Start	Hi → Lo	START/STOP
	Stop	Lo → Hi	
	Reset	Lo interval of at least 200 ms	RESET
	Hold on	Hi → Lo	HOLD
	Hold off	Lo → Hi	

GP-IB interface (PW3336-01/-03, PW3337-01/-03)

Method	IEEE488.1 1978 compliant; see IEEE488.2 1987 Interface functions: SH1, AH1, T6, L4, SR1, RL1, PP0, DC1, DT1, C0 Remote control by controller
Address	00 to 30

RS-232C interface (built-in feature)

Connector	D-sub 9-pin connector × 1
Communication method	Full duplex, Start-stop synchronization, Stop bits: 1 (fixed), Data bits: 8 (fixed), Parity: None Remote control by controller
Communication Speed	9600bps / 38400bps

LAN interface (built-in feature)

Connector	RJ-45 connector × 1
Electrical Specifications	IEEE802.3 compliant
Transmission Method	10BASE-T/100BASE-TX (automatic detection)
Protocol	TCP/IP
Functions	HTTP server (remote operation, firmware updates) Dedicated ports (command control, data transfer) Remote control by controller (REMOTE lamp will light up.)

General Specifications (product guaranteed for 3 year)

Operating environment	Indoors, altitude up to 2000 m (6562-ft.), pollution degree 2
Operating temperature and humidity	0 to 40°C (32 to 104°F), 80% RH or less (non-condensating)
Storage temperature and humidity	-10 to 50°C (14 to 122°F) 80% RH or less (non-condensating)
Dielectric strength	4290 Vrms AC (sensed current: 1 mA) Between voltage input terminals and (case, interface, and output terminals) Between current direct input terminals and (case, interface, and output terminals) Between voltage input terminals and current direct input terminals
Maximum rated voltage to earth	Voltage input terminal, Current direct input terminal Measurement category III 600 V (anticipated transient overvoltage 6000 V) Measurement category II 1000 V (anticipated transient overvoltage 6000 V)
Maximum input voltage	Between voltage input terminals U: 1000 V, ±1500 Vpeak
Maximum input current	Between +/- current direct input terminals I: ±70 A, ±100 Apeak
Applicable Standards	Safety : EN61010, EMC : EN61326 Class A / EN61000-3-2 / EN61000-3-3
Rated supply voltage	100 VAC to 240 VAC, Rated power supply frequency : 50/60 Hz
Maximum rated power	40 VA or less
Dimensions	Approx. 305W(12.01") × 132H(5.20") × 256D(10.08") mm (excluding protrusions)
Mass	PW3336 series Approx. 5.2 kg (183.4 oz.) PW3337 series Approx. 5.6 kg (197.5 oz.)
Accessories	Instruction manual × 1, Measurement guide × 1, Power cord × 1

PW3335 Specifications

Input Specifications

Measurement line type	Single-phase 2-wire(1P2W)
Input methods	Voltage Isolated input, resistive voltage divider method Current Isolated input, shunt input method
Voltage measurement ranges	AUTO/ 6.0000 V/ 15.000 V/ 30.000 V/ 60.000 V/ 150.00 V/ 300.00 V/ 600.00 V/ 1.0000 kV
Current measurement ranges	AUTO/ 1.0000 mA/ 2.0000 mA/ 5.0000 mA/ 10.000 mA/ 20.000 mA/ 50.000 mA/ 100.00 mA/ 200.00 mA/ 500.00 mA/ 1.0000 A/ 2.0000 A/ 5.0000 A/ 10.000 A/ 20.000 A
Power ranges	Depends on the combination of voltage and current ranges; From 6.0000 mW to 20.000 kW (also applies to VA, var) The details are as below.
Input resistance	Voltage input terminal: 2 MΩ Current input terminal: 1 mA to 100 mA range 520 mΩ or less 200 mA to 20 A range 15 mΩ or less

Basic Measurement Specifications

Measurement method	Simultaneous voltage and current digital sampling, zero-cross simultaneous calculation																																																												
Sampling frequency	Approx. 700 kHz																																																												
A/D converter resolution	16-bit																																																												
Frequency bandwidth	DC, 0.1 Hz to 100 kHz (Values within 0.1Hz ≤ f < 10 Hz are for reference only)																																																												
Synchronization sources	U, I, DC (fixed to 200 ms)																																																												
Measurement items	<table border="0"> <tr> <td>Voltage</td> <td>Current</td> <td>Active power</td> </tr> <tr> <td>Apparent power</td> <td>Reactive power</td> <td>Power factor</td> </tr> <tr> <td>Phase angle</td> <td>Frequency</td> <td>Current integration</td> </tr> <tr> <td>Active power integration</td> <td>Integration time</td> <td></td> </tr> <tr> <td>Voltage waveform peak value</td> <td>Current waveform peak value</td> <td></td> </tr> <tr> <td>Voltage crest factor</td> <td>Current crest factor</td> <td></td> </tr> <tr> <td>Maximum current ratio</td> <td>Time average current</td> <td></td> </tr> <tr> <td>Time average active power</td> <td></td> <td></td> </tr> <tr> <td>Voltage ripple rate</td> <td>Current ripple rate</td> <td></td> </tr> <tr> <td>Harmonic parameters</td> <td></td> <td></td> </tr> <tr> <td>Harmonic voltage RMS value</td> <td>Harmonic current RMS value</td> <td></td> </tr> <tr> <td>Harmonic active power</td> <td>Total harmonic voltage distortion</td> <td></td> </tr> <tr> <td>Total harmonic current distortion</td> <td>Fundamental wave voltage</td> <td></td> </tr> <tr> <td>Fundamental wave current</td> <td>Fundamental wave active power</td> <td></td> </tr> <tr> <td>Fundamental wave apparent power</td> <td>Fundamental wave reactive power</td> <td></td> </tr> <tr> <td>Fundamental wave power factor (Displacement power factor)</td> <td></td> <td></td> </tr> <tr> <td>Fundamental wave voltage current phase difference</td> <td></td> <td></td> </tr> <tr> <td>Harmonic voltage content percentage</td> <td></td> <td></td> </tr> <tr> <td>Harmonic current content percentage</td> <td></td> <td></td> </tr> <tr> <td>Harmonic active power content percentage</td> <td></td> <td></td> </tr> </table> <p>(The following parameters can be downloaded as data via PC communication)</p> <p>Harmonic voltage phase angle Harmonic current phase angle Harmonic voltage current phase difference</p>	Voltage	Current	Active power	Apparent power	Reactive power	Power factor	Phase angle	Frequency	Current integration	Active power integration	Integration time		Voltage waveform peak value	Current waveform peak value		Voltage crest factor	Current crest factor		Maximum current ratio	Time average current		Time average active power			Voltage ripple rate	Current ripple rate		Harmonic parameters			Harmonic voltage RMS value	Harmonic current RMS value		Harmonic active power	Total harmonic voltage distortion		Total harmonic current distortion	Fundamental wave voltage		Fundamental wave current	Fundamental wave active power		Fundamental wave apparent power	Fundamental wave reactive power		Fundamental wave power factor (Displacement power factor)			Fundamental wave voltage current phase difference			Harmonic voltage content percentage			Harmonic current content percentage			Harmonic active power content percentage		
Voltage	Current	Active power																																																											
Apparent power	Reactive power	Power factor																																																											
Phase angle	Frequency	Current integration																																																											
Active power integration	Integration time																																																												
Voltage waveform peak value	Current waveform peak value																																																												
Voltage crest factor	Current crest factor																																																												
Maximum current ratio	Time average current																																																												
Time average active power																																																													
Voltage ripple rate	Current ripple rate																																																												
Harmonic parameters																																																													
Harmonic voltage RMS value	Harmonic current RMS value																																																												
Harmonic active power	Total harmonic voltage distortion																																																												
Total harmonic current distortion	Fundamental wave voltage																																																												
Fundamental wave current	Fundamental wave active power																																																												
Fundamental wave apparent power	Fundamental wave reactive power																																																												
Fundamental wave power factor (Displacement power factor)																																																													
Fundamental wave voltage current phase difference																																																													
Harmonic voltage content percentage																																																													
Harmonic current content percentage																																																													
Harmonic active power content percentage																																																													
Rectifiers	<p>AC+DC : AC+DC measurement Display of true RMS values for both voltage and current</p> <p>AC+DC U_{mn} : AC+DC measurement Display of average value rectified RMS converted values for voltage and true RMS values for current</p> <p>DC : DC measurement Display of simple averages for both voltage and current Display of values calculated by (voltage DC value) × (current DC value) for active power</p> <p>AC : AC measurement Display of values calculated by $\sqrt{(\text{AC+DC value})^2 - (\text{DC value})^2}$ for both voltage and current Display of values calculated by (AC+DC value) - (DC value) for active power</p> <p>FND : Extraction and display of the fundamental wave component from harmonic measurement</p>																																																												
Zero-cross Filter	100 Hz: 0.1 Hz to 100 Hz 500 Hz: 0.1 Hz to 500 Hz 5 kHz: 0.1 Hz to 5 kHz 100 kHz: 0.1 Hz to 100 kHz																																																												
Measurement accuracy																																																													
Voltage	<table border="1"> <thead> <tr> <th>Frequency (f)</th> <th>Input < 50% f.s.</th> <th>50% f.s. ≤ Input < 100% f.s.</th> <th>100% f.s. ≤ Input</th> </tr> </thead> <tbody> <tr> <td>DC</td> <td>±0.1%rdg.±0.1% f.s.</td> <td>±0.1%rdg.±0.1% f.s.</td> <td>±0.2%rdg.</td> </tr> <tr> <td>0.1Hz≤f<16Hz</td> <td>±0.1%rdg.±0.2% f.s.</td> <td>±0.3%rdg.</td> <td>±0.3%rdg.</td> </tr> <tr> <td>16Hz≤f<45Hz</td> <td>±0.1%rdg.±0.1% f.s.</td> <td>±0.2%rdg.</td> <td>±0.2%rdg.</td> </tr> <tr> <td>45Hz≤f≤66Hz</td> <td>±0.1%rdg.±0.05% f.s.</td> <td>±0.15%rdg.</td> <td>±0.15%rdg.</td> </tr> <tr> <td>66Hz<f≤500Hz</td> <td>±0.1%rdg.±0.1% f.s.</td> <td>±0.2%rdg.</td> <td>±0.2%rdg.</td> </tr> <tr> <td>500Hz<f≤10kHz</td> <td>±0.1%rdg.±0.2% f.s.</td> <td>±0.3%rdg.</td> <td>±0.3%rdg.</td> </tr> <tr> <td>10kHz<f≤50kHz</td> <td>±0.5%rdg.±0.3% f.s.</td> <td>±0.8%rdg.</td> <td>±0.8%rdg.</td> </tr> <tr> <td>50kHz<f≤100kHz</td> <td>±2.1%rdg.±0.3% f.s.</td> <td>±2.4%rdg.</td> <td>±2.4%rdg.</td> </tr> </tbody> </table>	Frequency (f)	Input < 50% f.s.	50% f.s. ≤ Input < 100% f.s.	100% f.s. ≤ Input	DC	±0.1%rdg.±0.1% f.s.	±0.1%rdg.±0.1% f.s.	±0.2%rdg.	0.1Hz≤f<16Hz	±0.1%rdg.±0.2% f.s.	±0.3%rdg.	±0.3%rdg.	16Hz≤f<45Hz	±0.1%rdg.±0.1% f.s.	±0.2%rdg.	±0.2%rdg.	45Hz≤f≤66Hz	±0.1%rdg.±0.05% f.s.	±0.15%rdg.	±0.15%rdg.	66Hz<f≤500Hz	±0.1%rdg.±0.1% f.s.	±0.2%rdg.	±0.2%rdg.	500Hz<f≤10kHz	±0.1%rdg.±0.2% f.s.	±0.3%rdg.	±0.3%rdg.	10kHz<f≤50kHz	±0.5%rdg.±0.3% f.s.	±0.8%rdg.	±0.8%rdg.	50kHz<f≤100kHz	±2.1%rdg.±0.3% f.s.	±2.4%rdg.	±2.4%rdg.																								
Frequency (f)	Input < 50% f.s.	50% f.s. ≤ Input < 100% f.s.	100% f.s. ≤ Input																																																										
DC	±0.1%rdg.±0.1% f.s.	±0.1%rdg.±0.1% f.s.	±0.2%rdg.																																																										
0.1Hz≤f<16Hz	±0.1%rdg.±0.2% f.s.	±0.3%rdg.	±0.3%rdg.																																																										
16Hz≤f<45Hz	±0.1%rdg.±0.1% f.s.	±0.2%rdg.	±0.2%rdg.																																																										
45Hz≤f≤66Hz	±0.1%rdg.±0.05% f.s.	±0.15%rdg.	±0.15%rdg.																																																										
66Hz<f≤500Hz	±0.1%rdg.±0.1% f.s.	±0.2%rdg.	±0.2%rdg.																																																										
500Hz<f≤10kHz	±0.1%rdg.±0.2% f.s.	±0.3%rdg.	±0.3%rdg.																																																										
10kHz<f≤50kHz	±0.5%rdg.±0.3% f.s.	±0.8%rdg.	±0.8%rdg.																																																										
50kHz<f≤100kHz	±2.1%rdg.±0.3% f.s.	±2.4%rdg.	±2.4%rdg.																																																										
Current	<table border="1"> <thead> <tr> <th>Frequency (f)</th> <th>Input < 50% f.s.</th> <th>50% f.s. ≤ Input < 100% f.s.</th> <th>100% f.s. ≤ Input</th> </tr> </thead> <tbody> <tr> <td>DC</td> <td>±0.1%rdg.±0.1% f.s.</td> <td>±0.1%rdg.±0.1% f.s.</td> <td>±0.2%rdg.</td> </tr> <tr> <td>0.1Hz≤f<16Hz</td> <td>±0.1%rdg.±0.2% f.s.</td> <td>±0.3%rdg.</td> <td>±0.3%rdg.</td> </tr> <tr> <td>16Hz≤f<45Hz</td> <td>±0.1%rdg.±0.1% f.s.</td> <td>±0.2%rdg.</td> <td>±0.2%rdg.</td> </tr> <tr> <td>45Hz≤f≤66Hz</td> <td>±0.1%rdg.±0.05% f.s.</td> <td>±0.15%rdg.</td> <td>±0.15%rdg.</td> </tr> <tr> <td>66Hz<f≤500Hz</td> <td>±0.1%rdg.±0.1% f.s.</td> <td>±0.2%rdg.</td> <td>±0.2%rdg.</td> </tr> <tr> <td>500Hz<f≤1kHz</td> <td>±0.1%rdg.±0.2% f.s.</td> <td>±0.3%rdg.</td> <td>±0.3%rdg.</td> </tr> <tr> <td>1kHz<f≤10kHz</td> <td>±(0.03+0.07×F)%rdg.±0.2% f.s.</td> <td>±(0.23+0.07×F)%rdg.</td> <td>±(0.23+0.07×F)%rdg.</td> </tr> <tr> <td>10kHz<f≤100kHz</td> <td>±(0.3+0.04×F)%rdg.±0.3% f.s.</td> <td>±(0.6+0.04×F)%rdg.</td> <td>±(0.6+0.04×F)%rdg.</td> </tr> </tbody> </table>	Frequency (f)	Input < 50% f.s.	50% f.s. ≤ Input < 100% f.s.	100% f.s. ≤ Input	DC	±0.1%rdg.±0.1% f.s.	±0.1%rdg.±0.1% f.s.	±0.2%rdg.	0.1Hz≤f<16Hz	±0.1%rdg.±0.2% f.s.	±0.3%rdg.	±0.3%rdg.	16Hz≤f<45Hz	±0.1%rdg.±0.1% f.s.	±0.2%rdg.	±0.2%rdg.	45Hz≤f≤66Hz	±0.1%rdg.±0.05% f.s.	±0.15%rdg.	±0.15%rdg.	66Hz<f≤500Hz	±0.1%rdg.±0.1% f.s.	±0.2%rdg.	±0.2%rdg.	500Hz<f≤1kHz	±0.1%rdg.±0.2% f.s.	±0.3%rdg.	±0.3%rdg.	1kHz<f≤10kHz	±(0.03+0.07×F)%rdg.±0.2% f.s.	±(0.23+0.07×F)%rdg.	±(0.23+0.07×F)%rdg.	10kHz<f≤100kHz	±(0.3+0.04×F)%rdg.±0.3% f.s.	±(0.6+0.04×F)%rdg.	±(0.6+0.04×F)%rdg.																								
Frequency (f)	Input < 50% f.s.	50% f.s. ≤ Input < 100% f.s.	100% f.s. ≤ Input																																																										
DC	±0.1%rdg.±0.1% f.s.	±0.1%rdg.±0.1% f.s.	±0.2%rdg.																																																										
0.1Hz≤f<16Hz	±0.1%rdg.±0.2% f.s.	±0.3%rdg.	±0.3%rdg.																																																										
16Hz≤f<45Hz	±0.1%rdg.±0.1% f.s.	±0.2%rdg.	±0.2%rdg.																																																										
45Hz≤f≤66Hz	±0.1%rdg.±0.05% f.s.	±0.15%rdg.	±0.15%rdg.																																																										
66Hz<f≤500Hz	±0.1%rdg.±0.1% f.s.	±0.2%rdg.	±0.2%rdg.																																																										
500Hz<f≤1kHz	±0.1%rdg.±0.2% f.s.	±0.3%rdg.	±0.3%rdg.																																																										
1kHz<f≤10kHz	±(0.03+0.07×F)%rdg.±0.2% f.s.	±(0.23+0.07×F)%rdg.	±(0.23+0.07×F)%rdg.																																																										
10kHz<f≤100kHz	±(0.3+0.04×F)%rdg.±0.3% f.s.	±(0.6+0.04×F)%rdg.	±(0.6+0.04×F)%rdg.																																																										

Active power			
Frequency (f)	Input < 50% f.s.	50% f.s. ≤ Input < 100% f.s.	100% f.s. ≤ Input
DC	±0.1%rdg.±0.1% f.s.	±0.1%rdg.±0.1% f.s.	±0.2%rdg.
0.1Hz≤f<16Hz	±0.1%rdg.±0.2% f.s.	±0.3%rdg.	±0.3%rdg.
16Hz≤f<45Hz	±0.1%rdg.±0.1% f.s.	±0.2%rdg.	±0.2%rdg.
45Hz≤f≤66Hz	±0.1%rdg.±0.05% f.s.	±0.15%rdg.	±0.15%rdg.
66Hz<f≤500Hz	±0.1%rdg.±0.1% f.s.	±0.2%rdg.	±0.2%rdg.
500Hz<f≤1kHz	±0.1%rdg.±0.2% f.s.	±0.3%rdg.	±0.3%rdg.
1kHz<f≤10kHz	±(0.03+0.07×F)%rdg.±0.2% f.s.	±(0.23+0.07×F)%rdg.	±(0.23+0.07×F)%rdg.
10kHz<f≤50kHz	±(0.07×F)%rdg.±0.3% f.s.	±(0.3+0.07×F)%rdg.	±(0.3+0.07×F)%rdg.
50kHz<f≤100kHz	±(0.6+0.07×F)%rdg.±0.3% f.s.	±(0.9+0.07×F)%rdg.	±(0.9+0.07×F)%rdg.

Effective measuring range	<p>Voltage 1% to 150% of the range (1000 V range, up to 1000 V)</p> <p>Current 1% to 150% of the range</p> <p>Active power 0% to 225% of the range (when using 1000 V range, up to 150%) However, valid when the voltage and current fall within the effective measurement range.</p>
Maximum effective peak voltage	±600% of each voltage range However, for 300 V, 600 V, and 1000 V ranges, ±1500 V peak
Maximum effective peak current	±600% of each current range However, for 20 A range, ±60 A peak
Guaranteed accuracy period	1 year
Conditions of guaranteed accuracy	<p>Temperature and humidity range: 23°C±5°C (73°F±9°F), 80% RH or less</p> <p>Warm-up time: 30 minutes</p> <p>Input: Sine wave input, power factor of 1, voltage to earth of 0 V, after zero-adjustment; within range in which the fundamental wave satisfies synchronization source conditions</p>
Temperature coefficient	±0.03% f.s. per °C or less. However, for 1 mA range, ±0.06% f.s. per °C or less.
Effect of power factor	±0.1% f.s. or less (45 to 66 Hz, at power factor = 0)
Effect of common mode voltage	Internal circuitry voltage/current phase difference: ±0.0573°
Effect of magnetic field	400 A/m, DC and 50 Hz/60 Hz magnetic field
Effect of self-heating	<p>With input of at least 15 A to current input terminals</p> <p>Current AC input signal ±(0.025+0.005×(I-15))%rdg. or less DC input signal 200 mA/ 500 mA/ 1 A/ 2 A/ 5 A/ 10 A/ 20 A range ±((0.025+0.005×(I-15))% rdg.+(0.5+0.1×(I-15))μA) or less 1 mA/ 2 mA/ 5 mA/ 10 mA/ 20 mA/ 50 mA/ 100 mA range ±((0.025+0.005×(I-15))% rdg.+(5+1×(I-15))μA) or less I: Current read value (A)</p> <p>Active power (above current influence quantity) × (voltage read value) or less The effects of self-heating will continue to manifest themselves until the input resistance temperature falls, even if the current value is low.</p>

Range table (Power ranges)

Voltage	Current								
	6.0000 V	15.000 V	30.000 V	60.000 V	150.00 V	300.00 V	600.00 V	1.0000 kV	
1.0000 mA	6.0000 mW	15.000 mW	30.000 mW	60.000 mW	150.00 mW	300.00 mW	600.00 mW	1.0000 W	
2.0000 mA	12.000 mW	30.000 mW	60.000 mW	120.00 mW	300.00 mW	600.00 mW	1.2000 W	2.0000 W	
5.0000 mA	30.000 mW	75.000 mW	150.00 mW	300.00 mW	750.00 mW	1.5000 W	3.0000 W	5.0000 W	
10.000 mA	60.000 mW	150.00 mW	300.00 mW	600.00 mW	1.5000 W	3.0000 W	6.0000 W	10.000 W	
20.000 mA	120.00 mW	300.00 mW	600.00 mW	1.2000 W	3.0000 W	6.0000 W	12.000 W	20.000 W	
50.000 mA	300.00 mW	750.00 mW	1.5000 W	3.0000 W	7.5000 W	15.000 W	30.000 W	50.000 W	
100.00 mA	600.00 mW	1.5000 W	3.0000 W	6.0000 W	15.000 W	30.000 W	60.000 W	100.00 W	
200.00 mA	1.2000 W	3.0000 W	6.0000 W	12.000 W	30.000 W	60.000 W	120.00 W	200.00 W	
500.00 mA	3.0000 W	7.5000 W	15.000 W	30.000 W	75.000 W	150.00 W	300.00 W	500.00 W	
1.0000 A	6.0000 W	15.000 W	30.000 W	60.000 W	150.00 W	300.00 W	600.00 W	1.0000 kW	
2.0000 A	12.000 W	30.000 W	60.000 W	120.00 W	300.00 W	600.00 W	1.2000 kW	2.0000 kW	
5.0000 A	30.000 W	75.000 W	150.00 W	300.00 W	750.00 W	1.5000 kW	3.0000 kW	5.0000 kW	
10.000 A	60.000 W	150.00 W	300.00 W	600.00 W	1.5000 kW	3.0000 kW	6.0000 kW	10.000 kW	
20.000 A	120.00 W	300.00 W	600.00 W	1.2000 kW	3.0000 kW	6.0000 kW	12.000 kW	20.000 kW	



Voltage/ Current/ Active Power Measurement Specifications

Measurement types	Rectifiers: AC+DC, DC, AC, FND, AC+DC Umn
Effective measuring range	Voltage ±1% to ±150% of the range. However, up to ±1500 V peak value and 1000 V RMS value Current ±1% to ±150% of the range Active Power ±0% to ±225% of the range. However, valid when the voltage and current fall within the effective measurement range.
Display range	Voltage Up to ±152% of the range. However, zero-suppression when less than ±0.5% Current Up to ±152% of the range. However, zero-suppression when less than ±0.5% or less than ±9 µA. Active Power ±0% to ±231.04% of the range (no zero-suppression)
Polarity	Voltage/ Current Displayed when using DC rectifier Active Power Positive : Power consumption (no polarity display) Negative : generation or regenerated power

Voltage Waveform Peak Value/ Current Waveform Peak Value Measurement Specifications

Measurement method	Measures the voltage waveform's peak value (for both positive and negative polarity) based on sampled instantaneous voltage values.																																																
Range configuration	Voltage <table border="1"> <thead> <tr> <th>Voltage range</th> <th>Voltage peak range</th> </tr> </thead> <tbody> <tr><td>6.0000 V</td><td>36.000 V</td></tr> <tr><td>15.000 V</td><td>90.000 V</td></tr> <tr><td>30.000 V</td><td>180.00 V</td></tr> <tr><td>60.000 V</td><td>360.00 V</td></tr> <tr><td>150.00 V</td><td>900.00 V</td></tr> <tr><td>300.00 V</td><td>1.8000 kV</td></tr> <tr><td>600.00 V</td><td>3.6000 kV</td></tr> <tr><td>1.0000 kV</td><td>6.0000 kV</td></tr> </tbody> </table> Current <table border="1"> <thead> <tr> <th>Current range</th> <th>Current peak range</th> </tr> </thead> <tbody> <tr><td>1.0000 mA</td><td>6.0000 mA</td></tr> <tr><td>2.0000 mA</td><td>12.000 mA</td></tr> <tr><td>5.0000 mA</td><td>30.000 mA</td></tr> <tr><td>10.000 mA</td><td>60.000 mA</td></tr> <tr><td>20.000 mA</td><td>120.00 mA</td></tr> <tr><td>50.000 mA</td><td>300.00 mA</td></tr> <tr><td>100.00 mA</td><td>600.00 mA</td></tr> <tr><td>200.00 mA</td><td>1.2000 A</td></tr> <tr><td>500.00 mA</td><td>3.0000 A</td></tr> <tr><td>1.0000 A</td><td>6.0000 A</td></tr> <tr><td>2.0000 A</td><td>12.000 A</td></tr> <tr><td>5.0000 A</td><td>30.000 A</td></tr> <tr><td>10.000 A</td><td>60.000 A</td></tr> <tr><td>20.000 A</td><td>120.00 A</td></tr> </tbody> </table>	Voltage range	Voltage peak range	6.0000 V	36.000 V	15.000 V	90.000 V	30.000 V	180.00 V	60.000 V	360.00 V	150.00 V	900.00 V	300.00 V	1.8000 kV	600.00 V	3.6000 kV	1.0000 kV	6.0000 kV	Current range	Current peak range	1.0000 mA	6.0000 mA	2.0000 mA	12.000 mA	5.0000 mA	30.000 mA	10.000 mA	60.000 mA	20.000 mA	120.00 mA	50.000 mA	300.00 mA	100.00 mA	600.00 mA	200.00 mA	1.2000 A	500.00 mA	3.0000 A	1.0000 A	6.0000 A	2.0000 A	12.000 A	5.0000 A	30.000 A	10.000 A	60.000 A	20.000 A	120.00 A
Voltage range	Voltage peak range																																																
6.0000 V	36.000 V																																																
15.000 V	90.000 V																																																
30.000 V	180.00 V																																																
60.000 V	360.00 V																																																
150.00 V	900.00 V																																																
300.00 V	1.8000 kV																																																
600.00 V	3.6000 kV																																																
1.0000 kV	6.0000 kV																																																
Current range	Current peak range																																																
1.0000 mA	6.0000 mA																																																
2.0000 mA	12.000 mA																																																
5.0000 mA	30.000 mA																																																
10.000 mA	60.000 mA																																																
20.000 mA	120.00 mA																																																
50.000 mA	300.00 mA																																																
100.00 mA	600.00 mA																																																
200.00 mA	1.2000 A																																																
500.00 mA	3.0000 A																																																
1.0000 A	6.0000 A																																																
2.0000 A	12.000 A																																																
5.0000 A	30.000 A																																																
10.000 A	60.000 A																																																
20.000 A	120.00 A																																																
Measurement accuracy	±2.0%f.s. at DC and when 10 Hz ≤ f ≤ 1 kHz (f.s.: current peak range). Provided as reference value when 0.1 Hz ≤ f < 10 Hz and when 1 kHz < f. The above measurement accuracy is multiplied by 2 for the 1 mA range.																																																
Effective measuring range	±5% to ±100% of current peak range, however, up to ±60 A																																																
Display range	Up to ±102% of current peak range, however, the value 0 will be displayed if the current RMS value triggers the instrument's zero suppression function.																																																

Voltage Crest Factor/Current Crest Factor Measurement Specifications

Measurement method	Calculates the ratio of the voltage waveform peak value to the voltage RMS value.
Effective measuring range	As per voltage and voltage waveform peak value, or current and current waveform peak value effective measurement ranges.
Display range	1.0000 to 612.00 (no polarity)

Voltage Ripple Rate/ Current Ripple Rate Measurement Specifications

Measurement method	Calculates the AC component (peak to peak [peak width]) as a proportion of the voltage or current DC component.
Effective measuring range	As per voltage and voltage waveform peak value, or current and current waveform peak value effective measurement ranges.
Display range	0.00 to 500.00 (No polarity)

Apparent Power/ Reactive Power/ Power Factor/ Phase Angle Measurement Specifications

Measurement types	Rectifiers Apparent Power/ Reactive Power/ Power Factor AC+DC, AC, FND, AC+DC Umn Phase Angle AC, FND
Effective measuring range	As per voltage, current, and active power effective measurement ranges
Display range	Apparent Power/ Reactive Power 0% to 231.04% of the range (no zero-suppression) Power Factor ±0.0000 to ±1.0000 Phase Angle +180.00 to -180.00

Polarity	Reactive Power/ Power Factor/ Phase Angle Polarity is assigned according to the lead/lag relationship of the voltage waveform rising edge and the current waveform rising edge. +: When current lags voltage (no polarity display) -: When current leads voltage
----------	---

Power Calculation Formulas

S : Apparent power	$S = U \times I$
Q : Reactive power	$Q = si\sqrt{S^2 - P^2}$
λ : Power factor	$\lambda = si P/S $
φ : Phase angle	$\phi = si \cos^{-1} \lambda $ (±90° to ±180°) $\phi = si 180 - \cos^{-1} \lambda $ (0° to ±90°)

U: Voltage, I: Current, P: Active Power, si: Polarity symbol (acquired based on voltage waveform and current waveform lead and lag)

Frequency Measurement Specifications

Number of measurement channels	2 (Voltage, current)
Measurement method	Calculated from input waveform period (reciprocal method)
Measurement ranges	100 Hz/ 500 Hz/ 5 kHz/ 100 kHz (linked to zero-cross filter)
Measurement accuracy	±0.1% rdg. ±1 dgt. However, for 1 mA range, ±0.2% rdg. ±1 dgt.
Effective measuring range	0.1 Hz to 100 kHz For sine wave input that is at least 20% of the measurement source's measurement range Measurement lower limit frequency setting: 0.1 sec. / 1 sec. / 10 sec. (linked to synchronization timeout setting)
Display format	0.1000 Hz to 9.9999 Hz, 9.900 Hz to 99.999 Hz, 99.00 Hz to 999.99 Hz, 9.900 kHz to 99.999 kHz, 99.00 kHz to 100.00 kHz

Maximum Current Ratio Measurement Specifications (MCR)

Measurement method	Calculates the ratio of the current crest factor to the power factor. (MCR) = (Current Crest Factor) / (Power Factor)
Effective measuring range	As per power factor (voltage, current, active power) and current crest factor (current, current waveform peak value) effective measurement ranges.
Display range	1.0000 to 6.1200 M (no polarity)

Time Average Current/ Time Average Active Power Measurement Specifications

Measurement method	Calculates the average by dividing the current or active power integrated value by the integration time.
Measurement accuracy	(Current or Active power measurement accuracy) ± (±0.01% rdg. ±1 dgt.)
Effective measuring range	As per the current or active power integration effective measurement range.
Display range	Time Average Current ±0% to ±612% of the range (Has polarity when using the DC rectifier.) Time Average Active Power ±0% to ±3745.4% of the range (Has polarity)

Functional Specifications

Auto-range (AUTO)	Automatically changes the voltage and current range according to the input. Range up: The range is increased when input exceeds 150% of the range or when the peak is exceeded. Range down: The range is decreased when input falls below 15% of the range. However, the range is not decreased when the peak is exceeded at the lower range. The input level is monitored, and the range is switched over multiple ranges. Range select can be used to disable ranges so that they are not selected.																
Range select	Selects whether to enable (turn on) or disable (turn off) individual voltage and current ranges. Enabled (use): Ranges can be selected with the range keys. Range switching occurs using auto-range operation. Range switching occurs during auto-range integration. Disabled (do not use): Ranges cannot be selected with the range keys. Range switching does not occur using auto-range operation. Range switching does not occur during auto-range integration.																
Zero-cross filter's threshold level	Sets the zero-cross filter's threshold level for voltage and current ranges. Set from 1% to 15% (in 1% intervals). Synchronization occurs when the percentage level set for each measurement range is exceeded.																
Averaging	Averages the voltage, current, active power, apparent power, and reactive power. (Other than harmonic measurement parameters.) The power factor and phase angle are calculated from averaged data. Averaging is not performed for parameters other than those listed above. Method: Simple averaging Number of averaging iterations and display update interval <table border="1"> <thead> <tr> <th>Number of averaging iterations</th> <th>Display update interval</th> </tr> </thead> <tbody> <tr><td>1 (OFF)</td><td>200 ms</td></tr> <tr><td>2</td><td>400 ms</td></tr> <tr><td>5</td><td>1 s</td></tr> <tr><td>10</td><td>2 s</td></tr> <tr><td>25</td><td>5 s</td></tr> <tr><td>50</td><td>10 s</td></tr> <tr><td>100</td><td>20 s</td></tr> </tbody> </table>	Number of averaging iterations	Display update interval	1 (OFF)	200 ms	2	400 ms	5	1 s	10	2 s	25	5 s	50	10 s	100	20 s
Number of averaging iterations	Display update interval																
1 (OFF)	200 ms																
2	400 ms																
5	1 s																
10	2 s																
25	5 s																
50	10 s																
100	20 s																
Scaling (VT, CT)	Applies user-defined VT and CT ratio settings to measured values. VT ratio setting range OFF (1.0), 0.001 to 1000 CT ratio setting range OFF (1.0), 0.001 to 1000																
Hold	<ul style="list-style-type: none"> Stops display updates for all measured values and fixes the display values at that point in time. Measurement data acquired by communications is also fixed at that point in time. Internal calculations (including integration and integration elapsed time) will continue. Analog output and waveform output are not held 																

Maximum value/minimum value hold (MAX/MIN HOLD)	<ul style="list-style-type: none"> • Detects maximum and minimum measured values (except current integration, active power integration, integration elapsed time, time average current, and time average active power values) as well as maximum and minimum values for the voltage waveform peak and current waveform peak and holds them on the display. • For data with polarity, display of the maximum value and minimum value for the data's absolute values is held (so that both positive and negative polarity values are shown). However, this does not apply to the voltage waveform peak value or the current waveform peak value. • Internal calculations (including integration and integration elapsed time) will continue. • The maximum and minimum values during integration are detected (maximum/minimum value measurement during the integration interval). • Analog output and waveform output are not held.
Zero Adjustment	Zeroes out the voltage and current input offset.
Key-lock	Disables key input in the measurement state, except for the KEY LOCK key.
Backup	Backs up settings and integration data if the instrument is turned off and if a power outage occurs.
System Reset	Initializes the instrument's settings.

Integration Measurement Specifications

Integration operation modes	<p>Switchable between fixed-range integration and auto-range integration.</p> <p>Fixed-range integration Integration can be performed for all voltage and current ranges. The voltage and current ranges are fixed once integration starts.</p> <p>Auto-range integration Integration can be performed for all voltage ranges. The current is set to auto-range operation using ranges from 200 mA to 20 A. The integrated value for each range can be displayed by switching the current range (200 mA to 20 A) while integration is stopped.</p>
Measurement items and display	<p>Simultaneous integration of the following 6 parameters:</p> <ul style="list-style-type: none"> Positive current integrated value (Ah+) Negative current integrated value (Ah-) Sum of current integrated values (Ah) Positive active power integrated value (Wh+) Negative active power integrated value (Wh-) Sum of active power integrated values (Wh)
Measurement types	<p>Rectifiers: AC+DC, AC+DC Umn</p> <p>Current: Displays the result of integrating current RMS value data (display values) once every display update interval as an integrated value.</p> <p>Active power: Displays the result of integrating active power values by polarity calculated once every cycle for the selected synchronization source as integrated values.</p> <p>Rectifier: DC Displays the result of integrating instantaneous data obtained by sampling both current and active power by polarity as integrated values (these values are not integrated values for the DC component when active power contains both DC and AC components)</p>
Integration time	1 min. to 10000 hr., settable in 1 min. blocks
Integration time accuracy	±0.01% rdg. ±1 dgt.
Integration measurement accuracy	(Current or active power measurement accuracy) ± (±0.01% rdg. ±1 dgt.)
Effective measuring range	Until PEAK OVER U lamp or PEAK OVER I lamp lights up.
Display resolution	999999 (6 digits + decimal point)
Functions	<ul style="list-style-type: none"> • Stopping integration based on integration time setting (timer) • Stopping/starting integration and resetting integrated values based on external control • Displaying the integration elapsed time (displayed as TIME on panel display) • Additional integration by repeatedly starting/stopping integration • Backing up integrated values and the integration elapsed time during power outages • Stopping integration when power returns

Harmonic Measurement Specifications

Measurement method	<p>Zero-cross simultaneous calculation method</p> <p>Uniform thinning between zero-cross events after processing with a digital antialiasing filter</p> <p>Interpolation calculations (Lagrange interpolation)</p> <p>When the synchronization frequency falls within the 45 Hz to 66 Hz range: IEC 61000-4-7:2002 compliant</p> <p>Gaps and overlaps may occur if the measurement frequency is not 50 Hz or 60 Hz.</p> <p>When the synchronization frequency falls outside the 45 Hz to 66 Hz range: No gaps or overlap will occur.</p>																										
Synchronization source	Conforms to synchronization source (SYNC) for the basic measurement specifications.																										
Measurement items	<table border="0"> <tr> <td>Harmonic voltage RMS value</td> <td>Harmonic voltage content percentage</td> </tr> <tr> <td>Harmonic voltage phase angle</td> <td>Harmonic current RMS value</td> </tr> <tr> <td>Harmonic current content percentage</td> <td>Harmonic current phase angle</td> </tr> <tr> <td>Harmonic active power</td> <td></td> </tr> <tr> <td>Harmonic active power content percentage</td> <td></td> </tr> <tr> <td>Harmonic voltage current phase difference</td> <td></td> </tr> <tr> <td>Total harmonic voltage distortion</td> <td>Total harmonic current distortion</td> </tr> <tr> <td>Fundamental wave voltage</td> <td>Fundamental wave current</td> </tr> <tr> <td>Fundamental wave active power</td> <td>Fundamental wave apparent power</td> </tr> <tr> <td>Fundamental wave reactive power</td> <td>Fundamental wave power factor</td> </tr> <tr> <td>Fundamental wave voltage current phase difference</td> <td></td> </tr> </table> <p>(The following parameters can be downloaded as data with communications)</p> <table border="0"> <tr> <td>Harmonic voltage phase angle</td> <td>Harmonic current phase angle</td> </tr> <tr> <td>Harmonic voltage current phase difference</td> <td></td> </tr> </table>	Harmonic voltage RMS value	Harmonic voltage content percentage	Harmonic voltage phase angle	Harmonic current RMS value	Harmonic current content percentage	Harmonic current phase angle	Harmonic active power		Harmonic active power content percentage		Harmonic voltage current phase difference		Total harmonic voltage distortion	Total harmonic current distortion	Fundamental wave voltage	Fundamental wave current	Fundamental wave active power	Fundamental wave apparent power	Fundamental wave reactive power	Fundamental wave power factor	Fundamental wave voltage current phase difference		Harmonic voltage phase angle	Harmonic current phase angle	Harmonic voltage current phase difference	
Harmonic voltage RMS value	Harmonic voltage content percentage																										
Harmonic voltage phase angle	Harmonic current RMS value																										
Harmonic current content percentage	Harmonic current phase angle																										
Harmonic active power																											
Harmonic active power content percentage																											
Harmonic voltage current phase difference																											
Total harmonic voltage distortion	Total harmonic current distortion																										
Fundamental wave voltage	Fundamental wave current																										
Fundamental wave active power	Fundamental wave apparent power																										
Fundamental wave reactive power	Fundamental wave power factor																										
Fundamental wave voltage current phase difference																											
Harmonic voltage phase angle	Harmonic current phase angle																										
Harmonic voltage current phase difference																											

FFT processing	FFT processing word length : 32 bits Number of FFT points : 4096 points	
Window function	Rectangular	
Analysis window width	45 Hz ≤ f < 56 Hz : 178.57 ms to 222.22 ms (10 cycles) 56 Hz ≤ f < 66 Hz : 181.82 ms to 214.29 ms (12 cycles) Frequencies other than the above : 185.92 ms to 214.08 ms	
Data update rate	Depends on window width.	
Maximum analysis order	Synchronization frequency (f) range	Analysis order
	10 Hz ≤ f < 45 Hz	50th
	45 Hz ≤ f < 56 Hz	50th
	56 Hz ≤ f ≤ 66 Hz	50th
	66 Hz < f ≤ 100 Hz	50th
	100 Hz < f ≤ 200 Hz	40th
	200 Hz < f ≤ 300 Hz	25th
	300 Hz < f ≤ 500 Hz	15th
	500 Hz < f ≤ 640 Hz	11th
Analysis order upper limit setting	2nd to 50th	
Measurement accuracy	f.s.: Measurement range	
	Frequency (f)	Voltage, Current, Active power
	DC	±0.4% rdg. ±0.2% f.s.
	10 Hz ≤ f < 30 Hz	±0.4% rdg. ±0.2% f.s.
	30 Hz ≤ f ≤ 400 Hz	±0.3% rdg. ±0.1% f.s.
	400 Hz < f ≤ 1 kHz	±0.4% rdg. ±0.2% f.s.
	1 kHz < f ≤ 5 kHz	±1.0% rdg. ±0.5% f.s.
	5 kHz < f ≤ 8 kHz	±4.0% rdg. ±1.0% f.s.
	<ul style="list-style-type: none"> • When using the 1 mA/ 2 mA range: Add ±1 μA to 10 Hz to 8 kHz measurement accuracy for current. Add (±1 μA) × (voltage read value) to 10 Hz to 8 kHz measurement accuracy for active power. • When using the 200 mA/ 500 mA/ 1 A/ 2 A/ 5 A/ 10 A/ 20 A range: Add ±1 mA to DC measurement accuracy for current. Add (±1 mA) × (voltage read value) to DC measurement accuracy for active power. • When using the 1 mA/ 2 mA/ 5 mA/ 10 mA/ 20 mA/ 50 mA/ 100 mA range: Add ±10 μA to DC measurement accuracy for current. Add (±10 μA) × (voltage read value) to DC measurement accuracy for active power. 	

Display Specifications

Display	7-segment LED
Number of display parameters	4 (display area a, b, c, and d)
Display resolution	Other than integrated values: 99999 count (5 digits) Integrated values: 999999 count (6 digits)
Display update rate	200 ms ±50 ms (approx. 5 updates per sec.) to 20 s (varies with number of averaging iterations setting)

Synchronized control

Functions	The timing of calculations; display updates; data updates; integration start, stop, and reset events; display hold operation; key lock operation; and zero-adjustment operation for the secondary PW3335 series is synchronized with the primary PW3335 series. Synchronization with the PW3336 series and PW3337 series is also supported.
Terminal	BNC terminal × 1 (non-isolated)
Terminal name	External synchronization terminal (EXT.SYNC)
I/O settings	<p>Off Synchronized control function off (signals input to the external synchronization terminal (EXT.SYNC) are ignored)</p> <p>In The external synchronization terminal (EXT.SYNC) is set to input, and a dedicated synchronization signal can be input (secondary).</p> <p>Out The external synchronization terminal (EXT.SYNC) is set to output, and a dedicated synchronization signal can be output (primary).</p>
Number of units for which synchronized control can be performed	Up to 7 secondaries per primary (total of 8 units including the PW3336/PW3337 series)

External Current Sensor Input Specifications (PW3335-03 and PW3335-04)

Terminal	Isolated BNC terminals
Current sensor type switching	Off / TYPE 1 / TYPE 2 When set to off, input from the external current sensor input terminal is ignored.
Current sensor options	<p>TYPE1 (100 A to 5000 A sensors) 9660, 9661, 9669, CT9667-01/-02/-03</p> <p>TYPE2 (20 A to 2000 A sensors, Power supply is required to use) CT6862-05, CT6872, CT6872-01, CT6863-05, CT6873, CT6873-01, CT6875A, CT6875A-1, CT6876A, CT6876A-1, CT6877A, CT6877A-1, CT6841A, CT6843A, CT6844A, CT6845A, CT6846A, 9272-05</p>
Current measurement range	Auto/ 1 A/ 2 A/ 5 A (range noted on panel) Can be read directly by manually setting the CT ratio.
Constraints	Auto-range integration not supported.
Power range configuration	Depends on the combination of voltage and current ranges; from 24.000 W to 5.0000 MW (also applies to VA, var)



Measurement accuracy			
Current/ Active Power			
Frequency (f)	Input < 50%f.s.	50%f.s. ≤ Input < 100%f.s.	100%f.s. ≤ Input
DC	±0.1%rdg.±0.2%f.s.	±0.1%rdg.±0.2%f.s.	±0.3%rdg.
0.1Hz≤f<16Hz	±0.1%rdg.±0.2%f.s.	±0.3%rdg.	±0.3%rdg.
16Hz≤f<45Hz	±0.1%rdg.±0.2%f.s.	±0.3%rdg.	±0.3%rdg.
45Hz≤f≤66Hz	±0.1%rdg.±0.1%f.s.	±0.2%rdg.	±0.2%rdg.
66Hz<f≤500Hz	±0.1%rdg.±0.2%f.s.	±0.3%rdg.	±0.3%rdg.
500Hz<f≤1kHz	±0.1%rdg.±0.2%f.s.	±0.3%rdg.	±0.3%rdg.

Current			
Frequency (f)	Input < 50%f.s.	50%f.s. ≤ Input < 100%f.s.	100%f.s. ≤ Input
1kHz<f≤10kHz	±(0.03+0.07×F)%rdg.±0.2%f.s.	±(0.23+0.07×F)%rdg.	±(0.23+0.07×F)%rdg.
10kHz<f≤100kHz	±(0.3+0.04×F)%rdg.±0.3%f.s.	±(0.6+0.04×F)%rdg.	±(0.6+0.04×F)%rdg.

Active Power			
Frequency (f)	Input < 50%f.s.	50%f.s. ≤ Input < 100%f.s.	100%f.s. ≤ Input
1kHz<f≤10kHz	±(0.03+0.07×F)%rdg.±0.2%f.s.	±(0.23+0.07×F)%rdg.	±(0.23+0.07×F)%rdg.
10kHz<f≤50kHz	±(0.07×F)%rdg.±0.3%f.s.	±(0.3+0.07×F)%rdg.	±(0.3+0.07×F)%rdg.
50kHz<f≤100kHz	±(0.6+0.07×F)%rdg.±0.3%f.s.	±(0.9+0.07×F)%rdg.	±(0.9+0.07×F)%rdg.

- Values for f.s. depend on measurement ranges.
- "F" in the tables refers to the frequency in kHz.
- To obtain the current or active power accuracy, add the current sensor's accuracy to the above current and active power accuracy figures.
- The effective measurement range and frequency characteristics conform to the current sensor's specifications.
- The following input are considered reference values:
Values for voltage, current, and active power for which 0.1 Hz ≤ f < 10 Hz.
Values for voltage and active power in excess of 220 V for which 10 Hz ≤ f < 16 Hz.
Values for voltage and active power in excess of 750 V for which 30 kHz < f ≤ 100 kHz.
- When using the CT684xA series, add ±2 mV to the CT684xA series accuracy after performing CT684xA series zero adjustment using the 1 A range noted on the panel.

Temperature coefficient	Current, active power: ±0.08%f.s./°C or less (instrument temperature coefficient; f.s.: instrument measurement range) Add current sensor temperature coefficient to above.														
Effect of power factor	Instrument: ±0.15%f.s. or less (45 to 66 Hz with power factor = 0) Internal circuit voltage/current phase difference: ±0.0859° Add the current sensor phase accuracy to the internal circuit voltage/current phase difference noted above.														
Current waveform peak value measurement specifications	±2.0% at DC or 10 Hz ≤ f ≤ 1 kHz (f.s.: current peak range) Add the current sensor accuracy to the above.														
Harmonic measurement accuracy	External current sensor input instrument measurement accuracy only <table border="1"> <thead> <tr> <th>Frequency (f)</th> <th>Voltage, Current, Active power</th> </tr> </thead> <tbody> <tr> <td>DC</td> <td>±0.4% rdg.±0.2%f.s.</td> </tr> <tr> <td>10 Hz ≤ f < 30 Hz</td> <td>±0.4% rdg.±0.2%f.s.</td> </tr> <tr> <td>30 Hz ≤ f ≤ 400 Hz</td> <td>±0.3% rdg.±0.1%f.s.</td> </tr> <tr> <td>400 Hz < f ≤ 1 kHz</td> <td>±0.4% rdg.±0.2%f.s.</td> </tr> <tr> <td>1 kHz < f ≤ 5 kHz</td> <td>±1.0% rdg.±0.5%f.s.</td> </tr> <tr> <td>5 kHz < f ≤ 8 kHz</td> <td>±4.0% rdg.±1.0%f.s.</td> </tr> </tbody> </table> <ul style="list-style-type: none"> • Values for f.s. depend on measurement ranges. • To obtain the current or active power accuracy, add the current sensor's accuracy to the above current and active power accuracy figures. • When using the CT684xA series, add ±2 mV to the CT684xA series accuracy after performing CT684xA series zero adjustment using the 1 A range noted on the panel. 	Frequency (f)	Voltage, Current, Active power	DC	±0.4% rdg.±0.2%f.s.	10 Hz ≤ f < 30 Hz	±0.4% rdg.±0.2%f.s.	30 Hz ≤ f ≤ 400 Hz	±0.3% rdg.±0.1%f.s.	400 Hz < f ≤ 1 kHz	±0.4% rdg.±0.2%f.s.	1 kHz < f ≤ 5 kHz	±1.0% rdg.±0.5%f.s.	5 kHz < f ≤ 8 kHz	±4.0% rdg.±1.0%f.s.
Frequency (f)	Voltage, Current, Active power														
DC	±0.4% rdg.±0.2%f.s.														
10 Hz ≤ f < 30 Hz	±0.4% rdg.±0.2%f.s.														
30 Hz ≤ f ≤ 400 Hz	±0.3% rdg.±0.1%f.s.														
400 Hz < f ≤ 1 kHz	±0.4% rdg.±0.2%f.s.														
1 kHz < f ≤ 5 kHz	±1.0% rdg.±0.5%f.s.														
5 kHz < f ≤ 8 kHz	±4.0% rdg.±1.0%f.s.														

D/A Output Specifications (PW3335-02 and PW3335-04)

Number of output channels	7 channels
Configuration	16-bit D/A converter (polarity + 15 bits)
Output voltage	The output level, output speed, and waveform output can be selected. Level output 2 Vf.s. or 5 Vf.s., linked to display updates High-speed level output 2 Vf.s. or 5 Vf.s., linked to synchronization interval Waveform output 1 Vf.s., linked to sampling
Output parameters	Output parameters for all channels Available selections vary with the output parameter. Level output/ High-speed level output/ Waveform output Voltage, current, active power Only Level output Apparent power, reactive power, power factor, phase angle, total harmonic voltage distortion, total harmonic current distortion, voltage ripple rate, current ripple rate, voltage crest factor, current crest factor, time average current, time average active power, maximum current ratio Only Level output 5 Vf.s. Frequency, current integration, active power integration The rectifier can be selected. Harmonic-order output is not supported.

Output accuracy	f.s.: Relative to the output voltage rated value for each output parameter Level output (Output parameter measurement accuracy) + (±0.2%f.s.) High-speed level output (Output parameter measurement accuracy) + (±0.2%f.s.) Waveform output (Output parameter measurement accuracy) + (±1.0%f.s.)
Output frequency band	Waveform output, high-speed level output At DC or 10 Hz to 30 kHz, accuracy is as defined above.
Maximum output voltage	Approx. ±12 V DC
Output update rate	Level output Same as the data update period. High-speed level output AC Updated once every cycle for the input waveform set as the synchronization source. However, voltage and current are only updated once every cycle for input signals from 45 to 66 Hz. Waveform output Approx. 1.43 μs (approx. 700 kHz)
Response time	Level output 0.6 sec. or less High-speed level output 2 ms or less Waveform output 0.2 ms or less
Temperature coefficient	±0.05%f.s./°C or less
Output resistance	Approx. 100 Ω

External control

Functions	Integration start/stop, integration reset and hold via external control
Input signal level	0 to 5 V (high-speed CMOS level) or shorted [Lo]/ open [Hi]

GP-IB interface (PW3335-01 and PW3335-04)

Method	Compliant with IEEE488.1 1987, in reference to IEEE488.2 1987 Interface functions SH1, AH1, T6, L4, SR1, RL1, PP0, DC1, DT1, C0
Address	00 to 30

RS-232C interface (PW3335, PW3335-02, PW3335-03, and PW3335-04)

Connector	D-sub 9-pin connector × 1
Communication method	Full duplex, Start-stop synchronization Stop bits: 1 (fixed) Data length: 8 (fixed) Parity: None
Communication speed	9600 bps/ 38400 bps

LAN interface

Connector	RJ-45 connector × 1
Electrical specifications	Compliant with IEEE802.3
Transmission method	10Base-T/ 100Base-TX (automatic detection)
Protocol	TCP/ IP
Functions	HTTP server (remote operation, firmware updates) Dedicated ports (command control, data transfer) Remote control by controller

General Specifications

Product warranty period	3 year
Operating environment	Indoors, altitude up to 2000 m (6562 ft.), pollution degree 2
Operating temperature and humidity	0°C to 40°C (32°F to 104°F), 80% RH or less (no condensation)
Storage temperature and humidity	-10°C to 50°C (14°F to 122°F), 80% RH or less (no condensation)
Dielectric strength	4290 V rms AC (current sensitivity: 1 mA) Between the voltage input terminals and a connection consisting of chassis, interfaces, and output terminals Between the current input terminals and a connection consisting of chassis, interfaces, and output terminals Between the voltage input terminals and current input terminals
Maximum rated voltage to earth	Voltage input terminal, Current input terminal Measurement category III 600 V (anticipated transient overvoltage: 6000 V) Measurement category II 1000 V (anticipated transient overvoltage: 6000 V)
Maximum input voltage	Between the voltage input terminals U and ±1000 V, ±1500 V peak
Maximum input current	Between the current input terminals I and ±200 mA to 20 A range 30 A, ±100 A peak 1 mA to 100 mA range 20 A, ±30 A peak
Applicable Standards	Safety EN61010 EMC EN61326 Class A EN61000-3-2 EN61000-3-3
Rated supply voltage	100 V AC to 240 V AC 50 Hz/60 Hz
Maximum rated power	30 VA or less
Dimensions	Approx. 210W × 100H × 245D mm (8.27"W × 3.94"H × 9.65"D) (excluding protrusions)
Mass	Approx. 3 kg (105.8 oz.)
Accessories	Instruction manual ×1 Power cord ×1 Voltage and current input terminal safety cover ×2

3334 Specifications

Basic Specifications

Measurable lines	Single-phase, 2-wire (AC/DC)						
Measurement parameters	Voltage, current, active power, apparent power, power factor, frequency, integrated current and active power, waveform peak (voltage and current)						
Measurement method	Simultaneous digital sampling of voltage and current, True RMS						
Sampling Frequency	Approx. 74.4kHz						
Measurement Ranges	Current	100.00 mA	300.0 mA	1.0000 A	3.000 A	10.000 A	30.00 A
	Voltage	15.000 V	4.500 V	15.000 V	45.00 V	150.00 V	450.0 V
	Power	1.5000 W	4.500 W	15.000 W	45.00 W	150.00 W	450.0 W
	Power	3.000 W	9.000 W	30.00 W	90.00 W	300.0 W	900.0 W
	Power	15.000 W	45.00 W	150.00 W	450.0 W	1.5000 kW	4.500 kW
Power	30.00 V	30.00 W	90.00 W	300.0 W	900.0 W	3.000 kW	9.000 kW
Frequency bandwidth	DC, 45Hz to 5kHz						

Measurement accuracy

(Guaranteed at 23°C±5, max. 80%/rh, sine wave input, power factor=1, in-phase voltage =0V, accuracy specifications differ depending on usage period of 1 or 3 years)

Warm-up time	3 minutes		
Period of guaranteed accuracy	3 years (better accuracy specifications available for 1-year period)		
Effective measurement range	Voltage, current: 1% to 100% (Power: 0% to 100%) Measurements below 0.5% of the voltage or current range will be zero suppressed.		
Effect of power factor (at pf=0.5)	Maximum ±0.4%±rdg. (45 to 66Hz)		
Temperature Coefficient	Maximum ±0.03%f.s./°C		
Frequency	Guaranteed Period	Voltage, current and active power (at less than 50% of input range)	Current and active power (at 50% to 100% of input range)
	DC *	1 year ±0.1 %rdg. ±0.2 %f.s. 3 years ±0.1 %rdg. ±0.35 %f.s.	±0.2 %rdg. ±0.3 %f.s.
45 Hz ≤ f ≤ 66 Hz	1 year	±0.1 %rdg. ±0.1 %f.s.	±0.2 %rdg. ±0.3 %f.s.
	3 years	±0.1 %rdg. ±0.2 %f.s.	±0.3 %rdg. ±0.4 %f.s.
66 Hz < f ≤ 1 kHz **	1 year	±0.1 %rdg. ±0.2 %f.s.	±0.3 %rdg. ±0.4 %f.s.
	3 years	±0.1 %rdg. ±0.35 %f.s.	±0.45 %rdg. ±0.5 %f.s.
1 kHz < f ≤ 5 kHz **	1 year	±3.0 %f.s.	±3.0 %rdg. ±4.5 %f.s.
	3 years	±4.5 %f.s.	±4.5 %rdg. ±6.0 %f.s.

*Add ±50µA to the accuracy when measuring DC current
Add (±50µA x voltage value) to the accuracy when measuring DC active power
** Accuracy not defined for current input exceeding 20A

Input Specifications

Input impedance	2.4 MΩ for voltage, 10 mΩ or better (50/ 60 Hz) for current
Maximum input voltage	300 V, ±425 Vpeak
Maximum input current	30 A, ±54.0 Apeak
Maximum effective peak voltage	±300% of each voltage range, Within ±425 Vpeak
Maximum effective peak current	±300% of each current range, Within ±54.0 Apeak *1
Max. rated voltage to earth	300 V (DC, 50/ 60 Hz)

Display Specifications

Display indication range	Voltage and current: 0.5% to 105% of range Active power: 0% to 110.25% of range
Displacement power factor	0.000 to 1.000 (no polarity display)
Display refresh rate	approx. 5 times per second
Response time	within 0.5 s (Time to rated accuracy after abrupt change in input [0 to 90% or 100 to 10% of range])

Functional Specifications

Integration measurement	No. of displayed digits:	Six digits
	Current Integration:	From 0.00000mAh, Polarity-independent integration and Sum value
	Active power Integration:	From 0.00000mWh, Polarity-independent integration and Sum value
Wave peak measurement	Integration time:	1 min to 10000 h
	Measurement accuracy:	Measurement accuracy of active power ±1dgt.
Rectification method	Switchable between AC+DC(True RMS), DC(simple average display) and AC(True RMS)	
Analog output (D/A output)	Parameter output representation: Voltage, Current and Active power (3 simultaneous channels) D/A select an item from Current integration, Active power integration, Apparent power, power factor Voltage output: ±2 VDC f.s. for each range Output accuracy: ±0.5% f.s. + individual measurement accuracy	
Waveform output	Parameter output representation: Voltage, Current and Active power (3 simultaneous channels) Voltage output: 1 VDC f.s. for each range Output accuracy: ±1.0% f.s. + individual measurement accuracy	
Average function	Simple averaging of specified number of samples: 1, 2, 5, 10, 25, 50 or 100	
VT or CT ratio	VT ratios: 1, 2, 4, 10, 20, 30, 60, 100 CT ratios: 1, 2, 3, 4, 5, 6, 8, 10, 12, 15, 16, 20, 24, 25, 30, 40, 50, 60, 75, 80, 100, 200, 300, 500, 1000, 2000, 3000, 5000, 10000	
External Interfaces	RS-232C interface: Included as standard Asynchronous communication method: full-duplex; Baud rate: 9600 bps (fixed) GP-IB interface (Model 3334-01 only) IEEE-488.1 1987 compliant, IEEE-488.2 1987 reference	
Miscellaneous	Display hold, Maximum value hold, Peak value hold, Key lock, Backup function (preserves settings, integration data)	

General Specifications

Safety	EN61010 Pollution Factor 2, Measurement Category III (4000 V anticipated overvoltage)
EMC	EN61326, EN61000-3-2, EN61000-3-3
Operating environment	0 to 40 °C, 80% RH or less, non-condensating
Storage environment	-10 to 50 °C, 80% RH or less, non-condensating
Rated supply voltage	100 to 240 VAC, 50/60 Hz
Maximum rated power	20 VA
Dimensions and mass	210 mm (8.27 in)W x 100 mm (3.94 in)H x 245 mm (9.65 in)D (excluding feet and projections), 2.5 kg (88.2 oz)

3333 Specifications

Basic specifications

Measurable lines	Single-phase, 2-wire (AC)						
Measurement parameters	Voltage, Current, Active power, Apparent power, Power factor						
Measurement method	Simultaneous digital sampling of voltage and current, True RMS						
Sampling frequency	Approx. 48kHz						
Measurement ranges	Current	50.00 mA	200.0 mA	500.0 mA	2.000 A	5.000 A	20.00 A
	Voltage	10.000 V	40.00 W	100.00 W	400.0 W	1.0000 kW	4.000 kW
Frequency bandwidth	45Hz to 5kHz						

Measurement accuracy

(Guaranteed at 23°C±5, max. 80%/rh, sine wave input, power factor=1, in-phase voltage =0V, accuracy specifications differ depending on usage period of 1 or 3 years)

Warm-up time	10 minutes	
Period of guaranteed accuracy	3 years (better accuracy specifications available for 1-year period)	
Effective measurement range	Voltage, current, power: 10% to 150% Measurements below 1% of the voltage or current range will be zero suppressed.	
Effect of power factor (at pf=0.5)	Maximum ±0.4%±rdg. (45 to 66Hz)	
Temperature Coefficient	Maximum ±0.03%f.s./°C	
Frequency	Guaranteed Period	Voltage, current and active power
	45 Hz ≤ f ≤ 66 Hz	1 year ±0.1 %rdg. ±0.1 %f.s. 3 years ±0.1 %rdg. ±0.2 %f.s.
66 Hz < f ≤ 1 kHz *	1 year	±0.1 %rdg. ±0.2 %f.s.
	3 years	±0.1 %rdg. ±0.35 %f.s.
1 kHz < f ≤ 5 kHz *	1 year	±3.0 %f.s.
	3 years	±4.5 %f.s.

* Accuracy not defined for current input exceeding 20A

Input specifications

Input impedance	2.4 MΩ for voltage, 7 mΩ or better (50/60 Hz) for current
Maximum input voltage	300 Vrms, 425 Vpeak
Maximum input current	30 Arms, 42.5 Apeak
Maximum effective peak voltage	Within 425Vpeak
Maximum effective peak current	±300% of each current range, Within ±42.5Apeak
Max. rated voltage to earth	300V (50/60Hz)

Display specifications

Display indication range	voltage and current: 1% to 152% of range active power: 0% to 231.04% of range
Displacement power factor	0.000 to 1.000 (no polarity display)
Display refresh rate	approx. 5 times per second
Response time	within 0.5 s (Time to rated accuracy after abrupt change in input [0 to 90% or 100 to 10% of range])

Functional Specifications

Rectification method	AC(True RMS)
Analog output (D/A output)	Parameter output representation: voltage, current and active power (3 simultaneous channels) Voltage output: +2 VDC f.s. for each range Output accuracy: ±0.5% f.s. + individual measurement accuracy
Average function	Simple averaging of specified number of samples: 1, 2, 5, 10, 25, 50 or 100
VT or CT ratio	VT ratios: 1, 2, 4, 10, 20, 30, 60, 100 CT ratios: 1, 2, 3, 4, 5, 6, 8, 10, 12, 15, 16, 20, 24, 25, 30, 40, 50, 60, 75, 80, 100
External Interfaces	RS-232C interface: Included as standard Asynchronous communication method: full-duplex; Baud rate: 9600 bps (fixed) GP-IB interface (Model 3333-01 only) IEEE-488.1 1987 compliant, IEEE-488.2 1987 reference
Miscellaneous	Display hold, Key lock, Settings backup (preserves settings)

General Specifications

Safety	EN61010 Pollution Factor 2, Measurement Category III (4000 V anticipated overvoltage)
EMC	EN61326, EN61000-3-2, EN61000-3-3
Operating environment	0 to 40 °C, 80% RH or less, non-condensating
Storage environment	-10 to 50 °C, 80% RH or less, non-condensating
Rated supply voltage	100 to 240 VAC, 50/60 Hz
Maximum rated power	20 VA
Dimensions and mass	160 mm (6.30 in)W x 100 mm (3.94 in)H x 227 mm (8.94 in)D (excluding feet and projections), 1.9 kg (67.0 oz)

Calculation formulas (3333 & 3334)

Measurement Parameters	Formula
Apparent Power (S)	$S = U \times I$
Power Factor (λ)	$\lambda = P / S$
Integrated Current*	(Sum of I from start of integration) / (Number of 1 hour data)
Integrated Active Power *	(Sum of P from start of integration) / (Number of 1 hour data)

* Current and active power integration available only on Model 3334.

3-phase Power Meter

Model & Appearance	Model No. (Order Code)	Number of Channels	AC/ DC	Harmonic Measurement	LAN	RS-232C	GP-IB	D/A output	Current Sensor Input	Synchronized Control
	PW3337	3	AC/ DC	✓	✓	✓	×	×	✓	✓
	PW3337-01	3	AC/ DC	✓	✓	✓	✓	×	✓	✓
	PW3337-02	3	AC/ DC	✓	✓	✓	×	✓	✓	✓
	PW3337-03	3	AC/ DC	✓	✓	✓	✓	✓	✓	✓
	PW3336	2	AC/ DC	✓	✓	✓	×	×	✓	✓
	PW3336-01	2	AC/ DC	✓	✓	✓	✓	×	✓	✓
	PW3336-02	2	AC/ DC	✓	✓	✓	×	✓	✓	✓
	PW3336-03	2	AC/ DC	✓	✓	✓	✓	✓	✓	✓

Accessories: Instruction manual x1, Measurement guide x1, Power cord x1

Single-phase Power Meter

Model & Appearance	Model No. (Order Code)	Number of Channels	AC/ DC	Harmonic Measurement	LAN	RS-232C	GP-IB	D/A output	Current Sensor Input	Synchronized Control
	PW3335	1	AC/ DC	✓	✓	✓	×	×	×	✓
	PW3335-01	1	AC/ DC	✓	✓	×	✓	×	×	✓
	PW3335-02	1	AC/ DC	✓	✓	✓	×	✓	×	✓
	PW3335-03	1	AC/ DC	✓	✓	✓	×	×	✓	✓
	PW3335-04	1	AC/ DC	✓	✓	✓	✓	✓	✓	✓
	3334	1	AC/ DC	×	×	✓	×	✓	×	×
	3334-01	1	AC/ DC	×	×	✓	✓	✓	×	×
	3333	1	AC	×	×	✓	×	✓	×	×
	3333-01	1	AC	×	×	✓	✓	✓	×	×

Accessories : Instruction manual x1, Power cord x1

Communications and control options



RS-232C CABLE
9637
Cable length: 1.8 m (5.91 ft)
9pin to 9pin



GP-IB CONNECTOR
CABLE 9151-02
Cable length: 2 m (6.56 ft)



LAN CABLE
9642
Cable length: 5 m (16.41 ft)
supplied with straight to
cross conversion cable



CONNECTION CORD
9165
For synchronized control
Cable length: 1.5 m (4.92 ft),
metal BNC to metal BNC

Note: Company names and product names appearing in this brochure are trademarks or registered trademarks of various companies.

HIOKI

HIOKI E. E. CORPORATION

DISTRIBUTED BY

HEADQUARTERS

81 Koizumi,
Ueda, Nagano 386-1192 Japan
<https://www.hioki.com/>



Scan for all
regional contact
information