



SM7420

Instruction Manual

SUPER MEGOHM METER



 Be sure to read this manual before using the instrument.		▶ p.7, p.8
 When using the instrument for the first time	Names and Functions of Parts	▶ p.16
	Preparing for Measurement	▶ p.27
 Troubleshooting	Maintenance and Service	▶ p.133
	Error display and solution	▶ p.136

EN



Contents

Introduction.....	1	3.7	Confirming Measurement Results	39
Notation	1		Detecting a measurement abnormality	39
Verifying Package Contents	3		Temperature measurement indication	39
Measurement Procedure	6		Out-of-range indication	39
Safety Information	7	3.8	Basic Measurement Examples.....	40
Operating Precautions.....	8			
1 Overview	15	4	Applied Measurement	43
1.1 Product Overview and Features.....	15	4.1	Starting Measurement After	
1.2 Names and Functions of Parts.....	16		Measured Value Becomes Stable	
1.3 Screen Configuration and Operation	21		(Delay Function).....	43
Measurement screens	21	4.2	Reducing Variation in Measured	
Settings screens	22		Values (Average Function)	44
1.4 Basic Key Operation	23	4.3	Changing Measurement Starting	
Displaying measurement screen	23		Conditions (Trigger Function).....	46
Displaying the various menu settings			Setting the trigger mode	46
screens	23		Inputting an external trigger	46
Selecting settings items	24	4.4	Maintaining Measurement	
Methods for changing numerical values	25		Accuracy (Self-Calibration Function)	47
		4.5	Contact Check (Various Settings)	49
		4.6	Canceling Capacitance of	
			Measurement Fixture (Fixture	
			Capacitance Open Correction	
			Function)	52
		4.7	Contact Check (Executing Contact	
			Check, Setting Reference Value)	53
		4.8	Setting Resistivity Calculation	
			(Resistivity Measurement Function) .	55
		4.9	Further Accelerating Measurement	
			(Function of Updating Drawing	
			During Measurement)	58
		5	Measurement Methods	
			Suitable for Various	
			Objects to Be Measured	59
		5.1	Measuring Components of Circuits ..	59
			Measurement with use of a	
			measurement fixture	60
			Measurement without use of a	
			measurement fixture	61
			Automatic measurement.....	62
		5.2	Measuring Flat Sample	63
			Measurement using pin type terminals	63
			Measurement using an electrode for	
			measuring surface resistance.....	63
			Measurement using an electrode for a	
			flat sample	64
			Volume resistance measurement and	
			surface resistivity measurement (the	
			functional role of the guard electrode)	64

5.3	Measuring a Liquid Sample.....	66
	When using an electrode for liquid samples	66
5.4	Measurement With Use of Shielding Box	67
5.5	Measuring Current	68

6 Judging Measured Value (Comparator Function) 69

6.1	Setting Judgment Sound.....	71
6.2	Confirming Judgment Results	72

7 Saving and Loading Settings (Panel Saving and Loading) 73

7.1	Saving Settings (Panel Saving Function)	74
7.2	Loading Settings (Panel Loading Function)	75
7.3	Changing Panel Name	76
7.4	Deleting Panel Contents	77

8 System Setting 79

8.1	Setting Sound of Key Operation.....	79
8.2	Disabling Key Operation (Key Lock Function).....	80
8.3	Browsing, Deleting, and Outputting Internal Memory Data.....	81
	Browsing and deleting data	82
8.4	Setting D/A Output	83
8.5	Adjusting Screen Contrast	84
8.6	Adjusting Backlight Brightness.....	84
8.7	Changing Power Frequency Setting (Power Frequency Setting Function)	85
8.8	Initializing Settings (Reset).....	86
	Default setting list	87
8.9	Checking Instrument Information	88

9 External Control (EXT I/O) 89

9.1	Switching Current Sink (NPN) / Current Source (PNP).....	90
-----	--	----

9.2	External Input/Output Terminals and Signals	90
	Instrument-side connector and mating connectors	90
	Instrument-side connector pin assignment	91
	Functions of each of the signals	93
9.3	Timing Chart.....	94
	From when measurement starts to when judgment result is acquired	94
	Output signal status on start-up.....	97
	Flowchart for acquiring a judgment result or a measured value with the external trigger setting	97
9.4	Internal Circuit Configuration.....	98
	Electrical Specifications	99
	Examples of connection.....	100
9.5	Assembling Male Connector for EXT I/O (Accessory).....	102
9.6	EXT I/O Terminal Input and Output Testing.....	103
9.7	Settings for External Input and Output	104
	Trigger logic	104
	Trigger filter.....	105
	GO-signal outputting logic level	106
	EOM signal output mode	107

10 Communications (USB, RS-232C, GP-IB) 109

10.1	Summary and Features of Interface	109
10.2	USB Interface.....	110
	Installing the USB driver	110
	Connecting the USB cable.....	110
	Setting the instrument.....	111
10.3	RS-232C Interface	112
	Connecting the RS-232C cable	112
	Setting the instrument.....	113
	Setting the controller (Computer or PLC)	113
10.4	GP-IB Interface	114
	Connecting the GP-IB cable	114
	Setting the instrument.....	114
10.5	Settings Common to Interfaces.....	116
	Outputting measured values (data output function)	
	(RS-232C and USB only).....	116
	Displaying communication commands (communication monitor function).....	117
10.6	Control by Using Commands	118
	Remote state	118
	Local state	118

11 Specifications 119

- 11.1 General Specifications 119
- 11.2 Input/Output/Measurement Specifications 120
 - Basic specifications 120
 - Accuracy specifications 121
- 11.3 Function specifications 124
- 11.4 Interface Specifications 130
- 11.5 External I/O Specifications 131

12 Maintenance and Service 133

- 12.1 Troubleshooting 133
 - Q&A (Frequently Asked Questions) 133
 - Error display and solution 136
- 12.2 Calibrations, Replaceable Parts, Cleaning, and Disposal 138

Appendix Appx.1

- Appx. 1 Internal Circuits Appx.1
- Appx. 2 Changes in Current Running through Insulator .. Appx.2
- Appx. 3 Countermeasures Against Noise Appx.3
- Appx. 4 Using Instrument with 2000 V or Higher Voltage Applied (With External Power Supply) Appx.6
- Appx. 5 Assembling Switching Unit for Object to Be Measured.. Appx.7
 - Connecting objects to be measured and the switching unit to the instrument Appx.7
 - Selecting relays to be installed in the switching unit..... Appx.8
 - Circuit diagram of the switching unit Appx.9
 - Including current-limiting resistor (protective resistance) and relay .. Appx.9
 - Current-limiting resistor Appx.10
- Appx. 6 Modifying Measurement Lead Appx.11
- Appx. 7 Mounting Instrument in Rack Appx.14
- Appx. 8 Dimensional Diagram Appx.16

Index Ind.1

11

12

5

6

7

8

9

10

Appx.

Ind.

Introduction

Thank you for purchasing the Hioki SM7420 Super Megohm Meter. To obtain maximum performance from the instrument, please read this manual first, and keep it handy for future reference.

Following manuals are provided along with these models. Refer to manuals relevant to your purpose.

Type	Contents	Printed	CD-stored File name
Instruction Manual (This document)	Operating instructions, functions, specifications, etc.	✓	–
Communications Command Instruction Manual	Explanation of communications (including message references and measured value formats)	–	✓ SM7420A964-XX

Target audience

This manual has been written for use by individuals who use the product in question or who teach others to do so. It is assumed that the reader possesses basic electrical knowledge (equivalent to that of someone who graduated from the electrical program at a technical high school).







Trademark

- Microsoft and Windows are either registered trademarks or trademarks of Microsoft Corporation in the United States and other countries.
- TEFLON is a registered trademark or a trademark of The Chemours Company FC, LLC.







Notation

Concerning Safety



In this manual, the risk seriousness and the hazard levels are classified as follows.

 DANGER	Indicates an imminently hazardous situation that will result in death or serious injury to the operator.
 WARNING	Indicates a potentially hazardous situation that may result in death or serious injury to the operator.
 CAUTION	Indicates a potentially hazardous situation that may result in minor or moderate injury to the operator or damage to the instrument or malfunction.
IMPORTANT	Indicates information related to the operation of the instrument or maintenance tasks with which the operators must be fully familiar.
	Indicates a high voltage hazard. If a particular safety check is not performed or the instrument is mishandled, this may give rise to a hazardous situation; the operator may receive an electric shock, may get burnt or may even be fatally injured.
	Indicates prohibited actions.
	Indicates the action which must be performed.

Symbols on the instrument

	Indicates cautions and hazards. When the symbol is printed on the instrument, refer to a corresponding topic in the Instruction Manual.
	Indicates the ON side of the power switch.
	Indicates the OFF side of the power switch.
	Indicates a grounding terminal.
	Indicates DC (Direct Current).
	Indicates AC (Alternating Current).

Symbols for various standards

	Indicates the Waste Electrical and Electronic Equipment Directive (WEEE Directive) in EU member states.
	Indicates that the product conforms to regulations set out by the EU Directive.

Others

*	Additional information is presented below.
SET (Bold character)	Operation keys are displayed in bold.
[]	Names on the screen are indicated with brackets [].

Accuracy

We define measurement tolerances in terms of f.s. (full scale), rdg. (reading), and dgt. (digit) values with the following meanings:

f.s.	(maximum display value or scale range) The currently selected range.
rdg.	(reading or displayed value) The value currently being measured and indicated on the measuring instrument.
dgt.	(resolution) The smallest displayable unit on a digital measuring instrument, i.e., the input value that causes the digital display to show a "1" as the least-significant digit.

Verifying Package Contents

When you receive the instrument, inspect it carefully to ensure that no damage occurred during shipping. In particular, check the accessories, panel switches, keys, and connectors. If damage is evident, or if it fails to operate according to the specifications, contact your authorized Hioki distributor or reseller.

Main unit and accessories

Confirm that these contents are provided.

- Model SM7420 Super Megohm Meter

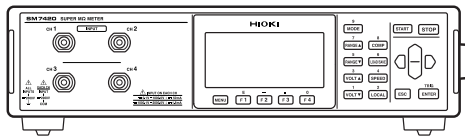

- Instruction Manual



- Male connector for EXT I/O

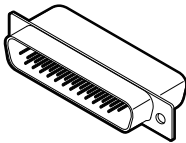

- Power cord

- CD (Communications Command Instruction Manual, USB driver)*



* The latest version can be downloaded from our website.

Options

The following options are available for the instrument. Contact your authorized Hioki distributor or reseller when ordering. Options are subject to change. Please check Hioki's website for the latest information.

Measurement leads

 See p. 10.

Model L2230 Pin Type Lead (Red)

Length: 1 m
Terminal shape: Triaxial BNC
Maximum rated voltage: 2000 V
Maximum rated current: 1 A



Model L2231 Pin Type Lead (Black)

Length: 1 m
Terminal shape: Banana
Maximum rated voltage: 2000 V
Maximum rated current: 1 A



Model L2232 Clip Type Lead (Red)

Length: 1 m
Terminal shape: Triaxial BNC
Maximum rated voltage: 2000 V
Maximum rated current: 1 A



Model L2233 Clip Type Lead (Black)

Length: 1 m
Terminal shape: Banana
Maximum rated voltage: 2000 V
Maximum rated current: 1 A



Model L2234 Open Lead (Red)

Length: 3 m
Terminal shape: Triaxial BNC
Maximum rated voltage: 2000 V
Maximum rated current: 1 A



Model L2235 Open Lead (Black)

Length: 3 m
Terminal shape: Banana
Maximum rated voltage: 2000 V
Maximum rated current: 1 A



Communication cables

Model 9637 RS-232C Cable (9pin-9pin/1.8 m)



Model 9638 RS-232C Cable (9pin-25pin/1.8 m)



Model 9151-02 GP-IB Connector Cable (2 m)



Electrodes

Conversion of the connectors is required to connect these electrodes. Contact your authorized Hioki distributor or reseller.

- Model SME-8301 Surface Resistance Measurement Electrode



- Model SME-8302 Electrode for Surface Resistance



- Model SME-8310 Plate Sample Electrode



- SME-8311 Electrode for Flat Sample

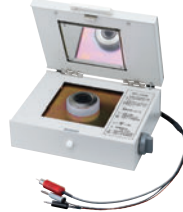

- Model SME-8320 Weight Electrode



- Model SME-8330 Liquid Sample Electrode



- Model SME-8350 Shielding Box



- Model SME-8360 Electrode for Chip Capacitor



- Model SM9001 Surface/Volume Resistance Measurement Electrode



- Model SR-2 Standard Resistor



Temperature and humidity sensor

- Model Z2011 Humidity Sensor



Measurement Procedure

Be sure to read “Operating Precautions” (p. 8) beforehand.

Installing, connecting, and turning on the instrument

Install the instrument. (p. 9)

Connect the power cord to the instrument. (p. 27)

Connect the measurement lead, electrode, and the Humidity Sensor to the instrument. (p. 28)

Connect other devices to the instrument via the external interface (as needed).

- Use the EXT I/O. (p. 90)
- Connect a computer to the instrument for communications through USB, RS-232C, or GP-IB. (p. 109)

Turn on the instrument. (p. 31)

(It takes at least 30 minutes to complete a warm-up.)

Connect the measurement lead and electrode to the instrument.

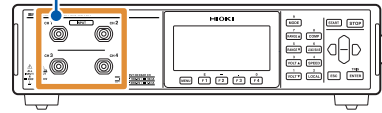

Turn on the instrument.

Connect the power cord to the instrument.

Connect the temperature and humidity sensor to the instrument.

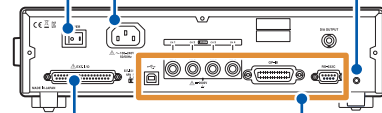

Use the EXT I/O.

Communicate with the computer through USB, RS-232C, or GP-IB.

Setting the instrument (p. 33)

Set the measurement conditions (as needed).

- Basic setting (p. 33)
- Customized setting for measurement conditions (p. 43)
- Setting related to the system (p. 79)
- Default setting table (p. 87)

Starting the measurement

Execute the open correction. (p. 52)

If contact check is set to ON, execute the open correction.

Connect the measurement lead to an object to be measured. (p. 38)

Start the measurement. (p. 39)

Check the measured values. (p. 39)

Press the STOP key to end the measurement. (p. 39)

If the trigger source setting is set to **[EXTERNAL]**, the measurement automatically stops on completion of each measurement.

Ending

Turn off the instrument. (p. 31)

Safety Information

This instrument is designed to conform to IEC61010 Safety Standards, and has been thoroughly tested for safety prior to shipment. However, using the instrument in a way not described in this manual may negate the provided safety features.

Before using the instrument, be certain to carefully read the following safety notes:

⚠ DANGER



Mishandling during use could result in injury or death, as well as damage to the instrument. Be certain that you understand the instructions and precautions in the manual before use.

⚠ WARNING



With regard to the electricity supply, there are risks of electric shock, heat generation, fire, and arc flash due to short circuits. If persons unfamiliar with electricity measuring instrument are to use the instrument, another person familiar with such instruments must supervise operations.

Measurement categories

To ensure safe operation of measuring instruments, IEC61010 establishes safety standards for various electrical environments, categorized as CAT II to CAT IV, and called measurement categories.

⚠ DANGER



- **Using a measuring instrument in an environment designated with a higher-numbered category than that for which the instrument is rated could result in a severe accident, and must be carefully avoided.**
- **Never use a measuring instrument that lacks category labeling in a CAT II to CAT IV measurement environment. Doing so could result in a serious accident.**

- CAT II: When directly measuring the electrical outlet receptacles of the primary electrical circuits in equipment connected to an AC electrical outlet by a power cord (portable tools, household appliances, etc.)
- CAT III: When measuring the primary electrical circuits of heavy equipment (fixed installations) connected directly to the distribution panel, and feeders from the distribution panel to outlets
- CAT IV: When measuring the circuit from the service drop to the service entrance, and to the power meter and primary overcurrent protection device (distribution panel)

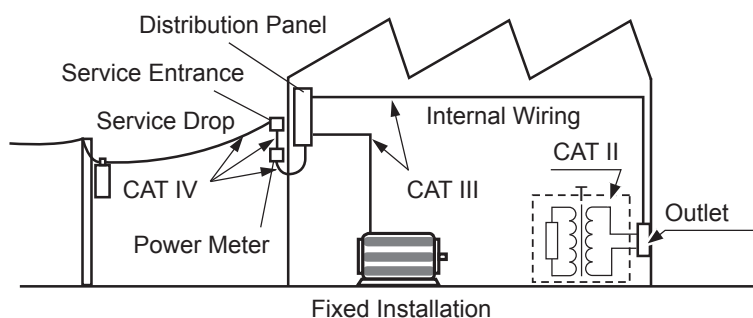

Operating Precautions

Follow these precautions to ensure safe operation and to obtain the full benefits of the various functions.

DANGER

If the measurement lead or the instrument is damaged, there is a risk of electric shock. Before using the instrument, perform the following inspection:



- Before using the instrument check that the coating of the measurement leads are neither ripped nor torn and that no metal parts are exposed. Using the instrument under such conditions could result in electric shock. Replace the measurement leads with those specified by our company.
- Verify that the instrument operates normally to ensure that no damage occurred during storage or shipping. If you find any damage, contact your authorized Hioki distributor or reseller.



To prevent an electric shock, confirm that the braided conductor for shielding wire is not exposed. If a braided conductor for shielding wire is exposed, do not use the cable.

Instrument installation

WARNING

Installing the instrument in inappropriate locations may cause a malfunction of instrument or may give rise to an accident. Avoid the following locations:



- Exposed to direct sunlight or high temperature
- Exposed to corrosive or combustible gases
- Exposed to a strong electromagnetic field or electrostatic charge
- Near induction heating systems (such as high-frequency induction heating systems and IH cooking equipment)
- Susceptible to vibration
- Exposed to water, oil, chemicals, or solvents
- Exposed to high humidity or condensation
- Exposed to high quantities of dust particles

CAUTION



Do not place the instrument on an unstable table or an inclined place. Dropping or knocking down the instrument can cause injury or damage to the instrument.



This instrument is not drip-proof. Water droplets on the connector may result in malfunctions.

Installing the instrument

To prevent overheating, be sure to leave the specified clearances around the instrument.

- Install with the bottom surface facing downward.
- Vents must not be obstructed.

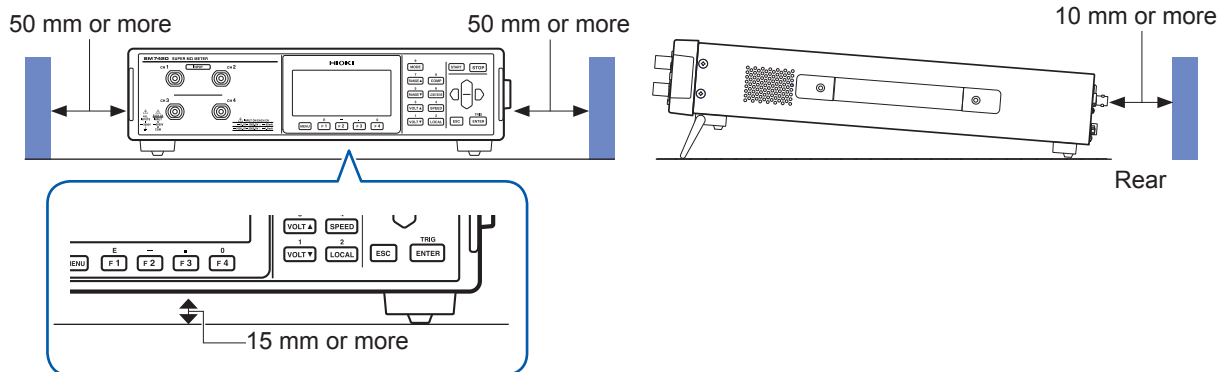

“Unfolding and retracting the stands” (p. 18)

Handling the instrument

DANGER



To avoid electric shock, do not remove the instrument's case. The internal components of the instrument carry high voltages and may become very hot during operation.

CAUTION



To avoid damage to the instrument, protect it from physical shock when transporting and handling. Be especially careful to avoid physical shock from dropping.

This instrument may cause interference if used in residential areas. Such use must be avoided unless the user takes special measures to reduce electromagnetic emissions to prevent interference to the reception of radio and television broadcasts.

Before connecting the power cord to the instrument

DANGER



Use only the designated power cord with this instrument. Use of other power cords may cause fire.

WARNING



- Before turning the instrument on, make sure the supply voltage matches that indicated on its power connector. Connection to an improper supply voltage may damage the instrument and present an electrical hazard.
- To avoid electrical accidents and to maintain the safety specifications of this instrument, connect the power cord provided only to an outlet.

CAUTION



- Do not connect the supply voltage improperly. Doing so may damage the instrument's internal circuitry.
- To avoid damaging the cords, unplug it by grasping the connector, not the cord.

Before connecting the measurement leads and electrode to the instrument

WARNING



- Do not use the instrument with circuits that exceed its ratings or specifications. Doing so may damage the instrument or cause it to become hot, resulting in electric shock.
- The maximum rated to-ground voltage of the input terminal is 2000 V DC. Do not apply any higher voltage input to the input terminal.



- Use only the specified measurement lead. If using a measurement lead other than the one specified, you cannot perform measurement safely.
- To avoid electric shock, do not exceed the lower of the ratings shown on the instrument and measurement leads.

Before connecting the Humidity Sensor to the instrument

CAUTION



- The sensor used in the Humidity Sensor is a thin, precision platinum film. Be aware that excessive voltage pulses or static discharges can destroy the film.
- Avoid subjecting the tip of the Humidity Sensor to physical shock, and avoid sharp bends in the leads. These may damage the probe or break a wire.
- Note that the ambient temperature does not exceed the temperature range specified in "Specifications of Model Z2011 Humidity Sensor" (p. 123).

Before performing a measurement

WARNING



- While measuring insulation resistance, dangerous voltage is applied to the measurement terminals. To avoid electric shock, do not touch the tip of the measurement leads.
- Even after the **STOP** key is pressed, the measurement voltage may remain in the measured object. Because there is a risk of an electric shock, take care to not touch metallic parts to which the voltage is applied until they are fully discharged.

CAUTION



To avoid malfunctions of the instrument, insert an adequate protective resistor between the external power supply and the object to be measured. A short-circuit of the terminals of the object causes the instrument to be subject to a voltage output from the external power supply.

- To avoid malfunctions of the instrument, limit the input current at up to 1.8 mA during the testing using a measurement voltage of between 1000 V and 2000 V.

See “Appx. 4 Using Instrument with 2000 V or Higher Voltage Applied (With External Power Supply)” (p. Appx.6).

Before performing an automatic measurement

CAUTION



To protect the relay contacts, switching the measurement terminals with relays leaving a measurement voltage output requires a protective resistor* inserted in series in the circuit.

Protective resistance value \geq (Measurement voltage) / (Maximum allowable current)

* Implements resistance to prevent the current flowing through the contact from exceeding the maximum allowable current of the contact

Before using the shielding box

WARNING



Be sure to connect the external case of the shielding box to the ground. In addition, take sufficient precautions to avoid an electric shock.

Before removing the measured object

WARNING



If a high-voltage is used to measure resistance, because measurement voltage may remain in the measured object even after the measurement has ended, there is the risk of an electric shock if you try to immediately remove the object. Remove the measured object after the dangerous voltage has been discharged.

Before controlling the instrument externally

WARNING

To avoid electric shock or damage to the equipment, always observe the following precautions when connecting to connectors:



- Be careful to avoid exceeding the ratings of connectors.
- During operation, a wire becoming dislocated and contacting another conductive object can be serious hazard. Use screws to secure the RS-232C connector, GP-IB connector, and EXT I/O terminal.
- Ensure that devices and systems to be connected to the RS-232C connector, GP-IB connector, or EXT I/O terminal are properly isolated.

CAUTION



You must not operate the EXT I/O MODE switch (NPN/PNP) while the instrument is turned on.



Select the external I/O mode between NPN and PNP based on devices that are externally connected (p. 90).

Before connecting the communication cable to the instrument

DANGER



To avoid electrical hazards and damage to the instrument, do not apply voltage exceeding the rated maximum to the EXT I/O terminal.

CAUTION



- Use a common ground for both the instrument and the computer. Use of different ground circuits will result in a potential difference between the instrument's ground and the computer's ground. If the communications cable is connected while such a potential difference exists, it may result in equipment malfunction or failure.
- Before connecting any communications cable to the instrument or disconnecting any communications cable from the instrument, always turn off the instrument and the computer. Failure to do so could result in equipment malfunction or damage.
- After connecting the communications cable, tighten the screws on the connector securely. Failure to secure the connector could result in equipment malfunction or damage.

Before performing the open correction

WARNING



If an open correction is carried out, a measurement voltage is instantly output from the measurement terminal.

Before carrying out an open correction (pressing the **F2** key [**EXEC**]), check that no human body is in contact with any jigs or measurement circuits.

Precautions during shipment

Store the packaging in which the instrument was delivered, as you will need it when transporting the instrument.

CD precautions

- Exercise care to keep the recorded side of discs free of dirt and scratches. When writing text on a disc's label, use a pen or marker with a soft tip.
- Keep discs inside a protective case and do not expose to direct sunlight, high temperature, or high humidity.
- Hioki is not liable for any issues your computer system experiences in the course of using this disc.

1.1 Product Overview and Features

This instrument is an insulation resistance meter containing a highly sensitive ammeter. Employing the triaxial BNC connector enables the instrument to measure high resistance such as resistance of insulators with no influence of exogenous noise. The maximum measurement voltage is 2000 V.

Stable measurements for a variety of items

- The triaxial BNC connector is used to have external noise resistant structures.
- The maximum measurement voltage is 2000 V, so various objects can be simply measured with a single instrument.
- The instrument has a wide measuring range. (Depends on applied voltage)
- Resistance measuring range: 50Ω to $2 \times 10^{19} \Omega$; Current measuring range: 0.1 fA to 2 mA
- Because temperature and humidity can be measured simultaneously, change in resistance can be checked with the change in temperature and humidity.
- The contact check function enables you to perform stable measurements.

Suitable for production lines

- High-speed measurement; it takes only 6.4 ms from input of a trigger to output of the INDEX signal.
- The frequency change function of contact check reduces interference with other devices in the production line.
- It is not necessary to correct cable length even when changing production line construction because the instrument automatically corrects the cable length of contact check.
- Because you can check the control status with the command monitor function and the external I/O monitor function, you can quickly construct a production line.
- Because the external I/O is compatible with both NPN and PNP types, you can immediately use it on your production line.

What can be measured

- Insulation resistance between capacitor terminals
- Insulation resistance between a battery terminal and a case
- Insulation resistance between coils of common mode filters
- Checking breakdown voltage
- Surface resistivity and volume resistivity of film, etc.
- Insulation resistance of liquid sample

1.2 Names and Functions of Parts

Front

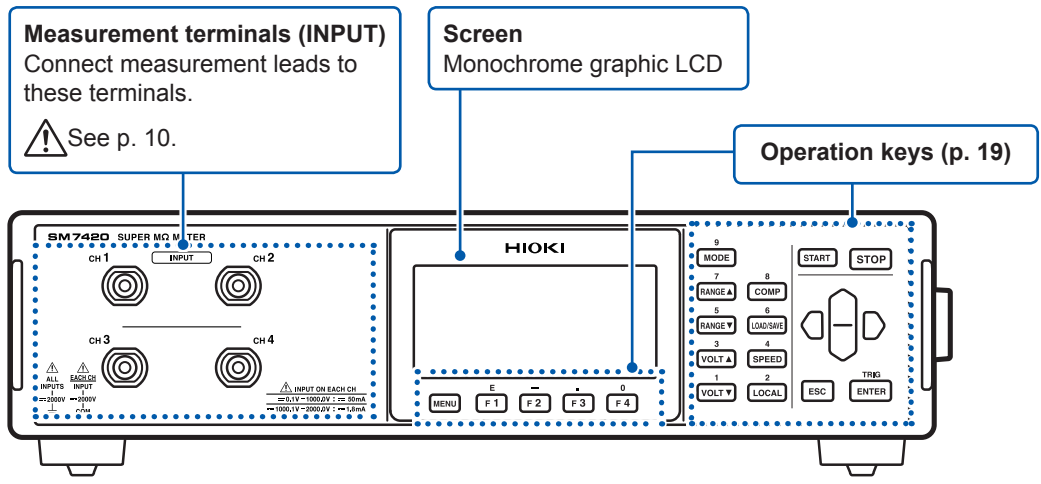

Measurement terminals	Description
<p>INPUT</p> 	<p>These are measurement input terminals. Have triaxial structure. The central conductor is for measurement input. The outermost electrode is connected to the GROUND potential of the measurement circuit. The second-outermost electrode is connected to the ground (case metal part).</p> <p>Additionally installing the shield wires in the measurement line enables the instrument to perform stable measurement with no influence of exogenous noise.</p>

Rear

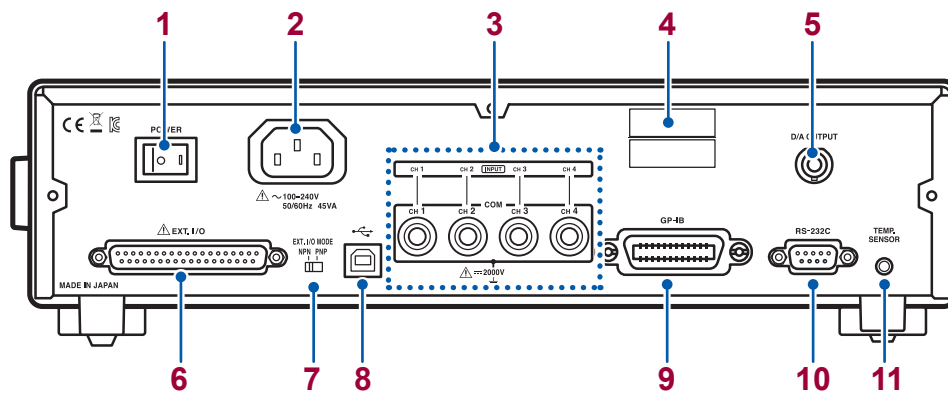

1

Overview

No.	Name	Description	Reference
1	Power switch	Turn on and off the instrument, flipping this switch.	p. 31
2	Power inlet	Connects the accessory power cord to this inlet.	⚠ p. 10 p. 27
3	COM terminals	These terminals are used to share the GROUND potential of the measurement circuit of the instrument and the external power supply. Connect these terminals to the COM or the GND terminal of the external power supply. If the GND terminal of the external power supply is shared by 4 channels, connect the COM1 terminal of instrument to the GND terminal of the external power supply.	⚠ p. 10
4	Serial number	Indicates the serial number. The serial number consists of 9 digits. The first two (from the left) indicate the year of manufacture, and the next two indicate the month of manufacture. Do not remove this label because it is required for product support.	—
5	D/A OUTPUT terminal	Outputs a voltage proportional to the measured value.	p. 30
6	EXT I/O terminal	Connects an external controller to this connector.	⚠ p. 12 p. 89
7	EXT I/O MODE switch	Left: Current sink (NPN), Right: Current source (PNP)	p. 90
8	USB connector		
9	GP-IB connector	Connects a computer to one of these connectors.	p. 109
10	RS-232C connector		
11	TEMP. SENSOR terminal	Connects Model Z2011 Humidity Sensor to this terminal.	p. 29

Bottom

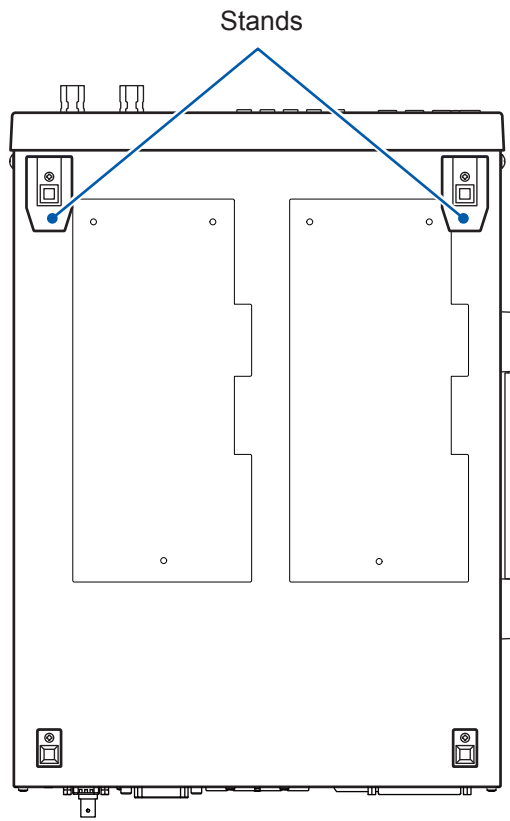

Right

Unfolding and retracting the stands

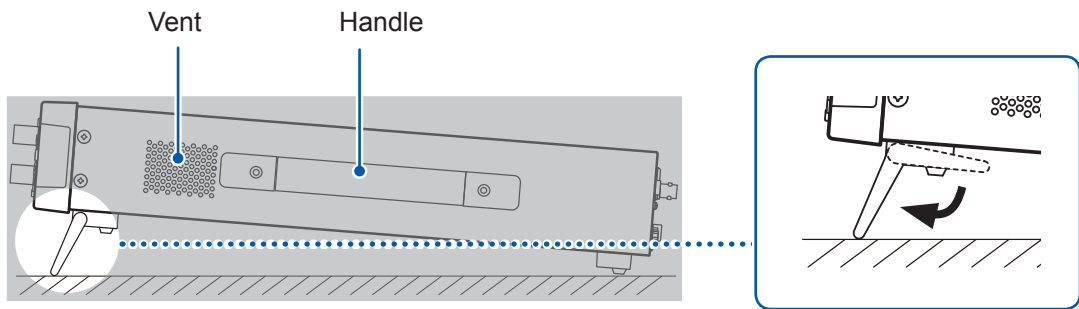

⚠ CAUTION



Do not apply heavy downward pressure with the stand extended. The stand could be damaged.



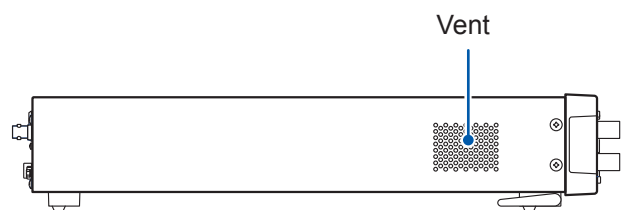

Left

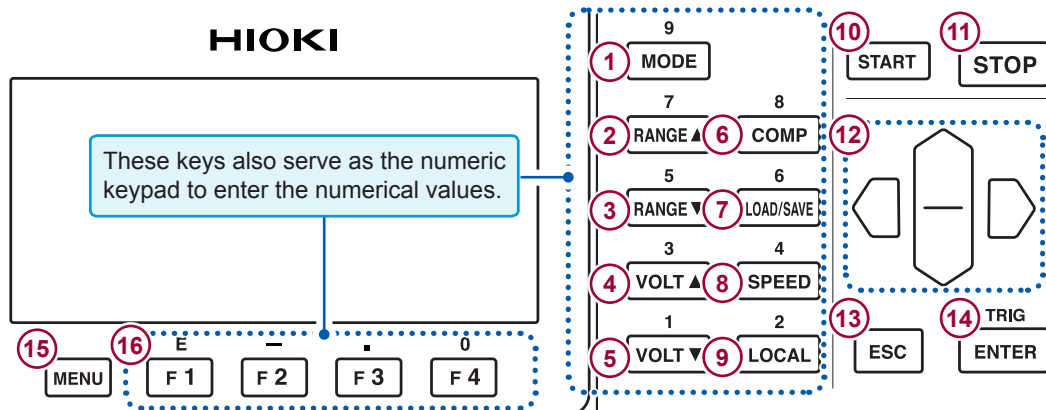

Operation keys

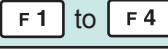

No.	Key	Description	Reference
1	MODE	Switches the measurement mode. The mode changes every time the key is pressed in the following order: Resistance, Current, Surface resistance, Volume resistance, Liquid volume resistance, and returns back to Resistance.	p. 33
2	RANGE ▲	Switches the present current range to the next upper one. You can change settings on the measurement screen. The mode changes every time the key is pressed in the following order: 20 p, 200 p, 2 n, 20 n, 200 n, 2 u, 20 u, 200 u, and 2 m. Some ranges are not available depending on the measurement speed setting.	p. 37
3	RANGE ▼	Switches the present current range to the next lower one. You can change settings on the measurement screen. The range changes every time the key is pressed in the reverse order of the above.	
4	VOLT ▲	Switches the present voltage value for resistance calculation to the next upper one. You can change settings on the measurement screen. The value changes every time the key is pressed in the following order: 0.1, 0.5, 1, 2.5, 5, 10, 25, 50, 100, 250, 500, 1000, 1500, 2000, 2500, 3000, 3500, 4000, 4500, and 5000	p. 35
5	VOLT ▼	Switches the present voltage value for resistance calculation to the next lower one. You can change settings on the measurement screen. The value changes every time the key is pressed in the reverse order of the above.	
6	COMP	Displays the comparator settings screen.	p. 69
7	LOAD/SAVE	Displays the panel load / panel save screen.	p. 73
8	SPEED	Switches the measurement speed. You can change settings on the measurement screen. The speed changes every time the key is pressed in the following order: FAST, FAST2, MED, SLOW, SLOW2, and returns back to FAST. Some measurement speeds are not available depending on the current range setting.	p. 36
9	LOCAL	Disables the remote control (communicating with an external device) and enables the key operation.	p. 118
10	START	Starts measurement.	–

No.	Key	Description	Reference
11		Stops measurement.	–
12		<ul style="list-style-type: none"> • Moves the cursor to another setting item or digit. • Changes numerical values. 	p. 25
13		<ul style="list-style-type: none"> • Cancels the setting. • Returns to the measurement screen from other screens. 	–
14		Confirms the setting.	–
		Inputs the trigger if the external trigger setting is used.	p. 46
15		Moves the screen to another menu settings screen.	p. 21
16		Function keys. Selects item on each settings screen.	–

1.3 Screen Configuration and Operation

The screens of the instrument consists of the measurement screens and the settings screens. For information about the settings screen, see “Displaying the various menu settings screens” (p. 23).

Measurement screens

Press the **F3** key [MONI] to switch between the 1-channel display and the 4-channel display.

1-channel display

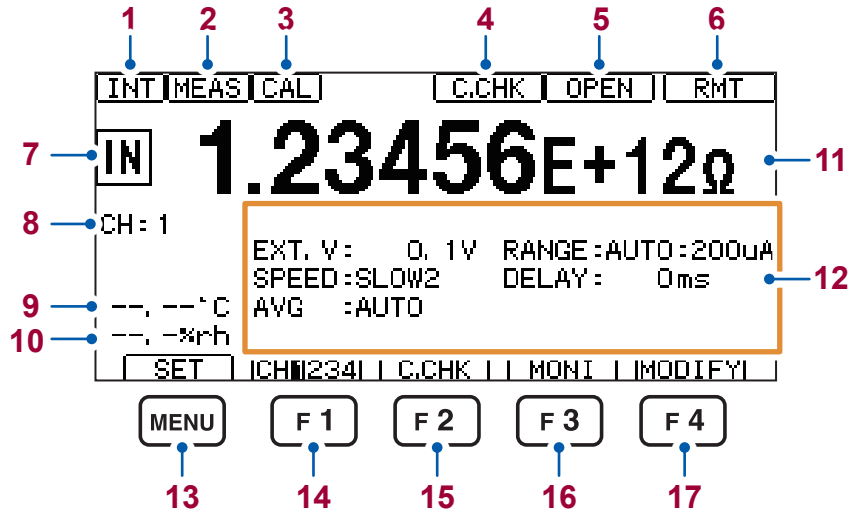

4-channel display

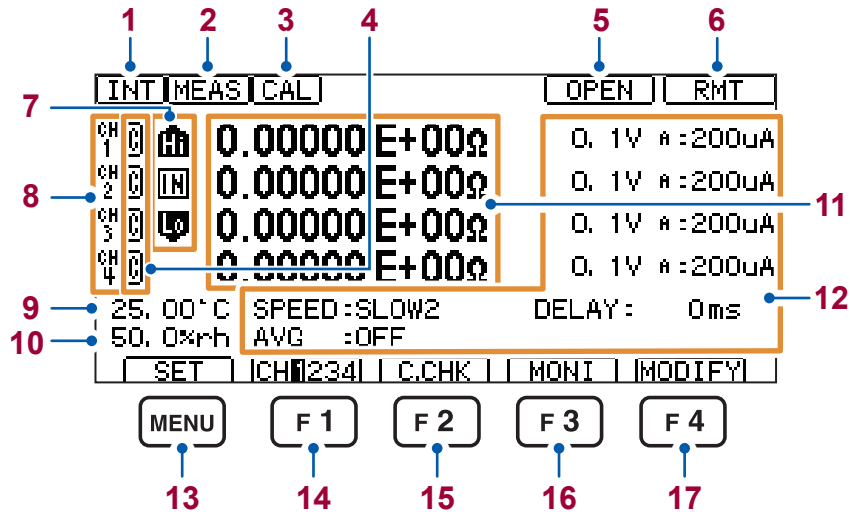

Displayed items

No.	Content	Description		Reference
1	Trigger setting	Displays the presently set trigger.		p. 46
		[INT]	Internal trigger	
		[EXT]	External trigger	
2	Sampling data	Appears during the sampling data.		–
3	Self-calibration	Appears during the self-calibration.		p. 47
4	Contact check	Appears when the contact check function is enabled. Highlighted in reverse video if a contact error occurs.		p. 53
5	Open correction execution result	Displays the result when the open correction is executed once.		p. 52
6	Key lock	[K.LOCK]	Appears while the key lock function is activated.	p. 80
	Remote	[RMT]	Appears while the instrument is placed in the remote status (communicating with an external device). Pressing the LOCAL key disables the remote control.	p. 118
7	Measurement judgments	Displays the judgment results if the measurement judgment function is enabled.		p. 69
8	Channel numbers	Displays the presently selected channel number when using the 1-channel display.		–
9	Temperature	Displays temperature and humidity if the Humidity Sensor is connected.		p. 29 p. 137
10	Humidity	Displays an error message if the Humidity Sensor is not connected to the instrument.		
11	Measured values	Displays the measured values corresponding to the measured value display mode.		p. 33
12	Measurement conditions	[EXT.V]	Voltage value for resistance calculation	p. 35
		[SPEED]	Measurement speed	p. 36
		[RANGE]	Current range	p. 37
		[DELAY]	Delay function	p. 43
		[AVG]	Average function	p. 44
13	MENU key [SET]	Pressing the MENU key displays the menu settings display.		p. 24
14	F1 key [CH1234]	The presently selected channel number is highlighted in reverse video. The channel is switched in the order from CH1 through CH4 every time the F1 key is pressed.		–
15	F2 key [C.CHK]	Pressing the F2 key executes the contact check (only with the contact check set to [ON]).		p. 53
16	F3 key [MONI]	Pressing F3 key switches between the 1-channel display and the 4-channel display.		–
17	F4 key [MODIFY]	Pressing the F4 key enables the measurement conditions to be changed.		–

Settings screens

For information about the settings display, see “Displaying the various menu settings screens” (p. 23).

1.4 Basic Key Operation

Displaying measurement screen

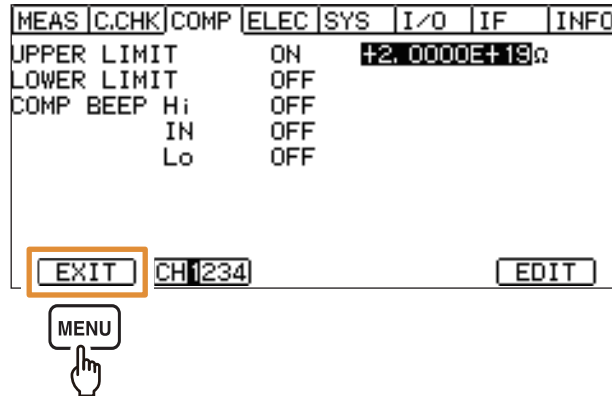

You can also press the **ESC** key to return to the measurement screen.

Displaying the various menu settings screens

This section shows an example of switching the measurement screen to the **[SYS]** screen.

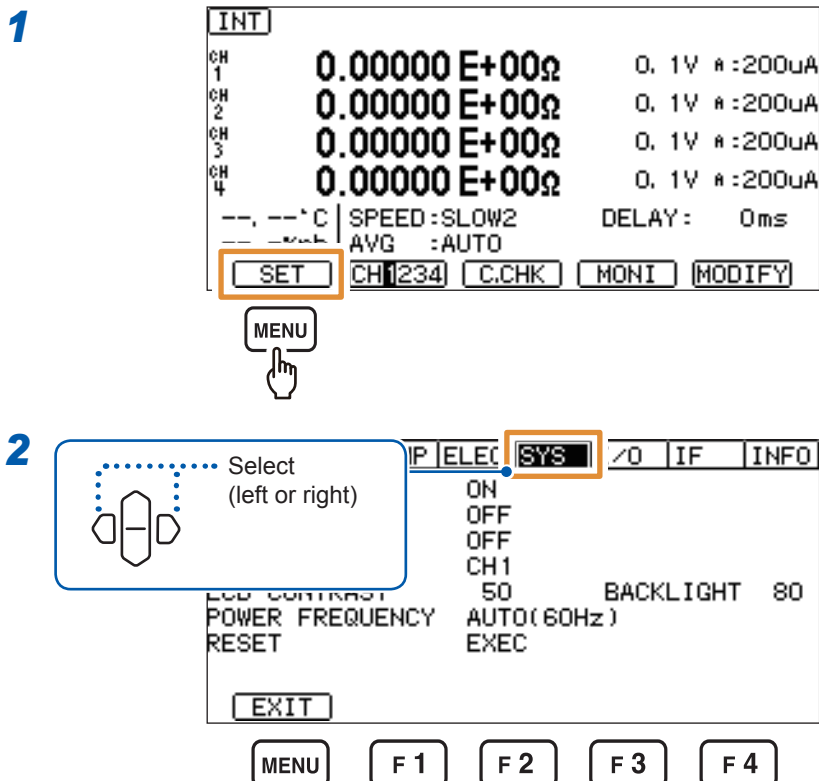

In this manual, the procedure to display the settings screen is described as follows:

Procedure to display the settings screen: (Measurement screen) **MENU** key > **[SYS]** tab

(That is to say, to display the settings screen, on the measurement screen, press the **MENU** key, and then press the keys **[Left]** and **[Right]** to select the **[SYS]** tab.)

List of menu settings screens

[MEAS] screen

Configuring settings for measurement

MEAS	C.CHK	COMP	ELEC	SYS	I/O	IF	INFO
MEAS FORMAT	EXP					DIGIT 6	
DISP UPDATE	ON						
TRIGGER	INTERNAL						
SELF CALIBRATION	ON				600s		
[EXIT]							

[C.CHK] screen

Configuring settings for open correction and contact check

MEAS	C.CHK	COMP	ELEC	SYS	I/O	IF	INFO
C. CHECK SIGNAL	EACH						
FREQ	300kHz						
WORK. C	NORMAL (>10pF)						
CABLE	1.0m						
DELAY	0ms						
OPEN VALUE	--, ---pF						
CONTACT CHECK	OFF					LIMIT 0.00pF	
[EXIT]							

[COMP] screen

Configuring settings for measured value judgment

MEAS	C.CHK	COMP	ELEC	SYS	I/O	IF	INFO
UPPER LIMIT	OFF						
LOWER LIMIT	OFF						
COMP BEEP	Hi	OFF					
	IN	OFF					
	Lo	OFF					
[EXIT]							

[ELEC] screen

Configuring settings for calculating resistivity

MEAS	C.CHK	COMP	ELEC	SYS	I/O	IF	INFO
D1(IN DIAMETER)	50.0mm						
D2(OUT DIAMETER)	70.0mm						
T(THICKNESS)	0.1mm						
K(ACTUAL)	500.00						
[EXIT]							

[SYS] screen

Configuring system settings

MEAS	C.CHK	COMP	ELEC	SYS	I/O	IF	INFO
KEY CLICK	ON						
KEY LOCK	OFF						
MEMORY	OFF						
D/A OUTPUT	CH1						
LCD CONTRAST	50				BACKLIGHT 80		
POWER FREQUENCY	AUTO(60Hz)						
RESET	EXEC						
[EXIT]							

[I/O] screen

Configuring settings for external control

MEAS	C.CHK	COMP	ELEC	SYS	I/O	IF	INFO
TRIG EDGE	ON EDGE						
TRIG FILTER	OFF						
C. CHK GO	NORMAL						
EOM MODE	HOLD						
EXT I/O TEST	EXEC						
[EXIT]							

[IF] screen

Configuring settings for interface.

MEAS	C.CHK	COMP	ELEC	SYS	I/O	IF	INFO
INTERFACE	RS-232C						
SPEED	9600						
DATA OUT	OFF						
CMD MONITOR	OFF						
[EXIT]							

[INFO] screen

Displays the information of this instrument.

MEAS	C.CHK	COMP	ELEC	SYS	I/O	IF	INFO
MODEL	SM7420						
MAIN CPU	V1.00						
SUB CPU	CH1/CH2 V1.00 / V1.00						
	CH3/CH4 V1.00 / V1.00						
CPLD	V1.00						
SERIAL NO.	123456789						
[EXIT]							

Selecting settings items

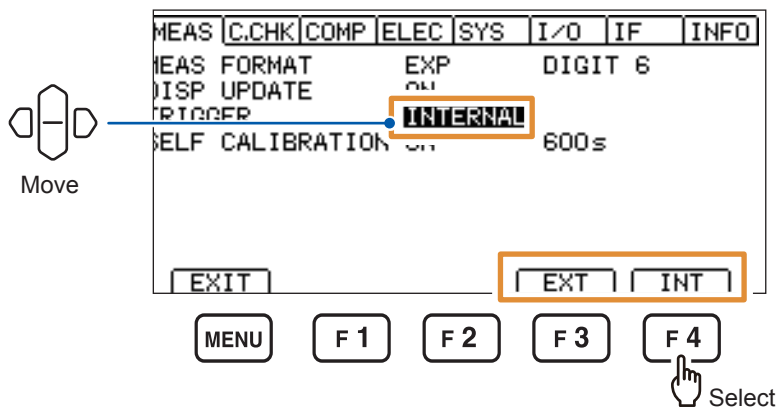

Methods for changing numerical values

The two options available are: using the cursor keys and using the numeric keypad.

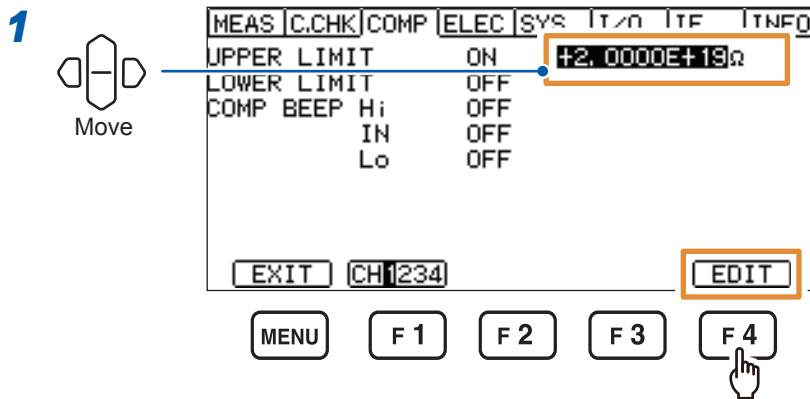

2 (If using the cursor keys)

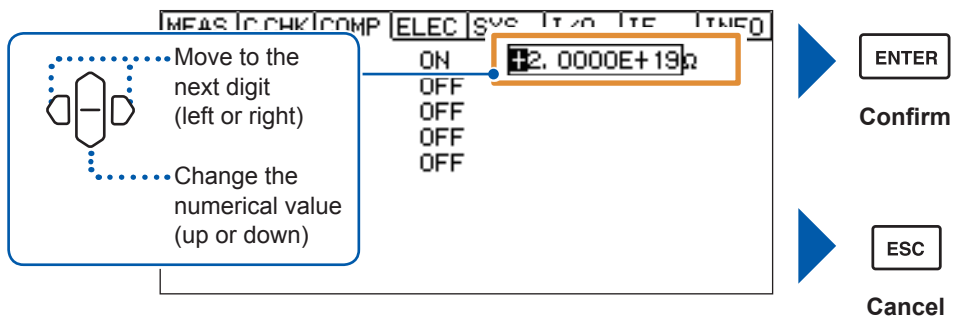

(If using the numeric keypad)

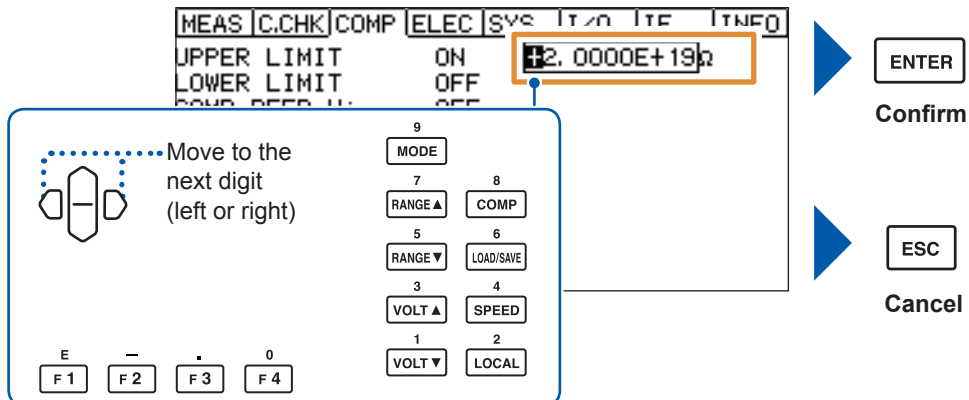

If you press the **ESC** key while changing the numerical value, the numerical value change will be canceled.
If you press the **ENTER** key, the changed content is confirmed.

2 Preparing for Measurement

2.1 Connecting Power Cord to Instrument

Be sure to read “Before connecting the power cord to the instrument” (p. 10) beforehand.

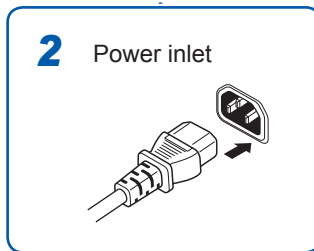
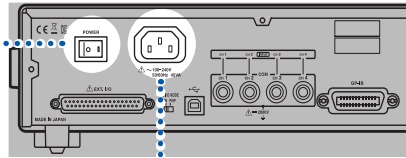
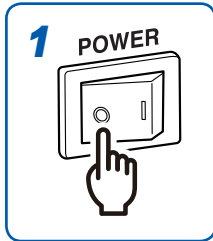

- 1** Check that the power switch is in the off position (○).
- 2** Check that the power voltage is in the range indicated on the rear, and then connect the power cord to the power inlet.
- 3** Connect the plug of the power cord into an outlet.

2

Preparing for Measurement

2.2 Connecting Measurement Leads to Instrument

Be sure to read “Before connecting the measurement leads and electrode to the instrument” (p. 10) beforehand.

The measurement leads are optional. (p. 4)

Required leads: Measurement lead (red) and measurement lead (black) ×1 each

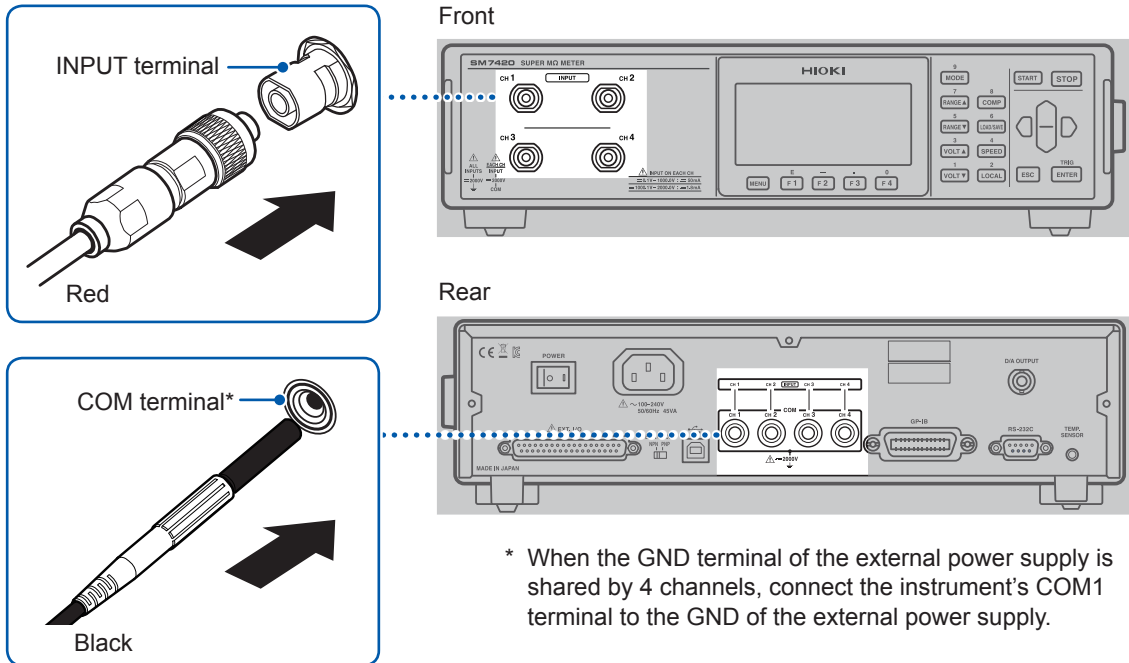

How to connect measurement lead (red) to the instrument

- 1** Attach the connector to the INPUT terminal.
- 2** Tighten the screw by turning it clockwise.

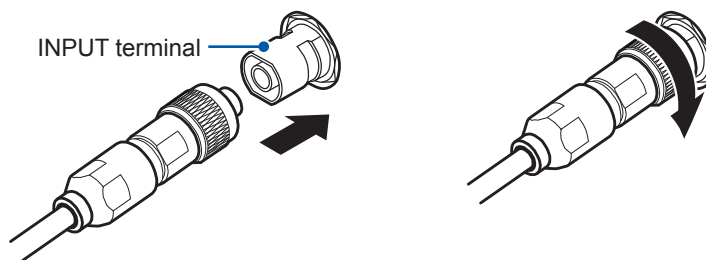

2.3 Connecting Electrode

Be sure to read “Before connecting the measurement leads and electrode to the instrument” (p. 10) beforehand.

Electrodes are optional. (p. 5)

To connect an electrode to the instrument, refer to the Instruction Manual that comes with each of the electrode.

2.5 Outputting Measurement Current Value Converted to Analog Signal

Use the D/A output function to log the output together with the output of other measuring instruments such as recorders.

A voltage of 2.0 V is output if the measured current value reaches the maximum display value of the present current range's scale.

If the measured value is out of the present current range, a voltage of 2.5 V is output.

If the measured current value shows a minus value, a voltage of 0 V is output.

(Example: With the current range setting set to 20 pA, a voltage of 2.0 V is output when the value "19.9999 pA" is displayed)

Relevant output channel must be set.

See "8.4 Setting D/A Output" (p. 83).

How to connect the output cable to the instrument

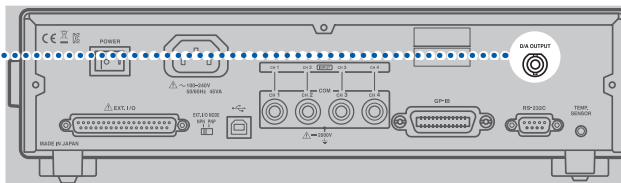
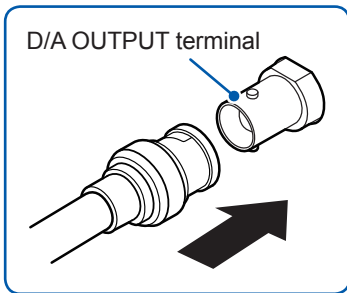

- 1 Check the orientation of the slots in the BNC connector and ensure that it fits into the bayonet lugs of the instrument side.

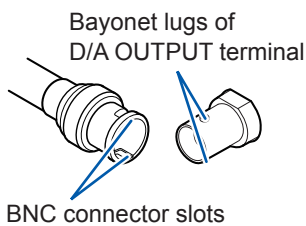

- 2 Align the slots in the BNC connector along the bayonet lugs of the instrument, and attach the BNC connector to the instrument connector.

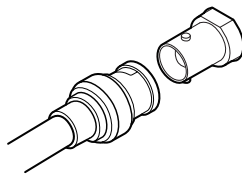

- 3 Turn the BNC connector clockwise to lock it.

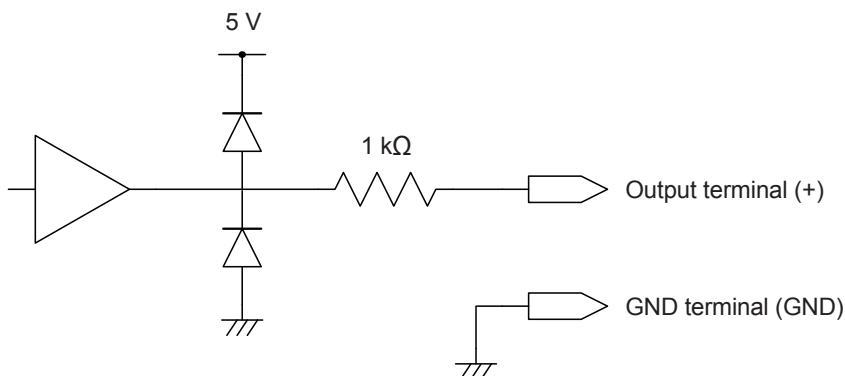
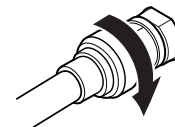

- The GND terminal of D/A output is connected to the ground (case metal part).
- The output impedance is 1 k Ω . Use connected instruments with input impedance of 10 M Ω or more. (The output voltage is divided by the output resistance and the input impedance. For 1 M Ω , it is lower by 0.1%.)
- External noises may be superimposed on analog signals if cables are connected to the instrument. If necessary, use a band-limiting filter, etc. in the connected instrument.
- The output voltage is updated with each current measurement sampling cycle.
- The recorded wave form will be in a staircase pattern. (because the output circuit response is very fast with respect to the update period)
- Output voltage is reduced to 1/10 (or increases by 10 times) even at the same resistance value according to the change of range in auto-range. It is recommended to use the manual range.
- Turning off the instrument sets the output to a voltage of 0 V. Moreover, an irregular voltage with an amplitude that is within the maximum output voltage is output at the moment when the power switch on the rear is flipped to the on position.
- Set the measurement speed to **[FAST]** and the self-calibration to **[OFF]** (execute manually) to ensure that the D/A output response time is at its fastest.
See “3.3 Setting Measurement Speed” (p. 36) and “4.4 Maintaining Measurement Accuracy (Self-Calibration Function)” (p. 47).

2.6 Turning On/Off Instrument

Turn the instrument on or off using the power switch on the rear.

For more accurate measurement, warm up the instrument for 30 minutes or more after turning on the instrument.

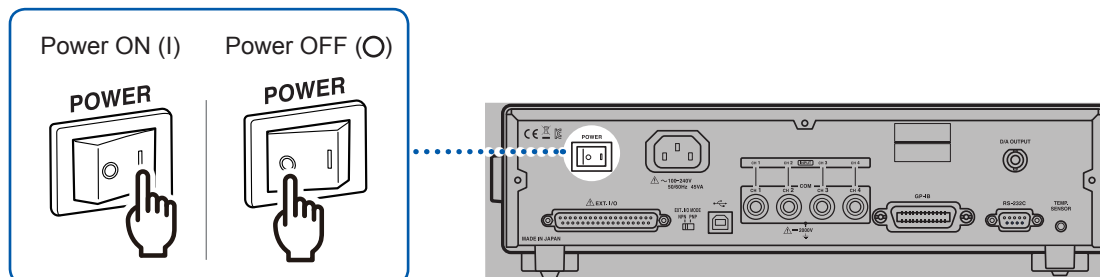

The self-test is executed automatically after startup (ROM/RAM check).

If an error is displayed on the LCD screen, the instrument is necessary to be repaired. Please contact your authorized Hioki distributor or reseller.

See “Error display and solution” (p. 136).

2.7 Inspection Before Use

Before using the instrument, verify that it operates normally to ensure that no damage occurred during storage or shipping. If you find any damage, contact your authorized Hioki distributor or reseller.

Verifying the instrument and the peripheral devices

Inspection items	Solution
Is the power cord insulation torn, or is any metal exposed?	Do not use the instrument if damage is found, as an electric shock or short-circuit accidents could result. Contact your authorized Hioki distributor or reseller.
Is the insulation of the connected lead or the connection cords torn, or is any metal exposed?	If any damage is found, it may cause an electrical shock. If this happens, replace the measurement probe or connection cords with ones specified by Hioki.
Is the instrument damaged?	

Verifying the instrument on start-up

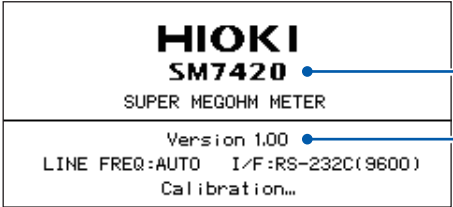
Inspection items	Solution
Are "Model name" and "Version number" displayed on the screen when the instrument is turned on?	<p>If "Model name" and "Version number" are not displayed, the instrument may be malfunctioning. Request repairs.</p> 
Is the measurement screen displayed after the self-test?	If the screen does not display anything, the instrument may be malfunctioning internally. Request repairs.

3 Basic Measurement

3.1 Setting Measured Value Display Mode

Press the **MODE** key to switch the measured value display modes.

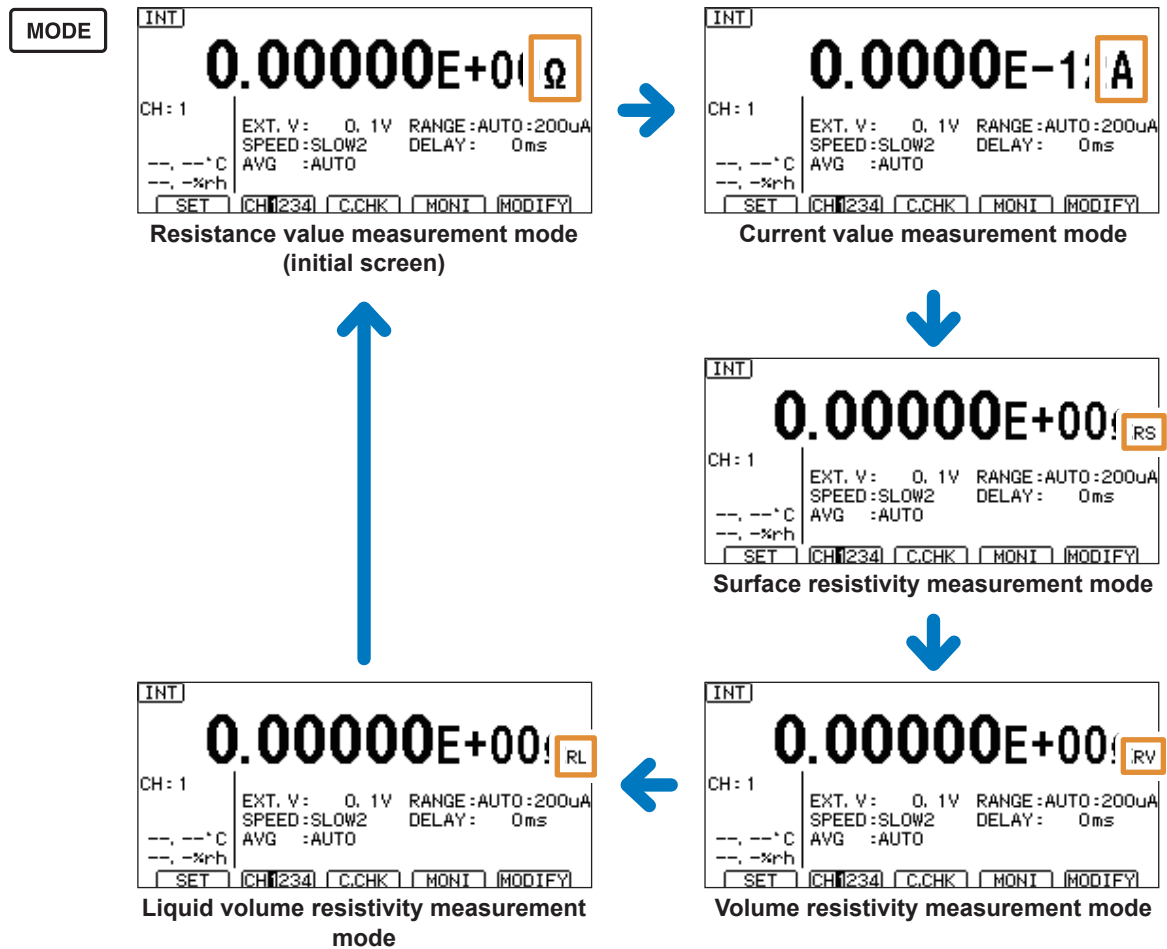

Measurement conditions must be set to measure surface resistivity and volume resistivity. See "4.8 Setting Resistivity Calculation (Resistivity Measurement Function)" (p. 55).

Changing display notation

Procedure to display the settings screen: (Measurement screen) **MENU** key >  **[MEAS]** tab

Press the **F3** or **F4** key to change the value.

- [EXP]** Exponential notation: Displays values, expressed in exponential notation, to five decimal places. (Example: 1.00000E+16 Ω) (default setting)
- [UNIT]** Decimal notation: Displays values, expressed in decimal notation, that have six significant figures. (Example: 10.0000 PΩ)

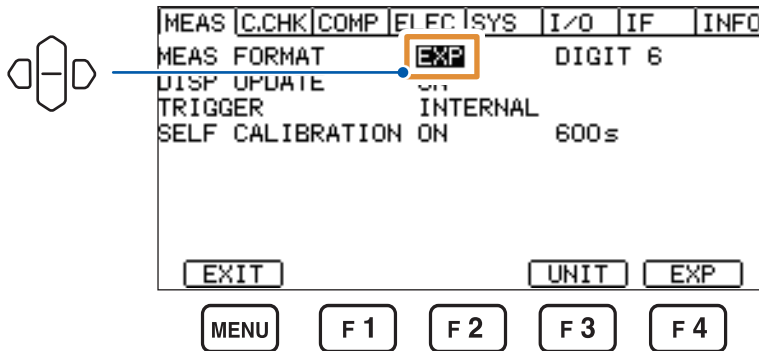

Changing displayed digits

Procedure to display the settings screen: (Measurement screen) **MENU** key >  **[MEAS]** tab

Press any key from **F1** to **F4** to change the displayed digits.

3 digits to 6 digits (Default setting: 6 digits)

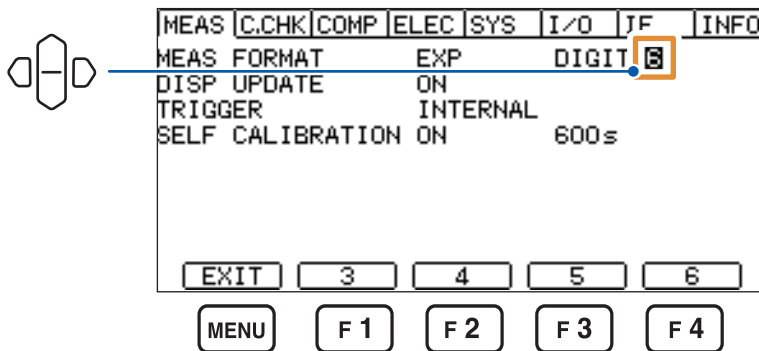

3.2 Setting Voltage Value for Resistance Calculation

Set the voltage value for resistance calculation.

The numerical value can also be changed with the numeric keypad. See “Methods for changing numerical values” (p. 25).

Press the **VOLT▲** key or the **VOLT▼** key on the measurement screen.

Pressing the **F4** key [**MODIFY**] enables also the function keys to select the voltage value for resistance calculation.

0.1, 0.5, 1, 2.5, 5, 10, 25, 50, 100, 250, 500, 1000, 1500, 2000, 2500, 3000, 3500, 4000, 4500, 5000
(Default setting: 0.1)

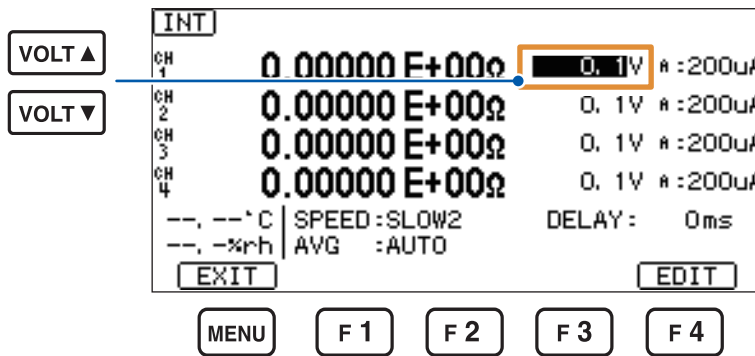

Pressing the **F4** key [**EDIT**] enables the numerical value to be changed in increments of 0.1 V.

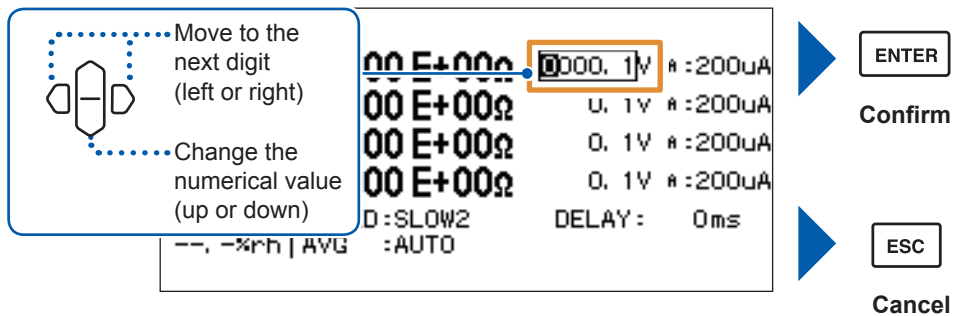

3.3 Setting Measurement Speed

Settings for measurement speed are shared by all channels.
 The slower the measurements, the more the accuracy improves.
 See “Current measurement accuracy” (p. 121).

Some measurement speeds are not available depending on the current range setting. If the measurement speed cannot be changed, check the current ranges of the other channels.
 See “Available setting depending on current ranges and measurement speed” (p. 36).

Press the SPEED key on the measurement screen.

Pressing the F4 key [MODIFY] enables also the function keys to select the measurement speed.

FAST, FAST2, MED, SLOW, SLOW2 (Default setting: SLOW2)

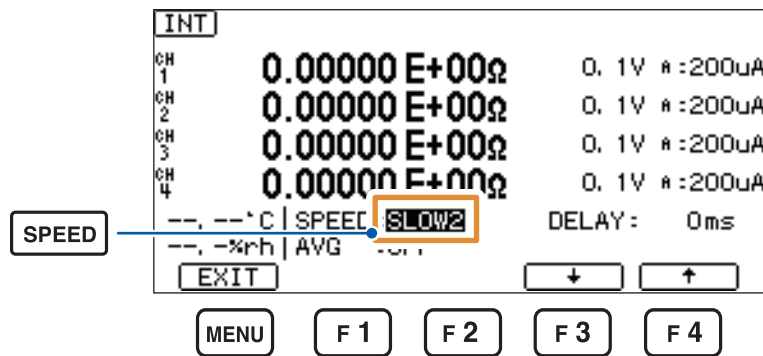

The measurement speed changes every time the F3 key [↓] is pressed in the following order: FAST, FAST2, MED, SLOW, and SLOW2.

The measurement speed changes every time the F4 key [↑] is pressed in the following order: SLOW2, SLOW, MED, FAST2, and FAST.

Available setting depending on current ranges and measurement speed

✓: Setting available, -: Setting not available

Measurement speed Range	FAST	FAST2	MED	SLOW	SLOW2
20 pA	-	-	-	✓	✓
200 pA	-	-	✓	✓	✓
2 nA	✓	✓	✓	✓	✓
20 nA	✓	✓	✓	✓	✓
200 nA	✓	✓	✓	✓	✓
2 μA	✓	✓	✓	✓	✓
20 μA	✓	✓	✓	✓	✓
200 μA	✓	✓	✓	✓	✓
2 mA	✓	✓	-	-	-

3.4 Changing Current Range

Change the current range if the measured current value or the measured resistance value exceeds the measurable range or if measurement with another measure accuracy is preferred. See “Current measurement accuracy” (p. 121).

No setting for resistance range is required. (If the current range is set to **[AUTO]**, the resistance range will be automatically selected).

Some ranges are not available depending on the measurement speed setting. If the current range cannot be changed, check the measurement speed.

See “Available setting depending on current ranges and measurement speed” (p. 36).

Current range can be set for each channel.

The channel switches to another in the order from CH1 through CH4 every time the **F1** key **[CH1234]** is pressed.

Press the **RANGE▲** key or the **RANGE▼** key on the measurement screen.

Pressing the **F4** key **[MODIFY]** enables also the function keys to be used to select the current range.

20 pA, 200 pA, 2 nA, 20 nA, 200 nA, 2 uA, 20 uA, 200 uA, 2 mA, AUTO
(Default setting: AUTO)

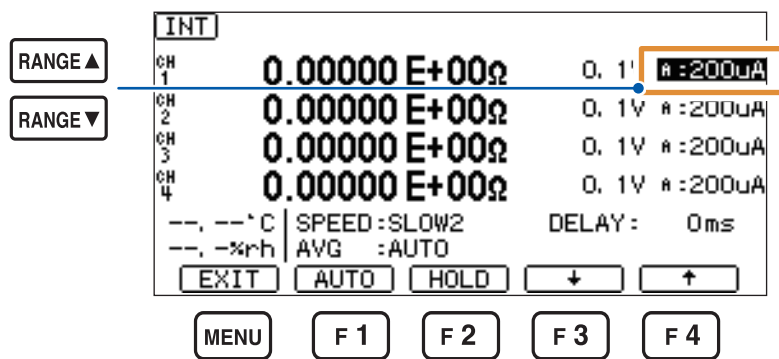

Pressing the **F1** key **[AUTO]** sets the range to AUTO immediately.

Pressing the **F2** key **[HOLD]** fixes the current range on the presently selected range.

Pressing the **F3** key **[↓]** switches the current range to the next lower range.

Pressing the **F4** key **[↑]** switches the current range to the next upper range.

3.5 Connecting Measurement Leads or Electrode to Object to Be Measured

Connect the measurement leads or electrode (both are optional) to the object to be measured. Measurement fixtures can be available depending on the object to be measured.

<p>Using measurement fixtures is recommended</p>	<ul style="list-style-type: none"> • Objects to be measured (components, circuits, etc.) are the same in form. • Objects to be measured are extremely small in size. • Large amount of objects are to be measured. • Objects are to be measured using numerous points.
<p>Using a measurement fixture is not recommended (Use measurement leads.)</p>	<ul style="list-style-type: none"> • Objects to be measured are different in form from each other. • Objects to be measured are large in size. • Objects to be measured are heavy. • Small number of objects are to be measured.

For measurement examples using electrodes and a measurement fixture, see “5 Measurement Methods Suitable for Various Objects to Be Measured” (p. 59).

To connect an electrode to objects to be measured, refer to the Instruction Manual that comes with each of the electrodes.

If measuring resistance values and electric currents

Pin type test lead

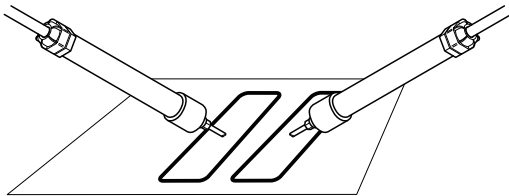

Clip type test lead

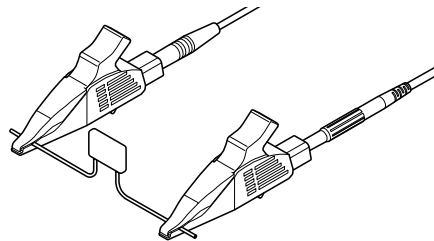

3.6 Starting/Stopping Measurement

Be sure to read “Before performing a measurement” (p. 11) beforehand.

Internal trigger (INT) (default setting)	Pressing the START key starts the measurement. Pressing the STOP key stops the measurement.
External trigger (EXT)	Pressing the START key sets the instrument waiting for a trigger. Inputting a trigger signal starts a measurement. Pressing the STOP key stops the instrument waiting for a trigger.

3.7 Confirming Measurement Results

Detecting a measurement abnormality

If the measurement is not correctly performed, an error message appears on the screen.
See “Measurement errors” (p. 137).

Temperature measurement indication

If the Humidity Sensor is not connected to the instrument (Display: [---.---°C], [---.-%rh])

The Humidity Sensor is not connected to the instrument. Thus, temperature cannot be measured.
If the temperature measurement is not necessary, connecting the Humidity Sensor to the instrument is not required.

Out-of-range indication

The out-of-range indication for each of the parameters is displayed due to causes listed below.

Parameters	Out-of-range indication	Cause
Resistance value	[Current Over Range]	The measured value exceeds the indication range of the present current range. *This means that the resistance is low.
Current		
Surface resistivity Rs		
Volume resistivity Rv		
Temperature	[+Over°C]	The measured value is greater than 80.0°C.
	[-Over°C]	The measured value is lower than -40.0°C.
Humidity	[Over%rh]	The measured value is greater than 90% RH.

3.8 Basic Measurement Examples

Measurement of the resistance value of a capacitor is explained with an example.

Examples of setting contents

Measured value display mode	Resistance value measurement mode (initial screen)
Voltage value for resistance calculation	[0.1 V]
Current range	[AUTO]
Measurement speed	[SLOW2]

Set the trigger source to the internal trigger (INT).

The channel switches to another in the order from CH1 through CH4 every time the **F1** key [CH1234] is pressed.

- 1 Press the **MODE** key to display the Resistance measurement screen. (p. 33)

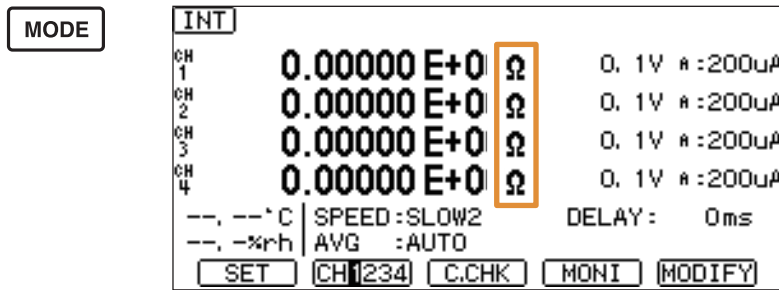

The instrument displays values that include the input resistance of 1 kΩ (±10%).

- 2 Press the **VOLT▲** key or **VOLT▼** key to set the voltage value for resistance calculation to [0.1 V]. (p. 35)

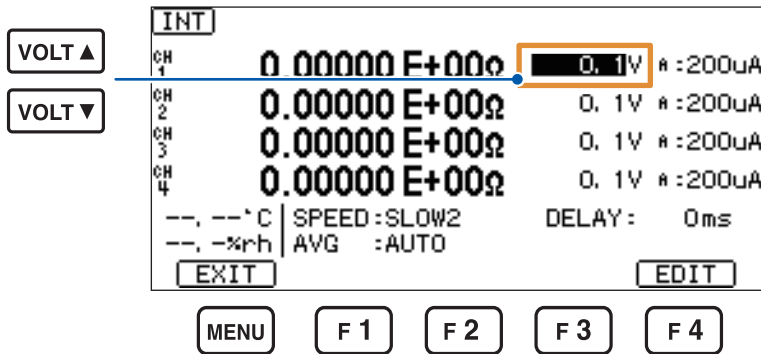

- 3 Press the **SPEED** key to set the measurement speed to [SLOW2]. (p. 36)

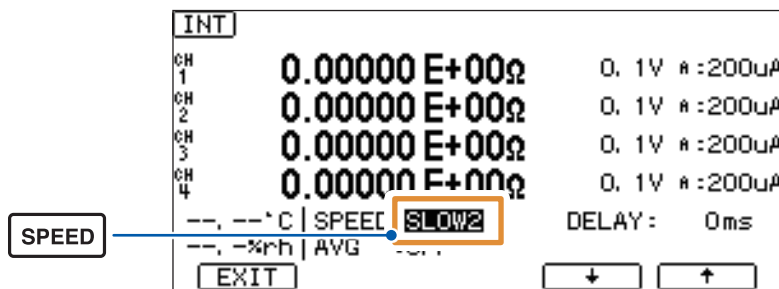

- Press the F1 key [AUTO]; otherwise, press the RANGE▲ key and the RANGE▼ key to set the range to [AUTO]. (p. 37)

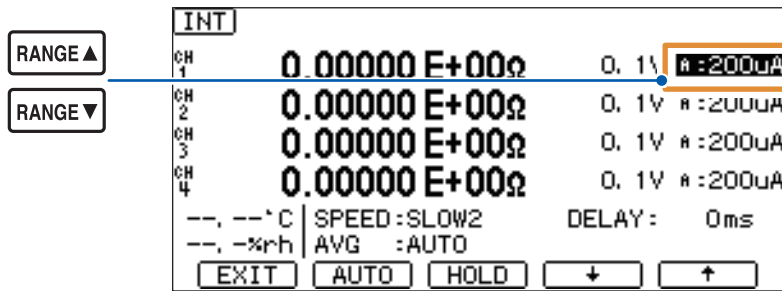

- Connect the clip type test lead to both terminals of the capacitor.

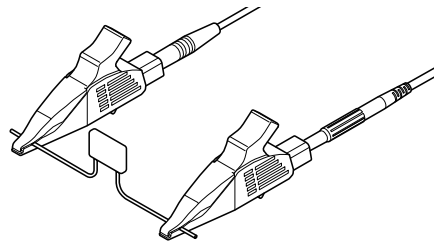

- Apply a voltage using an external power supply.

- Press the START key to start the measurement.



The resistance value is measured.

- Press the STOP key to stop the measurement.



4.1 Starting Measurement After Measured Value Becomes Stable (Delay Function)

For the external trigger (EXT), set the time from when the trigger is input to when the measurement starts. (The delay time elapses after the trigger is input each time.) With the trigger source setting set to the internal trigger (INT), no delay time elapses after the trigger. Set it on the Measurement screen.

- 1 Press the **F4** key [**MODIFY**] to enable the measurement conditions to be changed.

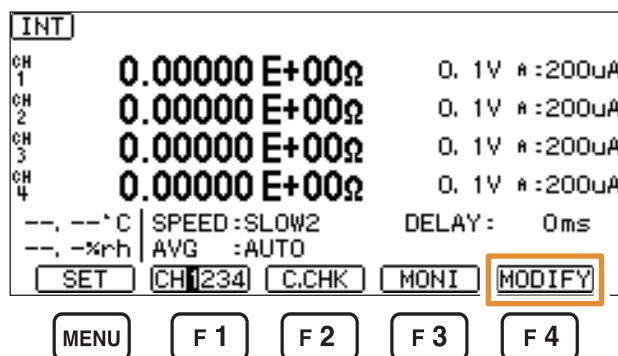

Pressing the **ESC** key cancels the changes of the measurement conditions.

- 2 Set the delay time.

0 ms to 9999 ms (default setting: 0 ms)

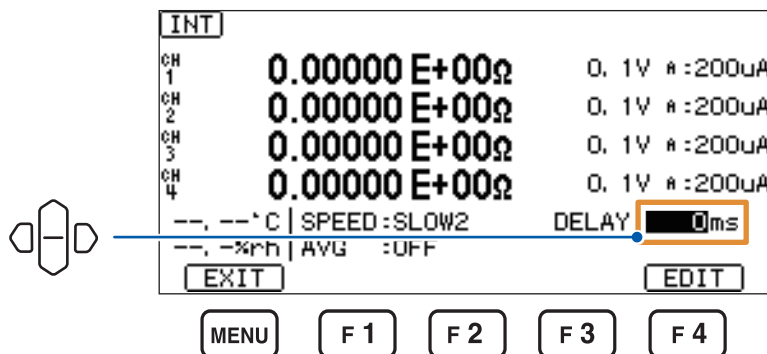

Pressing the **F4** key [**EDIT**] enables the numerical value to be changed in increments of 1 ms.

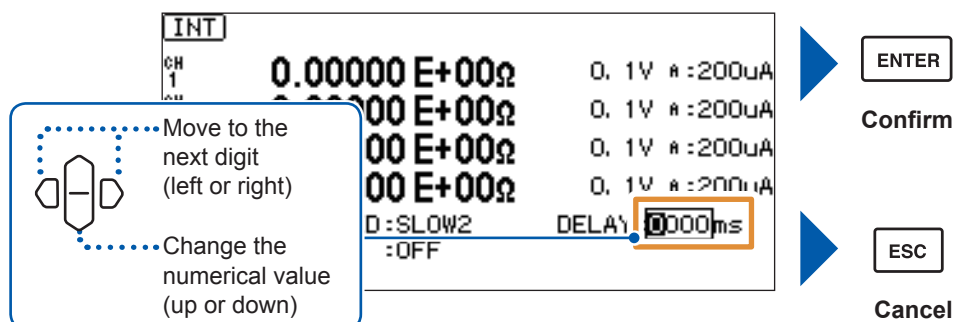

The numerical value can also be changed with the numeric keypad. See "Methods for changing numerical values" (p. 25).

4.2 Reducing Variation in Measured Values (Average Function)

The average for the set number of measured values will be displayed as the result. This function can reduce the variation in the measured values. Set it on the Measurement screen.

- 1 Press the **F4** key [**MODIFY**] to enable the measurement conditions to be changed.

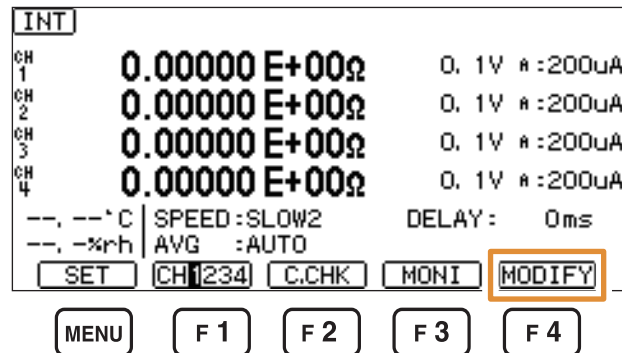

Pressing the **ESC** key cancels the changes of the measurement conditions.

- 2 Select whether to perform the average process or not.

- [AUTO]** The average frequency changes automatically depending on the variation in the measured values.
- [HOLD]** Moving average (However, arithmetic averages are calculated with the trigger source setting set to the external trigger.)
- [OFF]** Does not perform the average process (default setting).

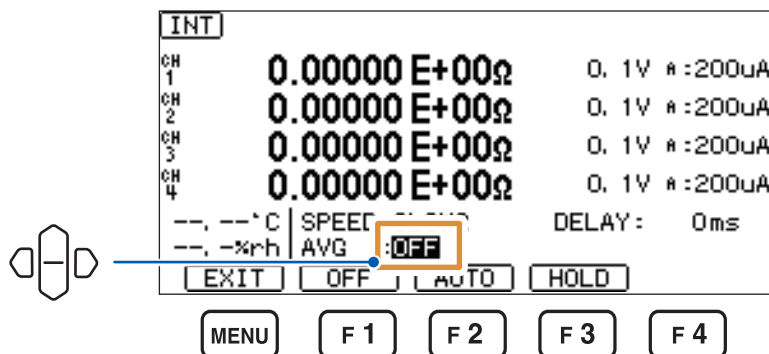

3 If [HOLD] is selected, set the average frequency.

2 to 255 times (default setting: 2 times)

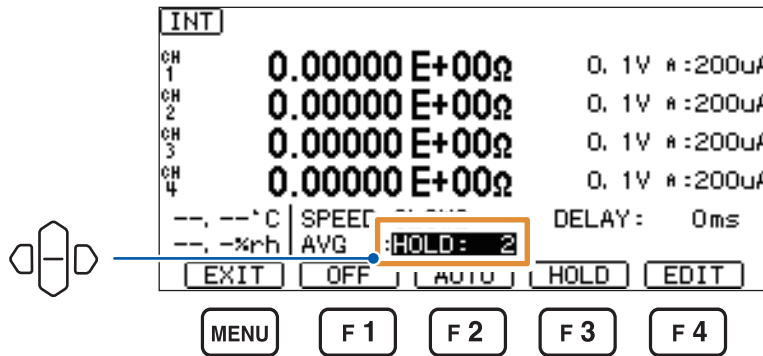

Pressing the **F4** key [**EDIT**] enables the numerical value to be changed.

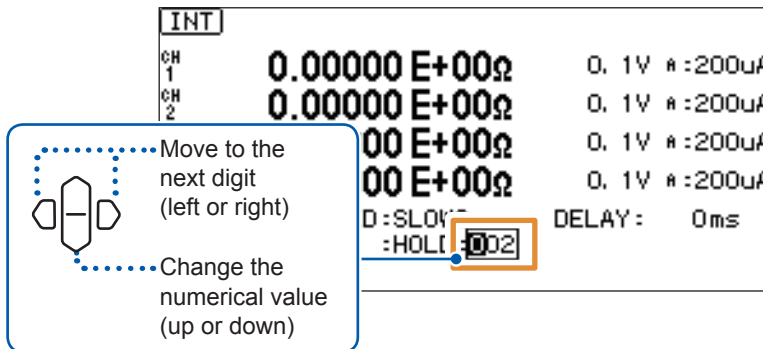

Move to the next digit (left or right)

Change the numerical value (up or down)

The numerical value can also be changed with the numeric keypad. See “Methods for changing numerical values” (p. 25).

4

4.3 Changing Measurement Starting Conditions (Trigger Function)

The following two methods are available to set the measurement starting conditions.

External trigger	After the START key is pressed, when the external trigger signal is input, the measurement starts.
Internal trigger	After the START key is pressed, the internal triggers are generated automatically and measurements are repeatedly performed.

Setting the trigger mode

Procedure to display the settings screen: (Measurement screen) **MENU** key >  **[MEAS]** tab

- [EXTERNAL]** External trigger
- [INTERNAL]** Internal trigger (default setting)

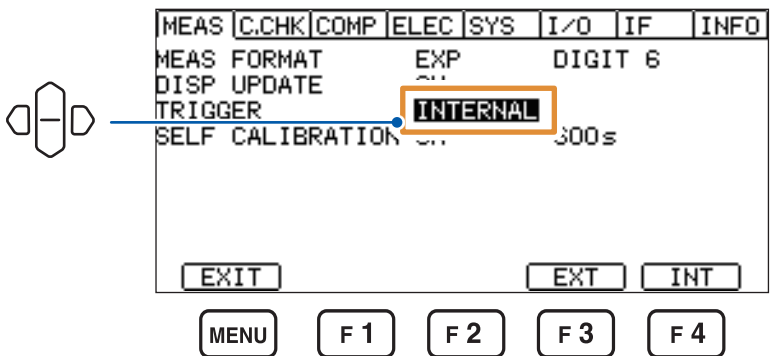

Inputting an external trigger

- For inputting triggers using the keys
After the **START** key is pressed on the Measurement screen, when the **ENTER (TRIG)** key is pressed, the measurement is performed once.
- For inputting triggers to the EXT I/O
When the TRIG terminal of the EXT I/O terminal on the rear is short-circuited with the ISO_COM terminal, the measurement is performed once. (p. 90)
- For inputting triggers to the communications interface
When the command ***TRG** is sent to the communication interface, the measurement is performed once.

IMPORTANT

- If it is set to the internal trigger, the trigger input to the EXT I/O and the command ***TRG** are ignored.
- Measurement can be interrupted in the middle by pressing the **STOP** key.

4.4 Maintaining Measurement Accuracy (Self-Calibration Function)

The self-calibration corrects the offset voltage and the gain drift in the internal circuit. The default setting is **[ON]**: thus, the self-calibration is executed automatically every time the set interval elapses (default setting: 600 s). Regardless of whether the self-calibration is set to on or off, the self-calibration is automatically executed once at a startup and five minutes later.

IMPORTANT

- Executing self-calibration is a condition for maintaining the measurement accuracy of the instrument. If this function is set to **[OFF]**, manually calibrate the instrument regularly. Be sure to perform self-calibration manually especially after warm-up of the instrument or when the ambient temperature has changed by 2°C or more.
- A trigger generated during self-calibration causes the instrument to suspend an immediate measurement. Once the self-calibration is complete, the instrument starts the measurement, with the result that it takes longer between the trigger input and the end of the measurement.

How to execute the self-calibration manually

Pressing the **F2** key **[EXEC]** while the settings screen is displayed executes the self-calibration once.

Procedure to display the settings screen: (Measurement screen) **MENU** key >  **[MEAS]** tab

1 Select whether to perform the self-calibration automatically or not.

- [ON]** Yes (default setting)
[OFF] No (It is necessary to execute self-calibration manually at periodic intervals.)

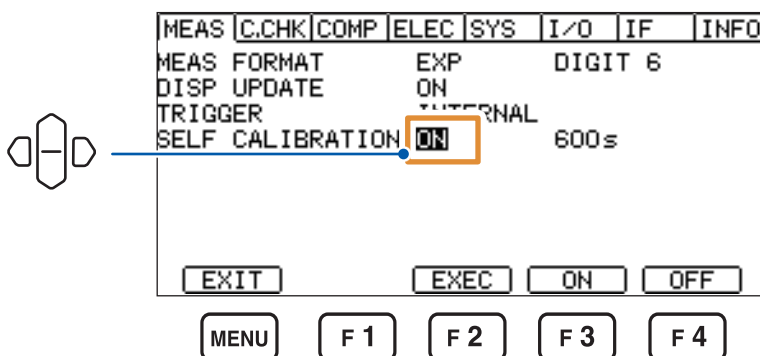

2 If **[ON]** is selected, set the self-calibration interval.

1 s to 600 s (default setting: 600 s)

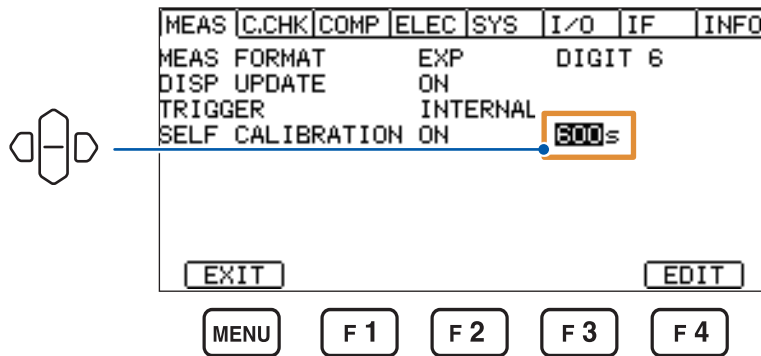

Pressing the **F4** key **[EDIT]** enables the numerical value to be changed.

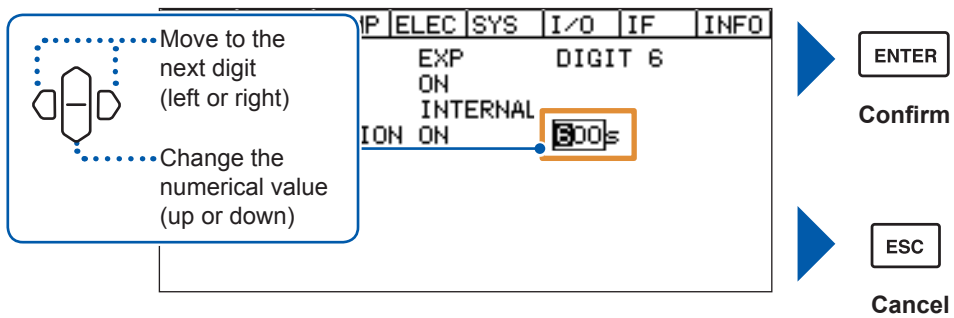

The numerical value can also be changed with the numeric keypad. See “Methods for changing numerical values” (p. 25).

4.5 Contact Check (Various Settings)

While measuring the insulator, if a measurement fixture of the measurement system is not in contact with the measured object, even defective insulation may be wrongly determined to be pass. To avoid such erroneous judgment, the contact check function is used to check if the measurement fixture is brought into contact with the object to be measured. Moreover, because inaccurate contact checks are performed if the capacitance changes with the change in cable length, a correction depending on the cable length is required. Because the instrument can automatically correct the cable length, the auto-correction of the cable length allows the instrument to be used immediately after the cable length is changed.

To perform the contact check accurately, configure the following settings.

Procedure to display the settings screen: (Measurement screen) **MENU** key >  **[C.CHK]** tab

[FREQ]	Contact check frequency
[WORK. C]	Capacitance of object to be measured
[CABLE]	Length of measurement cable
[DELAY]	Delay time

The channel switches to another in the order from CH1 through CH4 every time the **F1** key **[CH1234]** is pressed.

Setting of [FREQ]

Set the frequency of the signal applied during the open correction or the contact check.

245 kHz, 300 kHz (default setting: 300 kHz)

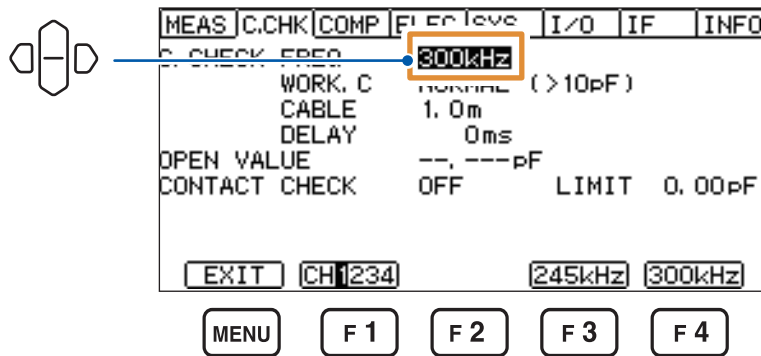

Setting of [WORK.C]

Set the capacitance of the objects to be measured.

[LOW] If the capacitance of the objects to be measured is 10 pF or less

[NORMAL] If the capacitance of the objects to be measured exceeds 10 pF (default setting)

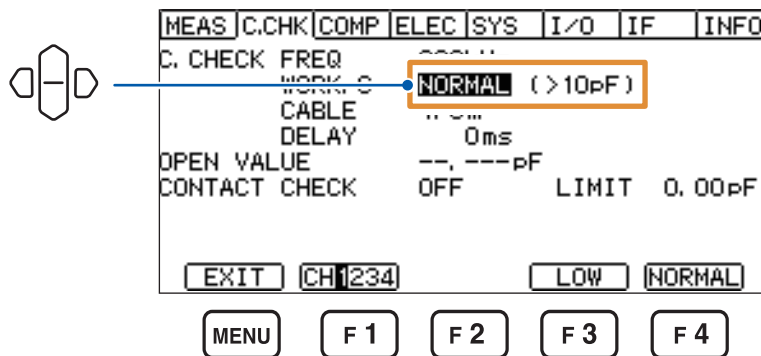

If the capacitance of the object to be measured is unknown, select **[NORMAL]** and then execute the open correction with the object connected to the instrument to obtain its capacitance. Select whether **[LOW]** or **[NORMAL]** depending on this measured capacitance. See “4.6 Canceling Capacitance of Measurement Fixture (Fixture Capacitance Open Correction Function)” (p. 52).

Setting of [CABLE]

Set the cable length.

[AUTO] The cable length is automatically detected and set.

[EDIT] Optional numerical values can be set.
0.5 m to 3.0 m (Can be set in increments of 0.1 m, default setting: 1.0 m)

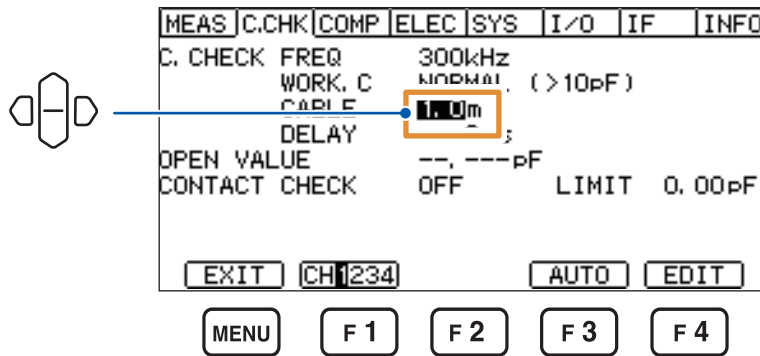

Pressing the **F4** key **[EDIT]** enables the numerical value to be changed.

If using an accessory or an optional cable, press the **F4** key **[EDIT]** to specify its length. If the cable is modified or extended, it is recommended to press the **F3** key **[AUTO]**. Pressing the **F3** key **[AUTO]** executes the cable length correction once. If you change the cables, press the **F3** key **[AUTO]** to execute the cable length correction again.

Setting of [DELAY]

Set the wait time from the TRIG input to the start of the contact check

0 ms to 9999 ms (default setting: 0 ms)

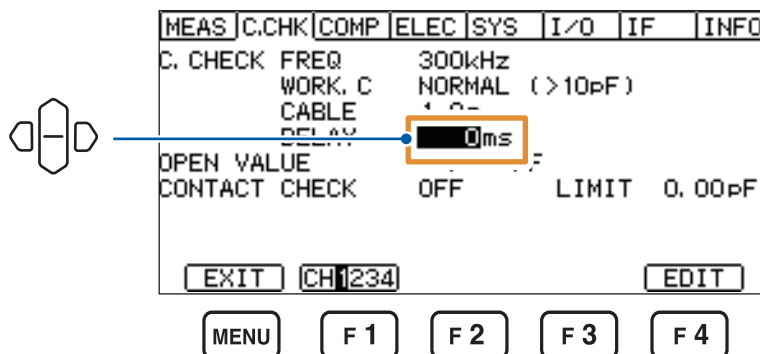

Pressing the **F4** key **[EDIT]** enables the numerical value to be changed.

4.6 Canceling Capacitance of Measurement Fixture (Fixture Capacitance Open Correction Function)

Be sure to read “Before performing the open correction” (p. 12) beforehand.

This function measures the capacitance of a measurement fixture with its terminals open. The fixture capacitance open correction function can reduce the impact of residual impedance of the measurement fixture (such as lead or fixture) and improve the measurement accuracy.

- If the contact check function is set to **[ON]**, always execute “fixture capacitance open correction” before measurement.
- When the open correction is executed once, **[OPEN]** is displayed on the front indicator of the instrument.
- Execute the fixture capacitance correction again after changing any of the contact check settings.

The channel switches to another in the order from CH1 through CH4 every time the **F1** key **[CH1234]** is pressed.

1 Connect the measurement fixture such as a measurement lead to the instrument.

Do not connect any objects to be measured to the measurement fixture.

Procedure to display the settings screen: (Measurement screen) **MENU** key >  **[C.CHK]** tab

2 Press the **F2** key **[EXEC]**.

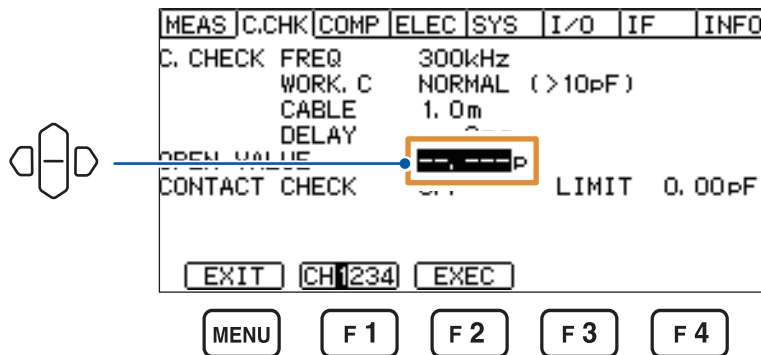

The open correction is executed, acquiring the correction value.

The data acquired by executing “fixture capacitance open correction” is saved even after the instrument is turned off.

A capacitance of between 0.000 pF and 99.999 pF can be corrected.

3 Press the **F2** key **[OK]**.

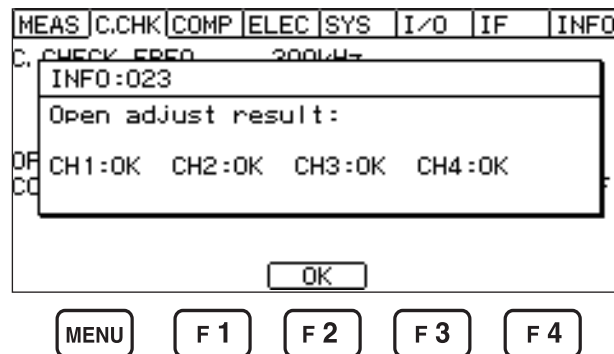

A short-circuit between the INPUT and OUTPUT terminals will cause the fixture capacitance open correction to fail, displaying a result “NG.” Check a short-circuit between the terminals.

4.7 Contact Check (Executing Contact Check, Setting Reference Value)

Be sure to read “Before performing a measurement” (p. 11) beforehand.

The contact check can be performed with the cable connected to the object to be measured. The instrument judges the contact check result to be pass or fail by detecting a difference of the capacitance between that obtained when the cable is open and that obtained during the contact check.

Judgment if the contact check function is set to ON

If the contact check function setting is set to **[ON]**, the indicator **[C.CHK]** will be displayed on the measurement screen.

Pressing the **F2** key **[C.CHK]** on the measurement screen or the **F2** key **[EXEC]** on the contact check setting screen executes the contact check once.

The contact check also starts at the start of measurement.

The contact check measures a capacitance by applying a high-frequency signal and determines the connection condition based on a difference between the measured capacitance and that measured with the terminals open.

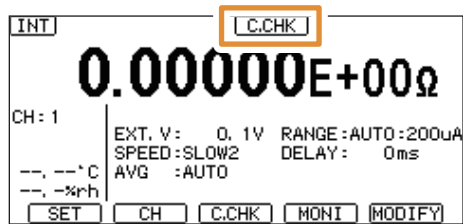

Resistance value measurement mode
(initial screen)

If the contact check function is set to **[ON]**, always execute “fixture capacitance open correction” before measurement.

If the capacitance value of the measurement system is less than the contact check reference value (contact error), **[C.CHK]** highlighted in reverse video (no object is connected to the instrument). In this case, inspect the instrument and the measurement fixture.

Measurement is completed and data is output normally even if a contact error occurs.

The instrument uses the system of detecting electrostatic capacitance. Hence it cannot be used for purely resistive objects that have less low capacitance components.

Procedure to display the settings screen: (Measurement screen) **MENU** key >  **[C.CHK]** tab

The channel switches to another in the order from CH1 through CH4 every time the **F1** key **[CH1234]** is pressed.

1 Select whether to perform contact check or not.

[ON] Enabled (The contact check is executed before starting measurement.)

[OFF] Disabled (default setting)

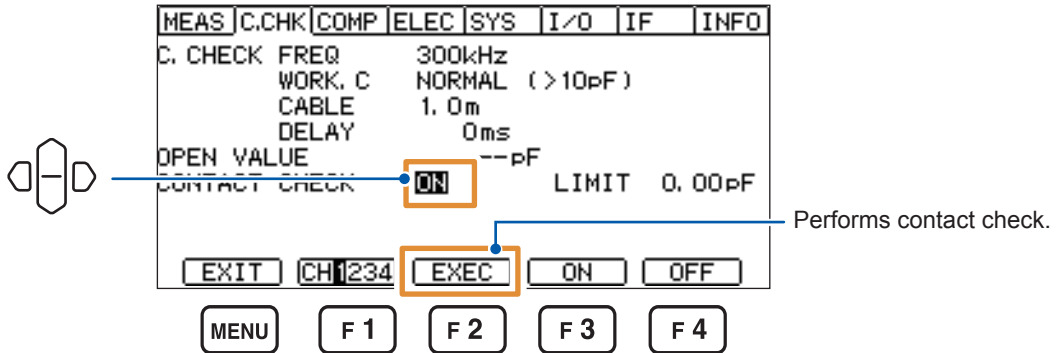

Performs contact check.

2 Set the capacitance reference value for judgment.

Set the minimum capacitance value for measurement objects.

Judgments are delivered by comparing measured values to this reference value.

A contact error occurs if the capacitance is less than this value.

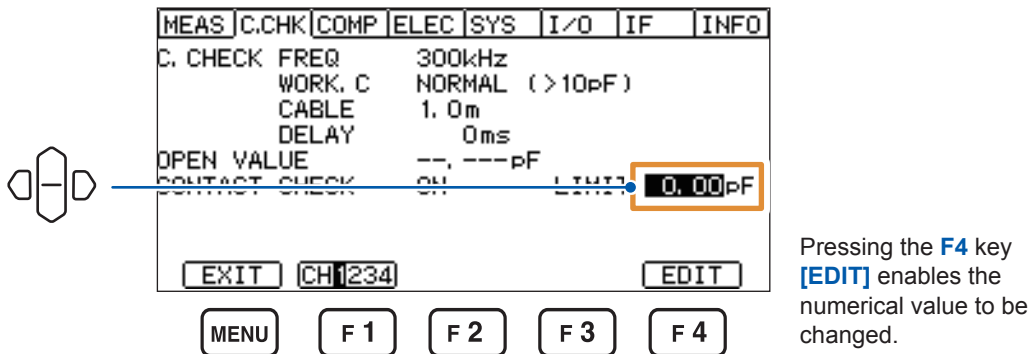

Pressing the **F4** key **[EDIT]** enables the numerical value to be changed.

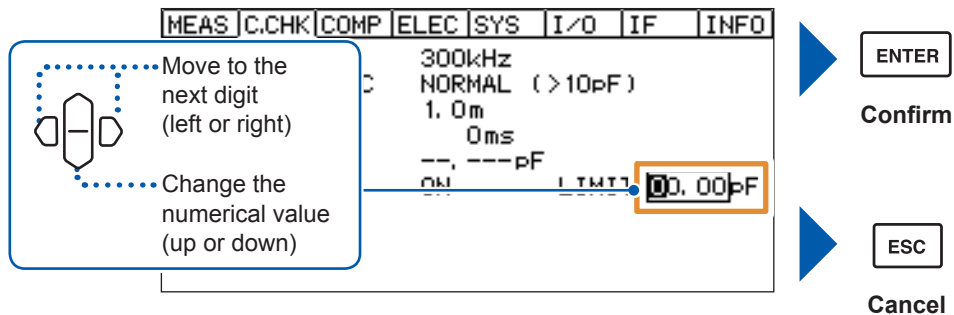

Move to the next digit (left or right)

Change the numerical value (up or down)

ENTER
Confirm

ESC
Cancel

The numerical value can also be changed with the numeric keypad. See “Methods for changing numerical values” (p. 25).

4.8 Setting Resistivity Calculation (Resistivity Measurement Function)

Use of an electrode conforming to JIS or other standards enables the instrument to directly calculate the surface resistivity and volume resistivity from the measured resistance.

Set the measured value display mode to **[RS]** (surface resistivity), **[RV]** (volume resistivity), or **[RL]** (liquid volume resistivity).

See “3.1 Setting Measured Value Display Mode” (p. 33).

Examples of electrodes and connection points for measurement to distinguish between volume resistivity and surface resistivity are given below.

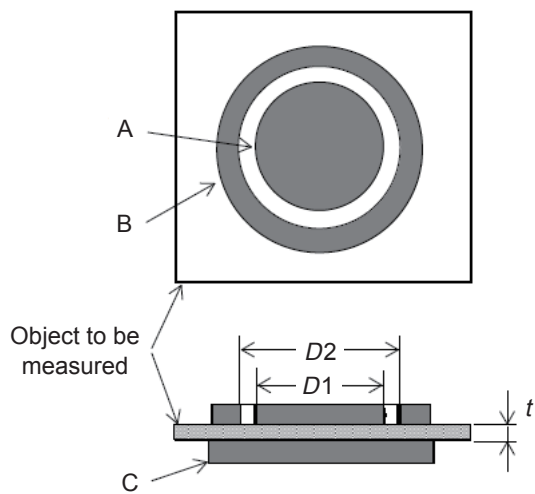

(1) Example of electrodes

	Volume resistivity	Surface resistivity
A	Main electrode	Main electrode
B	Guard electrode	Counter electrode
C	Counter electrode	Guard electrode

(2) Access point

Main electrode: INPUT terminal

Guard electrode: COM terminal

Counter electrode: OUTPUT terminal of the external power supply

The product of the measured volume resistance and the electrode constant is called volume resistivity (ρ_V), while the product of the surface resistance and the electrode constant is called surface resistivity (ρ_S).

See “Calculation formula” (p. 127) in the specifications for information on the calculation formulas.

Procedure to display the settings screen: (Measurement screen) **MENU** key >  **[ELEC]** tab

The channel switches to another in the order from CH1 through CH4 every time the **F1** key **[CH1234]** is pressed.

Select whether to set the model name of the option or to directly enter the electrode constant.

[OPTION] If the option connected to the instrument is selected, the numerical value is set automatically.

[EDIT] Set optional numerical values.

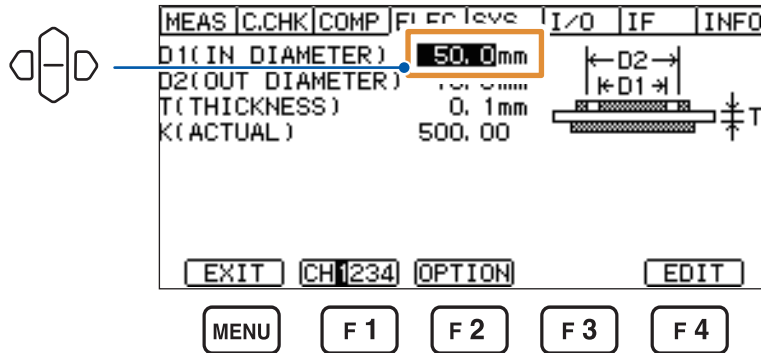

If **[OPTION]** is selected

Press the **F3** key **[↓]** or **F4** key **[↑]** to select an option.

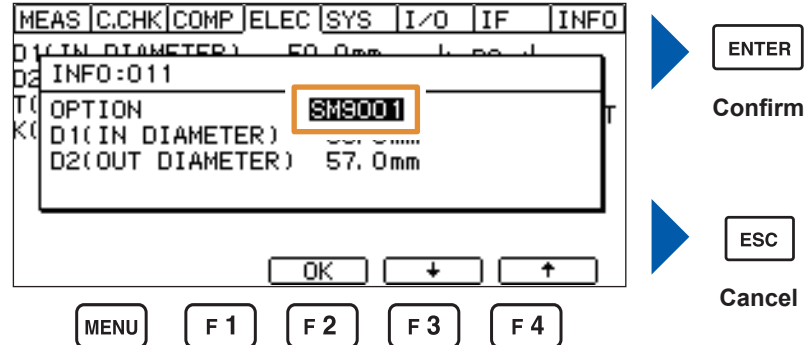

Options	Main electrode (D1)	Counter electrode (D2)
SM9001	φ30.5 mm	φ57.0 mm
SME-8301	φ30.0 mm	φ34.0 mm
SME-8310	φ50.0 mm	φ70.0 mm
SME-8311	φ19.6 mm	φ24.1 mm
SME-8320	φ50.0 mm	φ70.0 mm

If [EDIT] is selected

The numerical value can also be changed with the numeric keypad. See “Methods for changing numerical values” (p. 25).

1 Set the diameter of the main electrode (D1).

0.0 mm to 100.0 mm (Can be set in increments of 0.1 mm, default setting: 50.0 mm)

MEAS | C.CHK | COMP | File level | I/O | IF | INFO

D1 (IN DIAMETER) 50.0mm

0.1mm

500.00

← D2 →

← D1 →

T

ENTER

Confirm

ESC

Cancel

Move to the next digit (left or right)

Change the numerical value (up or down)

2 Set the inner diameter of the counter electrode (D2).

0.0 mm to 100.0 mm (Can be set in increments of 0.1 mm, default setting: 70.0 mm)

MEAS | C.CHK | COMP | ELEC | SYS | I/O | IF | INFO

D1 (IN DIAMETER) 50.0mm

D2 (OUT DIAMETER) 70.0mm

500.00

← D2 →

← D1 →

T

ENTER

Confirm

ESC

Cancel

Move to the next digit (left or right)

Change the numerical value (up or down)

3 Set the thickness (t) of the objects to be measured.

0.0 mm to 100.0 mm (Can be set in increments of 0.1 mm, default setting: 0.1 mm)

MEAS | C.CHK | COMP | ELEC | SYS | I/O | IF | INFO

D1 (IN DIAMETER) 50.0mm

D2 (OUT DIAMETER) 70.0mm

T (THICKNESS) 00.1mm

500.00

← D2 →

← D1 →

T

ENTER

Confirm

ESC

Cancel

Move to the next digit (left or right)

Change the numerical value (up or down)

4 Set the electrode constant (K).

0.01 to 999.99 (Can be set in increments of 0.01, default setting: 500.00)

MEAS	C.CHK	COMP	ELEC	SYS	I/O	IF	INFO
D1(IN DIAMETER)			50.0mm			←D2→	
D2(OUT DIAMETER)			70.0mm			←D1→	
T(THICKNESS)							T
K(ACTUAL)			500.00				

Move to the next digit (left or right)
 Change the numerical value (up or down)

ENTER Confirm
 ESC Cancel

4.9 Further Accelerating Measurement (Function of Updating Drawing During Measurement)

Usually, measured values displayed on the screen are updated every time a measurement completes. In this case, you need to wait for some time until the screen is updated after the completion of the measurement (the EOM is output) to when the next TRIG is accepted. Set this function setting to **[OFF]** to increase the measurement speed by omitting the update of the measured value display.

Procedure to display the settings screen: (Measurement screen) **MENU** key > **[MEAS]** tab

- [ON]** Updates the measured value display for every measurement (default setting).
- [OFF]** Does not update the measured value display (Updates the display when the setting is changed).

MEAS	C.CHK	COMP	ELEC	SYS	I/O	IF	INFO
MEAS FORMAT							DIGIT 6
DISP UPDATE			ON				
TRIGGER			INTERNAL				
SELF CALIBRATION			ON				600s

EXIT ON OFF

MENU F1 F2 F3 F4

Measurement Methods Suitable for Various Objects to Be Measured

Insulation resistance objects to be measured vary in material, shape, electrical characteristics, and other properties, and the suitable insulation resistance measurement method varies depending on the object.

This chapter describes suitable insulation resistance measurement methods for different objects.

5.1 Measuring Components of Circuits

Measurement principle

Generally, insulation resistance is measured by measuring the current that flows from a terminal through a measured object to another terminal, and converting the result into a resistance value. To measure only the current that flows through the measured object, the current that does not flow through the object (e.g., current that flows through the insulator of the object holder) must be diverted to the GUARD terminal (on the common side of the current measurement block) so that it does not flow into the INPUT terminal. That is, “guarding” is to make the current flowing through the outside of the measured object directly flow to the common side to prevent it from flowing into the INPUT terminal.

If you use a measurement fixture, generally the component holder of the fixture must be guarded. However, measuring the insulation resistance of the fixture in addition to that of the measured object may not be a problem if the insulation resistance of the fixture is much, for example, hundredfold or more, higher than that of the object.

Although the structure of an actual fixture may vary depending on the shape of the object to be measured, the guard circuit must be configured in such a way that the current not flowing through the object is diverted to the GUARD.

Measurement with use of a measurement fixture

Design the circuit in the order that the currents flowing through the outside of all the objects to be measured flow through the guard circuit and connect the guard circuit to the GUARD terminal of the instrument.

Example of use: (Use a measurement fixture with a guard installed)

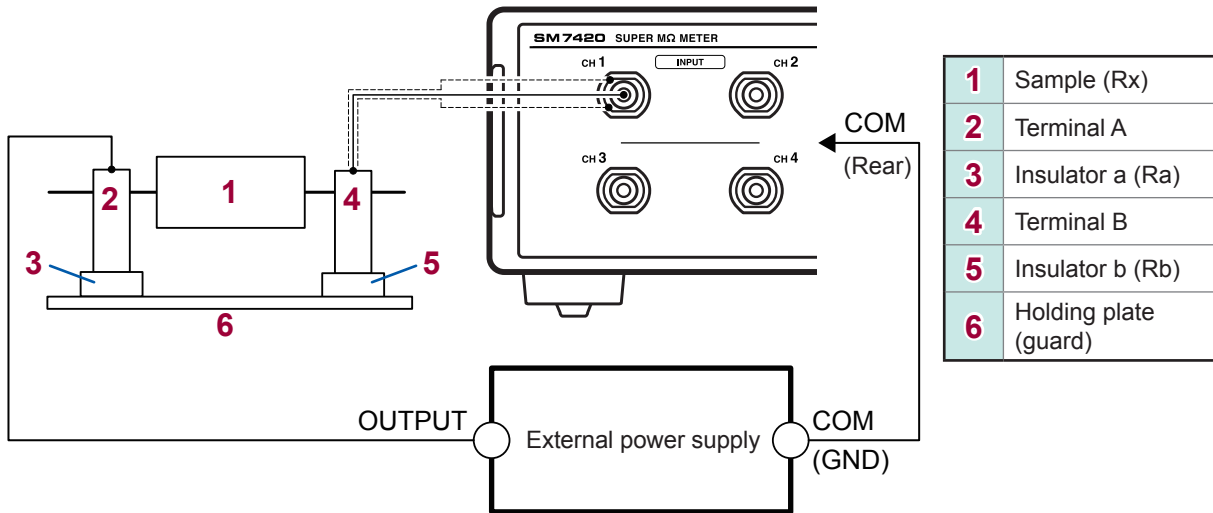

Principle of the guard

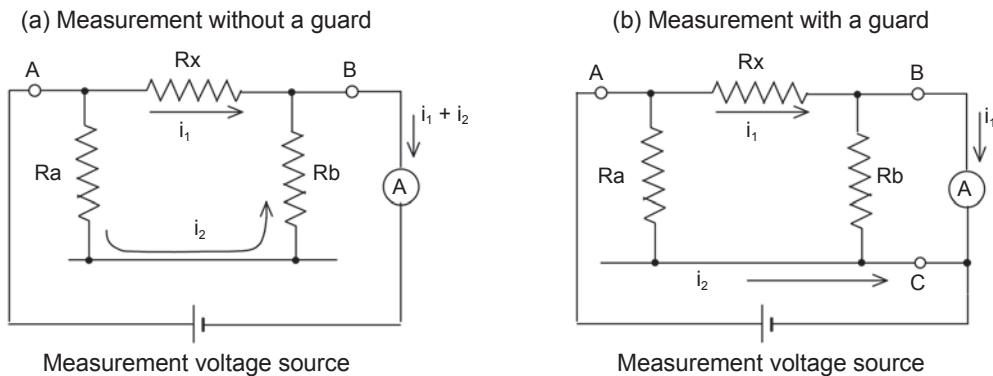

The figures “Example of use” and “Principles of the guard” explain the effectiveness of the guard. Considering how the current flows from Terminal A to Terminal B in the “Example of use,” 2 flow channels are found.

- Current pathway passing through the measured object (Rx)
- Current pathway passing through in the following order: Insulator a (Ra), holding plate, Insulator b (Rb), and Terminal B.

Connect Terminal A to the OUTPUT terminal of the external power supply and Terminal B to the INPUT terminal of the instrument, and then start the measurement. Thus, the sum of the insulation resistance (Rx) of the measured object, the current that flows through the insulation resistance Ra of Insulator a, and the current that flows through the insulation resistance Rb of Insulator b is measured. “Principle of the guard” shows the equivalent circuit of this case.

As you can clearly see from the equivalent circuit in “(a) Measurement without a guard,” both the current i_1 , which flows through the measured object, and the current i_2 , which flows through Insulators a and b, flow into the input circuit through Terminal B.

Next, use a metal plate as the holding plate of the holder, and connect it to the COM terminal of the instrument. This ensures that only the current flowing through the measured object flows into the INPUT terminal; the current that flows through Insulators a and b is excluded. (See “(b) Measurement with a guard.”)

This equivalent circuit shows that the current i_2 , which flows through Insulator a, does not flow into the input circuit, but directly flows into the common current measurement block, and that only current i_1 , which flows through the measured object, flows into the input circuit.

Measurement without use of a measurement fixture

Connect the optional Pin Type Lead or Clip Type Lead to the object to be measured and perform measurement.

Both the measuring leads do not have a guard on the end connected to the power supply terminal but have a guard on the other end connected to the INPUT terminal.

Pin Type Lead	The structure of the lead is designed to guard the test rods also, so that you can measure while holding the test rods in your hands.
Clip Type Lead	The clip parts have no guard, connect them to the terminals of the object to be measured object and perform measurement keeping your hands away from them.

See “2.2 Connecting Measurement Leads to Instrument” (p. 28) and “3.5 Connecting Measurement Leads or Electrode to Object to Be Measured” (p. 38).

The insulation resistance value varies depending on the insulation material. However, the measurement time, measurement voltage, and temperature also have a significant impact on the measured value.

Impact of the measurement time

A circuit of an insulator is schematically considered as a complex circuit in which resistance and capacitance are included serially or parallel; thus, applying a voltage to the insulator results in the dielectric absorption current and leakage current equivalent to the charging current flowing.

The insulation resistance can be obtained by measuring the leakage current and converting it into a resistance value. Generally, the dielectric absorption current is considerably larger than the leakage current, and the time constant may also be very large depending on the type of the insulator. Therefore, in some cases, it may take a long time for the dielectric absorption current to become smaller than the leakage current. If a resistant value of such an insulator is measured, measuring for a short time results in a small insulation resistance value; the longer the measurement time, the higher will be the insulation resistance value.

Impact of measurement voltage

The time constant and insulation resistance value of the dielectric absorption current may considerably vary depending on the voltage applied to the insulator. Generally, the higher the measurement voltage, the lower will be the insulation resistance value.

Impact of temperature

Temperature also has an impact on insulation resistance values. Although they will vary depending on the type of the insulator, generally the higher the temperature, the lower will be the insulation resistance. Accurate insulation resistance not only it takes time, but also it is difficult to measure.

In some cases, you cannot freely determine the measurement voltage due to the dielectric strength of the object to be measured. However, a measurement time value of 1 minute is used, and 1-minute insulation resistance value is expressed with the measurement voltage as, for example, “1000 M Ω at a voltage of 500 V DC.”

To compare the insulation resistance, you must determine the measurement voltage and time to perform measurement. However, it may be important to reduce the measurement time (or inspection time) in a production process. In such cases, it is important to determine the time in the range that allows correlation with the 1-minute value.

Automatic measurement

If you have many objects or points to be measured, “automatic measurement” is useful. The function performs measurement by automatically switching objects, measurement fixtures, or measurement terminals to be measured.

For automatic measurement, the switch timing must be aligned with the instrument operation. The following are the 2 methods to align the timing.

<p>When switching objects to be measured according to the INDEX signal output from Pin 29 of the instrument’s EXT I/O terminal</p>	<ul style="list-style-type: none"> • Set the trigger mode of the instrument to Internal trigger mode or External trigger mode. <p>Internal trigger mode</p> <ul style="list-style-type: none"> • When the START key is pressed, measurement starts. <p>External trigger mode</p> <ul style="list-style-type: none"> • After the START key is pressed, when a manual trigger is input, measurement starts.
<p>When a trigger pulse is input to Pin 1 of the EXT I/O terminal of the instrument at the timing of switching the objects to be measured</p>	<ul style="list-style-type: none"> • Set the trigger mode of the instrument to External trigger mode. • After the START key is pressed, when a trigger pulse is input to Pin 1 of the instrument’s EXT I/O terminal, measurement starts. • The conditions of the external trigger signal are as follows: <ul style="list-style-type: none"> • Pulse width: 100 μs or greater • Drive output: Open collector or TTL output • Drive current: 1 mA or higher sink current

For details, see the following pages:

Trigger mode: “4.3 Changing Measurement Starting Conditions (Trigger Function)” (p. 46)

EXT I/O terminal: “9 External Control (EXT I/O)” (p. 89)

5.2 Measuring Flat Sample

Measuring insulation resistance of an object with no terminals installed requires something that can function as terminals to be attached on the object.

The measurement method varies depending on the type of the terminal.

What function as terminals

It must be possible to switch the objects to be measured easily. Therefore, items with a structure that allows them to function as terminals just by contacting the object is often used.

The terminals used for measurement must have proper contact with the object to be measured without any loose connection.

For a solid insulation material, the method of bringing terminals (electrode) that have a specific pin shape or those with smooth flat surfaces, which can contact with smooth surfaces of objects to be measured without any space between them, into close contact with the objects to be measured is employed to measure insulation resistance. (The shape and structure of the terminals varies depending on the shape and characteristics of the objects to be measured.)

Measurement using pin type terminals

Insulation resistance is classified into “volume resistance,” which is the current flowing through the measured object and “surface resistance,” which is the current flowing along the surface of the sample. To measure both of them together, use pin type terminals.

Example of pin creation

Make 2 holes (such as tapered holes) with a predefined diameter at a certain interval on the flat sample. Apply material with relatively low insulation resistance, such as petroleum jelly, to the pins and insert the pins into the holes to use them as terminals for measurement.

These pins are of a simple structure and provide relatively steady contacts, eliminating the need for smoothing the surface of the sample to obtain a flat surface.

Setting the instrument

Press the **MODE** key to switch the measurement mode to resistance value measurement mode, and then perform measurement. (p. 33)

Measurement using an electrode for measuring surface resistance

The electrode for measuring surface resistance is used as terminals for measurement by pressing it on the surface of the object to be measured. It provides an easy method to perform measurement if the objects to be measured are relatively soft.

This electrode cannot exactly separate the volume resistance but can essentially measure the surface resistance because it is generally lower.

In particular, this method is useful for objects to be measured that have been subjected to surface anti-static treatment.

Setting the instrument

Press the **MODE** key to switch the measurement mode to surface resistivity mode, and then perform measurement. (p. 33)

Measurement using an electrode for a flat sample

The “volume resistance” and “surface resistance” must be measured separately because their properties are different from each other.

To compare different insulating materials in terms of insulation resistance, the insulating material-specific resistance values that are not affected by the shape of the terminal are required. They are considered to be the volume resistivity or surface resistivity. Use an electrode (such as optional Model SME-8310 or SME-8311) to determine the volume resistance value or the surface resistance value. Then, multiply the values by each of the electrode constants to calculate the volume resistance value or the surface resistivity. The instrument can automatically calculate the volume resistivity or the surface resistivity.

Setting the instrument

Settings for calculating the resistivity are required.

See “4.8 Setting Resistivity Calculation (Resistivity Measurement Function)” (p. 55).

Press the **MODE** key to switch the measurement mode to volume resistivity measurement mode, and then perform measurement. (p. 33)

Volume resistance measurement and surface resistivity measurement (the functional role of the guard electrode)

A guard is required for measuring volume resistance and surface resistivity.

Hioki provides Model SME-8310 Plate Sample Electrode and SME-8311 Electrodes for Flat Sample as options.

Both devices consists of 3 electrodes: “main electrode,” “counter electrode,” and “guard electrode.”

Because measurement using Model SME-8301 Surface Resistance Measurement Electrode is equivalent to the measurement described in “Surface resistance measurement (1) Measurement without the guard electrode (p. 65),” it cannot provide accurate surface resistance measurement.

Volume resistance measurement

(1) Measurement without the guard electrode

Because the current flowing along the surface of the measured object is also measured unnecessarily, the current flowing across the object in the thickness direction cannot be separately measured.

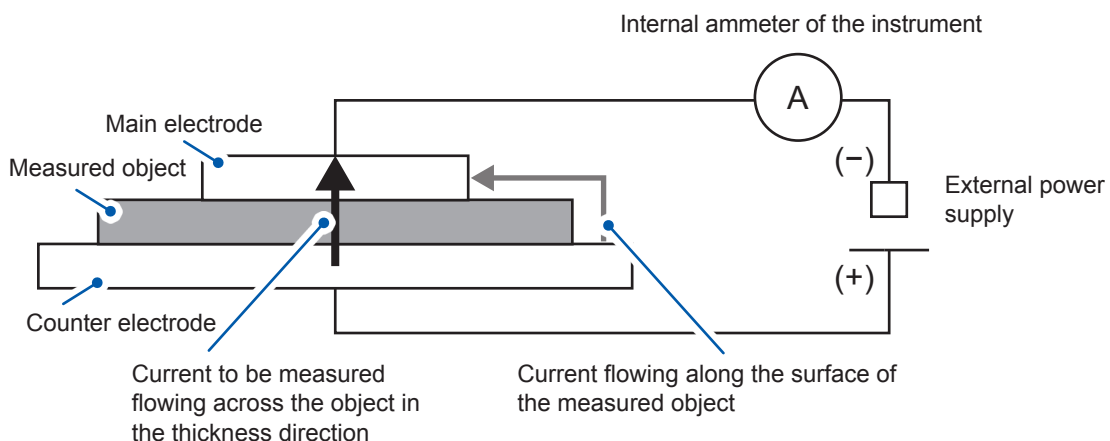

(2) Measurement with the guard electrode

Because the current flowing along the surface of the measured object flows out through the guard electrode to the external power supply, the current flowing across the object in the thickness direction can be separately measured with accuracy.

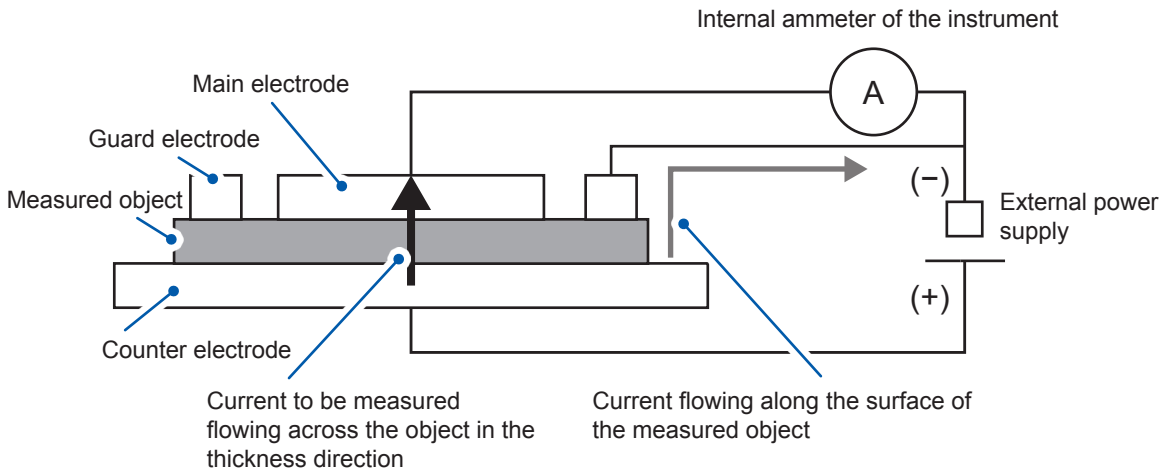

Surface resistance measurement

(1) Measurement without the guard electrode (also applicable to measurement with use of Model SME-8301)

Because the current flowing through the measured object and the other current flowing through the base (insulator) are also measured unnecessarily, the current flowing along the surface cannot be separately measured.

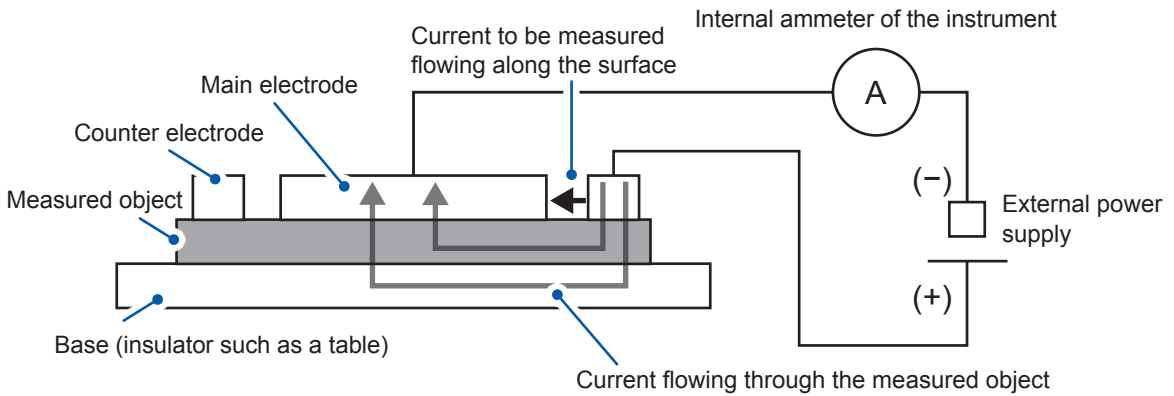

(2) Measurement with the guard electrode

Because the current flowing through the measured object flows out through the guard electrode to the external power supply, the current flowing along the surface of the measured object can be separately measured with accuracy.

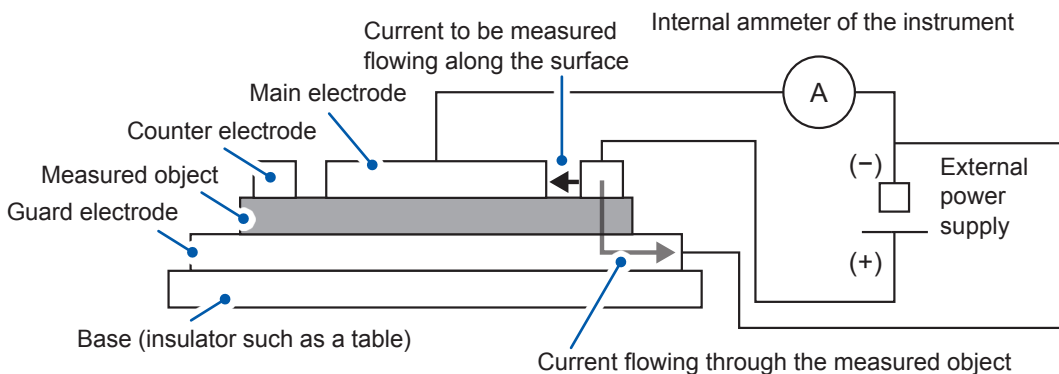

5.3 Measuring a Liquid Sample

To measure the volume resistance of a liquid sample, insert an electrode with a fixed shape in the liquid sample or use an electrode that can also function as the container for the liquid sample.

When using an electrode for liquid samples

Example of connection

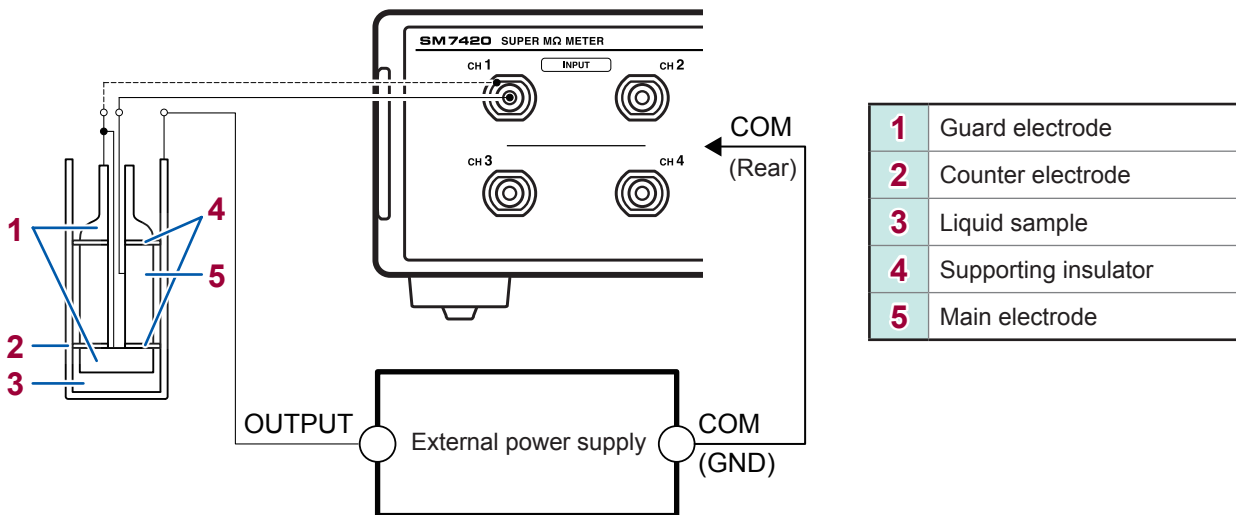

Setting the instrument

Settings for calculating the resistivity are required.

See “4.8 Setting Resistivity Calculation (Resistivity Measurement Function)” (p. 55).

Press the **MODE** key to switch the mode to liquid volume resistivity measurement mode, and then perform measurement. (p. 33)

For the electrode constant, refer to the Instruction Manual of the electrode for liquid samples.

5.4 Measurement With Use of Shielding Box

Be sure to read “Before using the shielding box” (p. 11) beforehand.

Measurement of high insulation resistance, which requires to measure current with high-sensitivity, may be unstable due to ambient noise or inductive current.

Thus, measurement objects to be measured must be placed in a shielding box.

Example of connection

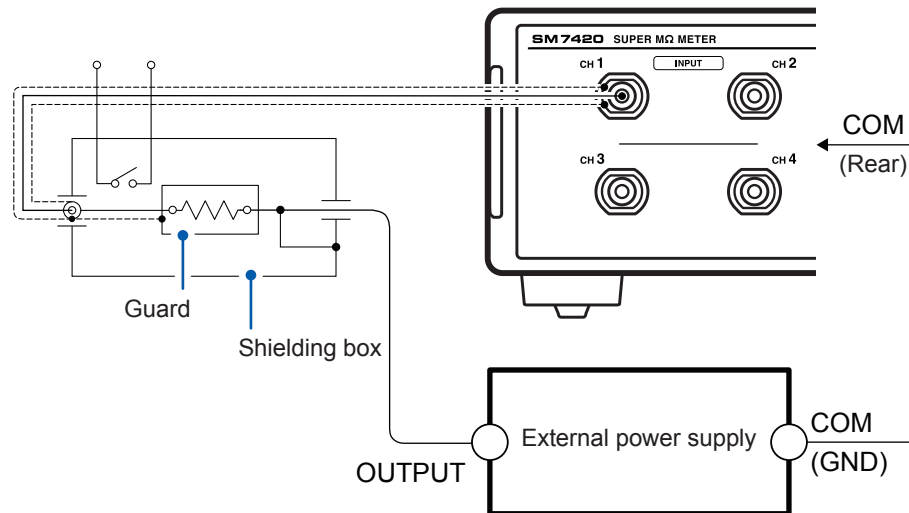

Model SME-8350 Shielding Box is provided as an option.

Setting the instrument

For the measurement using a shielding box, set the measured value display mode according to the objects to be measured.

See “5.1 Measuring Components of Circuits” (p. 59), “5.3 Measuring a Liquid Sample” (p. 66) and “5.2 Measuring Flat Sample” (p. 63).

5.5 Measuring Current

Connection method

- 1** Connect the positive side of the object to be measured to the OUTPUT terminal of the external power supply.
- 2** Connect the negative side of the object to be measured to the INPUT terminal of the instrument.

Use a shielded wire for the measurement lead connected to the INPUT terminal so that it is not affected by inductive interference such as noise.

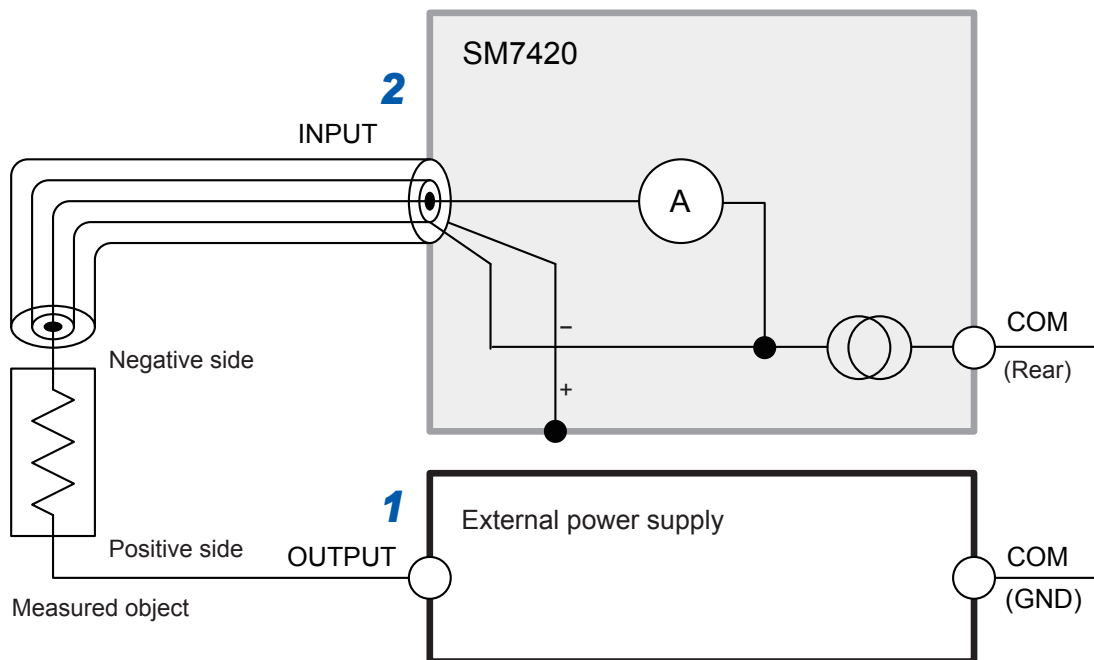

Setting the instrument

Press the **MODE** key to switch the measurement mode to current value measurement mode, and then perform measurement. (p. 33)

6

Judging Measured Value (Comparator Function)

The comparator function judges whether measured values are within or out of a range defined by an upper and lower limits set previously.

The judgment is displayed as follows on the screen.

[Hi]	(Upper limit) < (Measured value)
[IN]	(Lower limit) ≤ (Measured value) ≤ (Upper limit)
[Lo]	(Measured value) < (Lower limit)

Upper and lower limit values

The function judges whether the measured value is higher than the upper limit previously set (Hi), within the range between the lower and upper limits previously set (IN), or lower than the lower limit previously set (Lo).

(Example: For upper limit is 3 GΩ, lower limit is 2 GΩ, measured value is 1.5 GΩ)

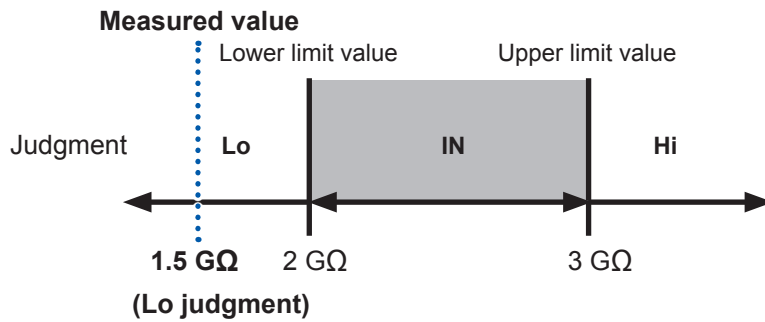

Procedure to display the settings screen: **COMP** key

The channel switches to another in the order from CH1 through CH4 every time the **F1** key [CH1234] is pressed.

1 Select whether the measured value is to be judged or not.

(UPPER LIMIT: Upper limit, LOWER LIMIT: Lower limit)

- [ON] Yes
- [OFF] No (default setting)

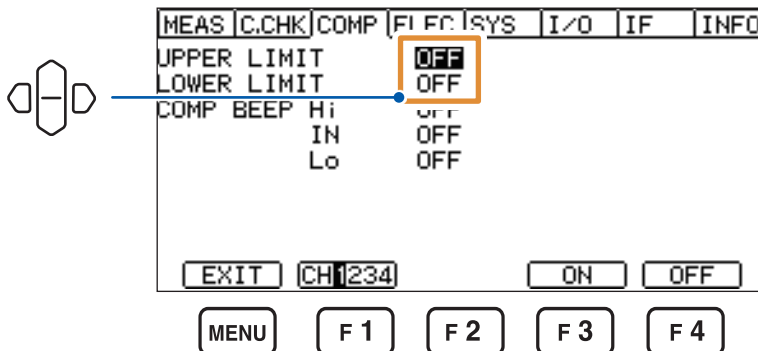

2 If the upper limit and lower limit settings are set to [ON], set the numerical value.

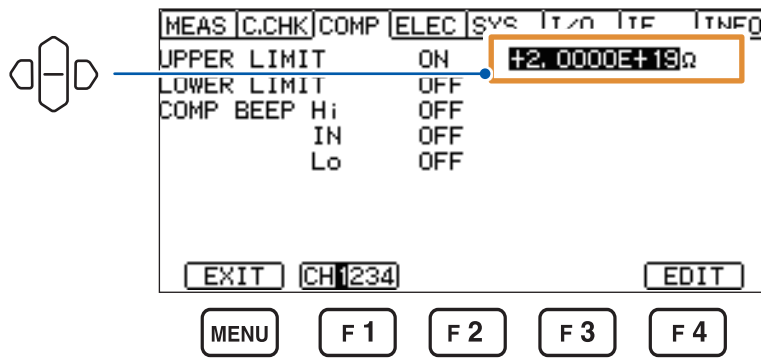

Pressing the **F4** key [**EDIT**] enables the numerical value to be changed.

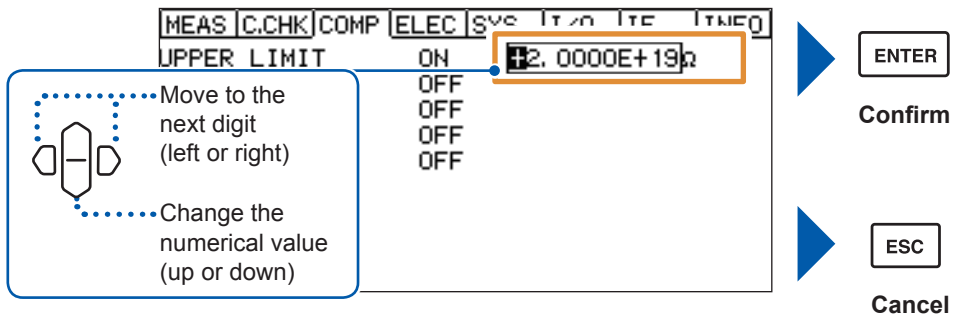

The numerical value can also be changed with the numeric keypad. See “Methods for changing numerical values” (p. 25).

Settable range

The following ranges are applicable in common to all ranges.

Resistance value measurement mode	2.0000E+19 Ω to 5.0000E+01 Ω
Current value measurement mode	-1.99999E-03 A to 1.99999E-03 A
Surface resistivity measurement mode	2.0000E+21 Ω to 5.0000E+03 Ω
Volume resistivity measurement mode	
Liquid volume resistivity measurement mode	

6.1 Setting Judgment Sound

Select whether to use a judgment sound for the measurement results.

Procedure to display the settings screen: **COMP** key

1 Select the respective buzzer sounds for Hi judgment, IN judgment, and Lo judgment.

[OFF] (No sound, default setting), [TYPE1], [TYPE2], [TYPE3]

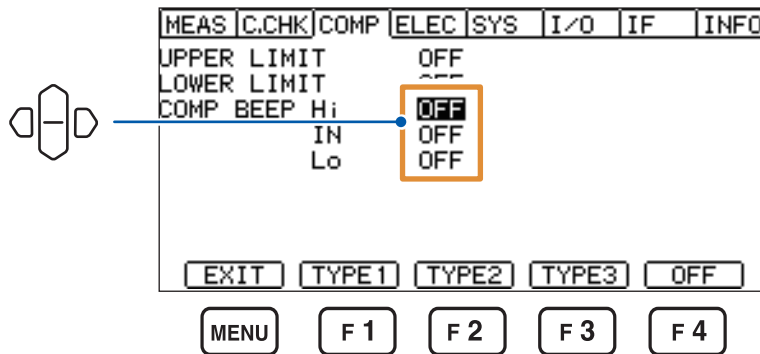

Selecting [TYPE1], [TYPE2], or [TYPE3] sounds the buzzer in a specific tone for confirmation.

2 Set the number of beeps if you need the buzzer sound.

1 to 5 times, continuous (default setting: 1 time)

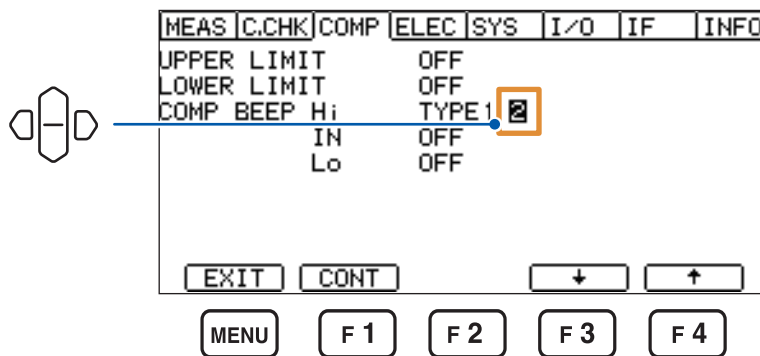

Press the **F3** key [↓] or **F4** key [↑] to change the number of times.
Press the **F1** key [CONT] to use the continuous sound setting.

6.2 Confirming Judgment Results

An indicator appears on the measurement screen according to the judgment results.
 The instrument outputs judgment results through the EXT I/O connector.
 The On signal corresponding with a judgment result is outputted.

IN	If the measured value is smaller than the upper limit value but greater than the lower limit value that are previously set
Hi	If the measured value is greater than the upper limit value that is previously set
Lo	If the measured value is smaller than the lower limit value that is previously set

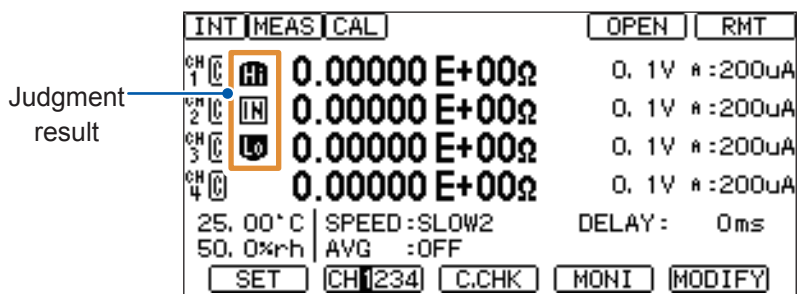

Measurement result	Judgment result	Output of EXT I/O			
		HI	IN	LO	ERR
(Upper limit) < (Measured value)	Hi	ON	OFF	OFF	OFF
(Lower limit) ≤ (Measured value) ≤ (Upper limit)	IN	OFF	ON	OFF	OFF
(Measured value) < (Lower limit)	Lo	OFF	OFF	ON	OFF
Current Over Range	Hi	ON	OFF	OFF	OFF
Measurement error*	No judgment	OFF	OFF	OFF	ON
During interruption of measurement	No judgment	OFF	OFF	OFF	OFF

* The following instances results in measurement error:

- The A/D converter for measurement and that for voltage measurement have overflowed.
- The contact check measured value is 99.999 pF or more.

7

Saving and Loading Settings (Panel Saving and Loading)

The present settings can be saved to the memory of the instrument (panel saving function).

The saved settings can be loaded from the memory by pressing the keys or sending communication commands (panel loading function).

The instrument can save a maximum of 50 settings. The saved settings are retained even when the instrument is turned off.

Setting items that can be saved with the panel saving

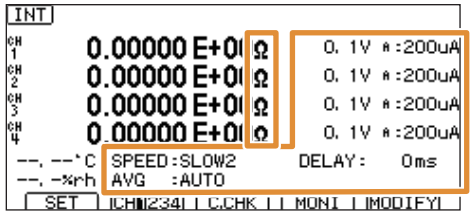
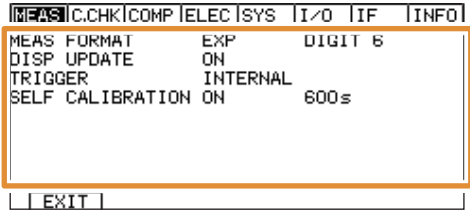
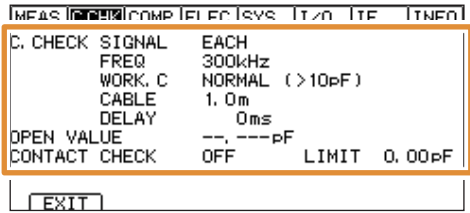
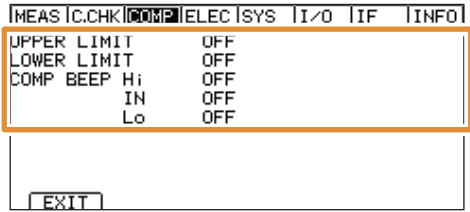
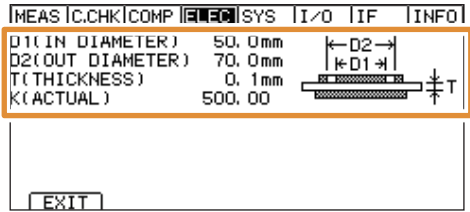
<p>Basic settings</p>		<ul style="list-style-type: none"> • Measured value display mode • Voltage value for resistance calculation • Measurement speed • Current range • Delay • Average
<p>[MEAS] settings</p>		<ul style="list-style-type: none"> • Display range • Displayed digit number • Function of updating and switching drawing during measurement • Trigger • Self-calibration
<p>[C.CHK] settings</p>		<ul style="list-style-type: none"> • Fixture capacitance open correction • Contact check
<p>[COMP] settings</p>		<ul style="list-style-type: none"> • Upper and lower limit values of comparator • Judgment sound
<p>[ELEC] settings</p>		<ul style="list-style-type: none"> • Resistivity measurement settings

7.1 Saving Settings (Panel Saving Function)

This function saves the settings that are currently set.

Procedure to display the settings screen: **LOAD/SAVE** key

- 1 Select the panel number to be saved, and press the **F4** key [**SAVE**].

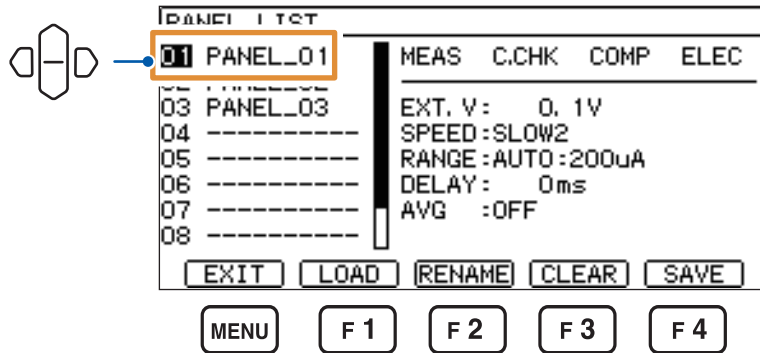

The confirmation dialog box is displayed.

(If saving it as a new one)

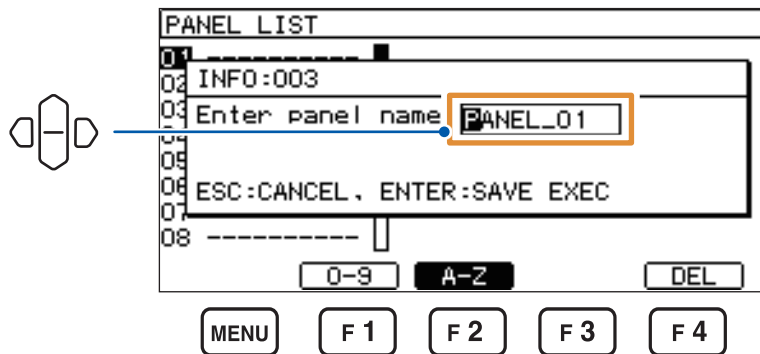

(If saving it, replacing the exist one with the new one with the same name)

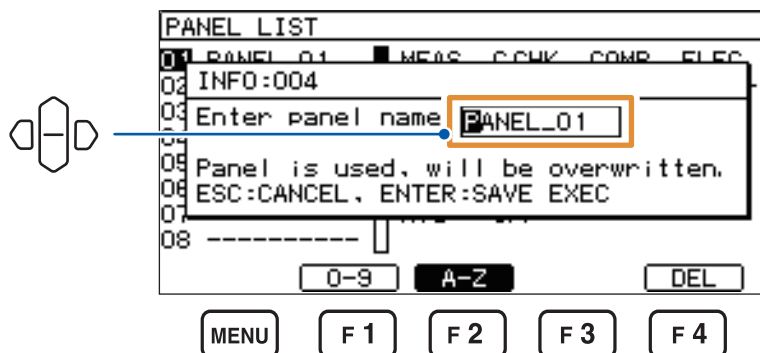

The panel name can be changed.

- F1** key [**0-9**] Numeric input mode is enabled. (Select a numerical value using the cursor.)
- F2** key [**A-Z**] Alphabetical character input mode is enabled. Underscores (**_**) can also be entered. (Select a character using the cursor.)
- F4** key [**DEL**] Deletes the characters one by one.

To cancel the save operation, press the **ESC** key.

- 2 Press the **ENTER** key.

The present settings are saved.

7.2 Loading Settings (Panel Loading Function)

This function loads the settings that are saved.

Procedure to display the settings screen: **LOAD/SAVE** key

- 1 Select the panel number to be loaded, and press the **F1** key [**LOAD**] or the **ENTER** key.

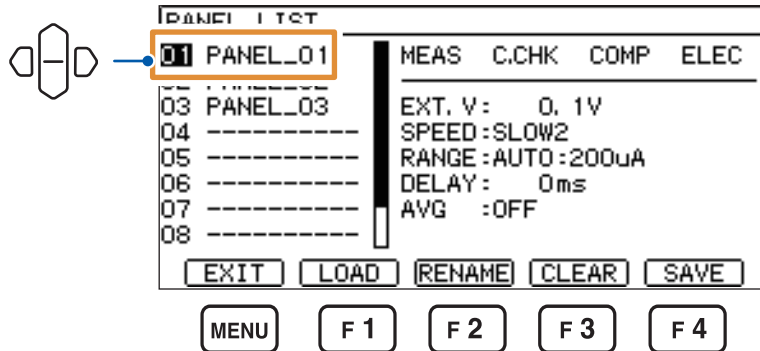

The confirmation dialog box is displayed.

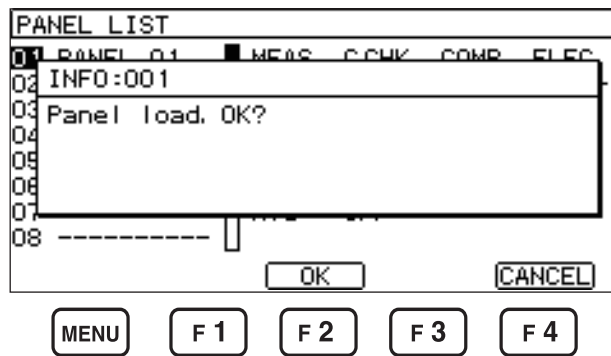

To cancel the load operation, press the **F4** key [**CANCEL**] or the **ESC** key.

- 2 Press the **F2** key [**OK**] or the **ENTER** key.

The present settings are replaced with the settings of the selected panel.

7.3 Changing Panel Name

The panel name can be changed.

Procedure to display the settings screen: **LOAD/SAVE** key

- 1 Select the number of the panel whose name you want to change, and press the **F2** key [**RENAME**].

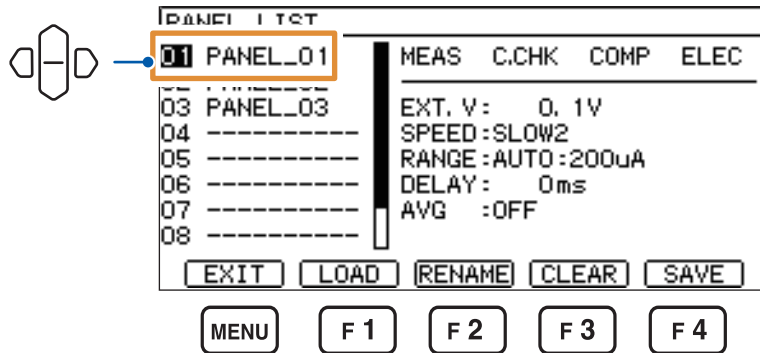

- 2 Change the panel name.

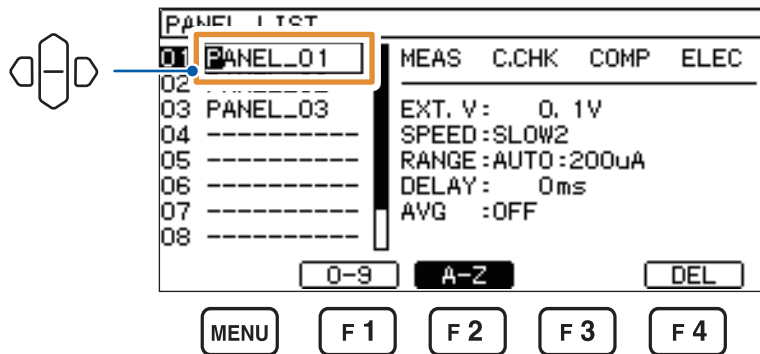

- F1** key [**0-9**] Numeric input mode is enabled. (Select a numerical value using the cursor.)
- F2** key [**A-Z**] Alphabetical character input mode is enabled. Underscores (`_`) can also be entered. (Select a character using the cursor.)
- F4** key [**DEL**] Deletes the characters one by one.

To cancel the change operation, press the **ESC** key.

- 3 Press the **ENTER** key.

The panel name is confirmed.

7.4 Deleting Panel Contents

This section describes the procedure for deleting saved settings.

Procedure to display the settings screen: **LOAD/SAVE** key

- 1 Select the panel number to be deleted, and press the **F3** key [**CLEAR**].

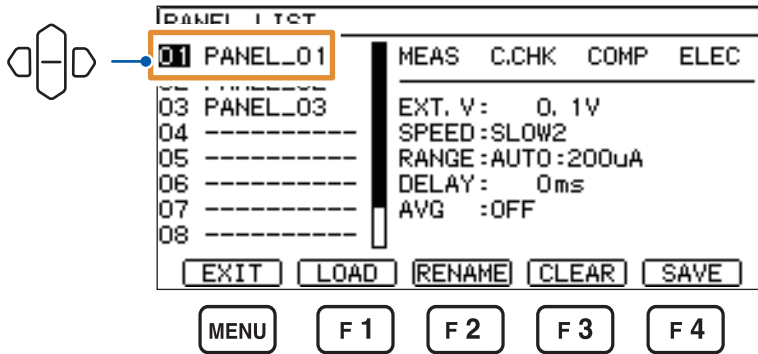

The confirmation dialog box is displayed.

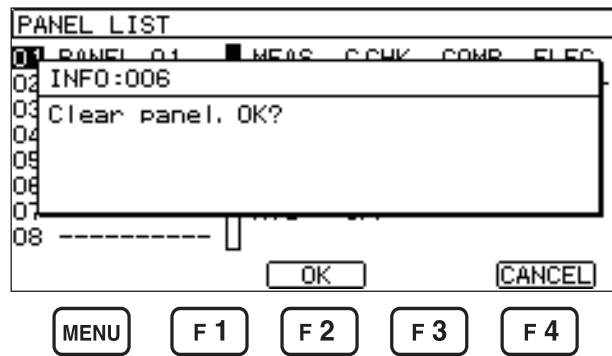

To cancel the delete operation, press the **F4** key [**CANCEL**] or the **ESC** key.

- 2 Press the **F2** key [**OK**] or the **ENTER** key.

The contents of the panel is deleted.

8 System Setting

8.1 Setting Sound of Key Operation

You can set the sound of key operation to be enabled or disabled.

Procedure to display the settings screen: (Measurement screen) **MENU** key >   **[SYS]** tab

- [ON]** The operation sound is emitted (default setting).
- [OFF]** The operation sound is not emitted.

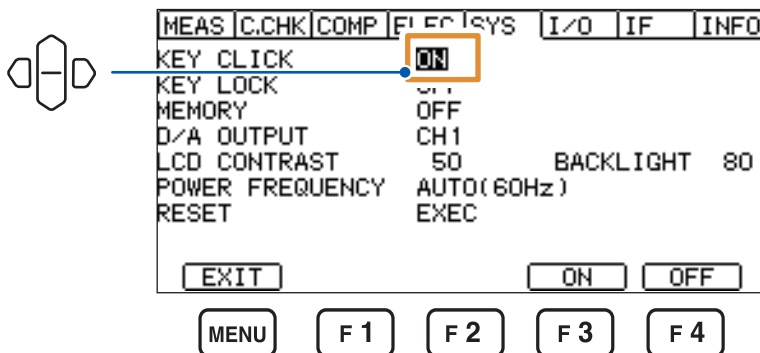

8.2 Disabling Key Operation (Key Lock Function)

You can disable the key operation.

Procedure to display the settings screen: (Measurement screen) **MENU** key >  **[SYS]** tab

1 Press **[ALL]** or **[MENU]** to disable the key operation (to activate the key lock function).

[ALL] Disables all of the key operation except the **MENU** key **[UNLOCK]**.

[MENU] Disables the following key operation:
COMP, **LOAD/SAVE**, and **MENU**

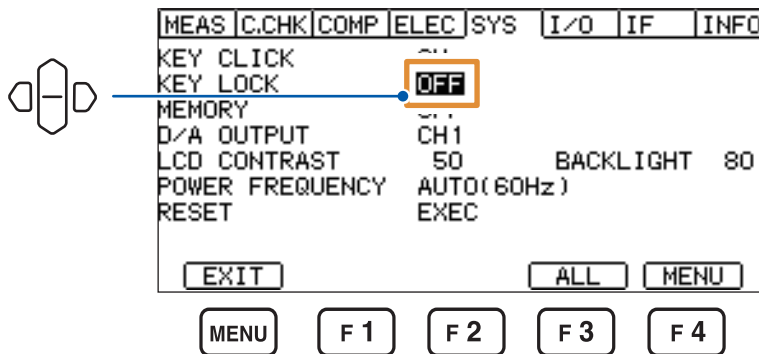

The confirmation dialog box is displayed.

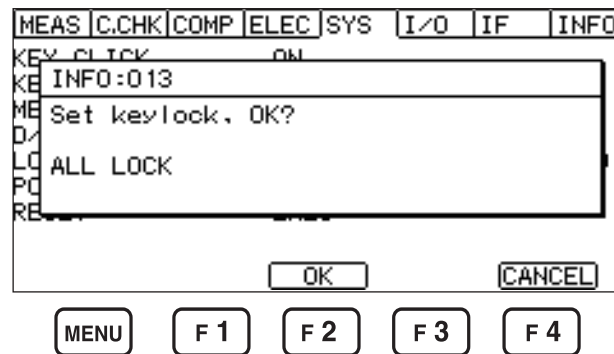

To cancel the key lock function to be activated, press the **F4** key **[CANCEL]** or the **ESC** key.

2 Press the **F2** key **[OK]**.

[K.LOCK] is displayed on the measurement screen, and the key operation is disabled.

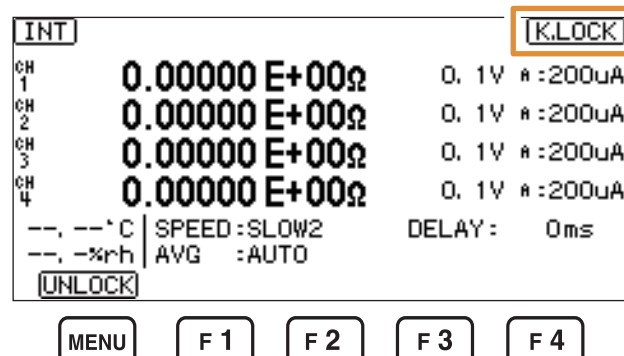

To unlock the key lock: hold the **MENU** key **[UNLOCK]** for more than 1 second.



Inputting the KEYLOCK signal disables all the key operation. (The key lock function cannot be deactivated by using the operation keys.)
 Key operation is disabled while the KEYLOCK signal state is on.
 Switching the signal to the off state deactivates the key lock function.

8.3 Browsing, Deleting, and Outputting Internal Memory Data

The memory function can automatically store up to 999 measured values in the internal memory of the instrument. The number of stored measured values reaching 999 disables further measured values to be stored.

Delete the memory data before you start re-saving the values.

You can browse the list of saved measured values, delete them, or acquire them by sending the communication command (:MEMory?).

Procedure to display the settings screen: (Measurement screen) **MENU** key >   **[SYS]** tab

Select whether to activate the memory function or not.

- [ON]** Activate the memory function.
- [OFF]** Deactivate the memory function. (default setting)

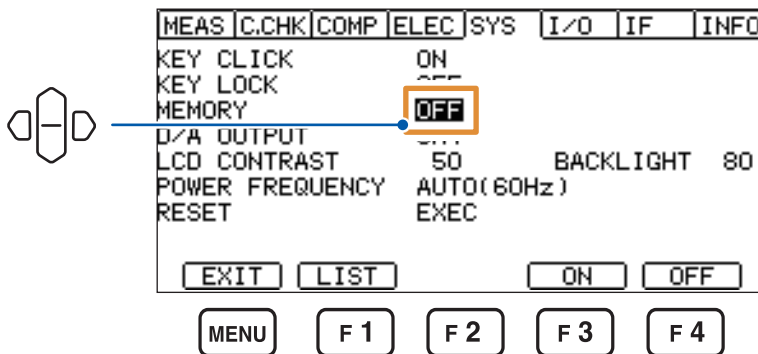

Browsing and deleting data

Procedure to display the screen: (Measurement screen) **MENU** key >   **[SYS]** tab

1 Press the **F1** key **[LIST]**.

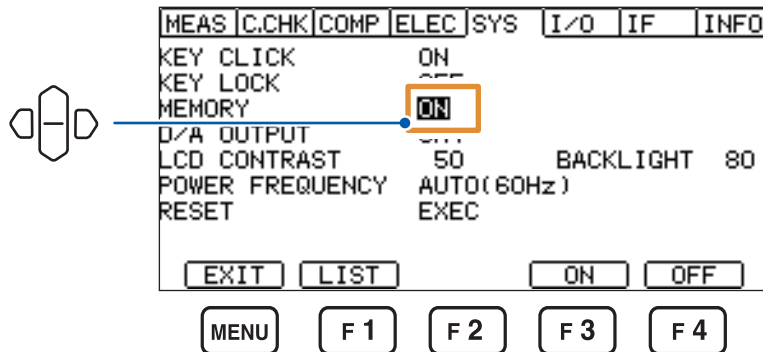

The internal memory list is displayed.

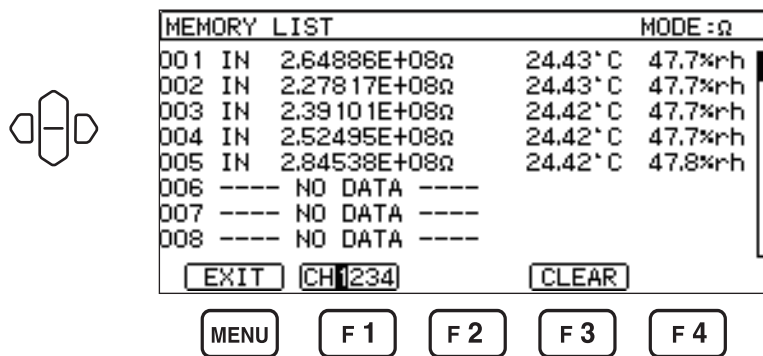

You can scroll the list by pressing the up or down cursor key.

You can scroll the list one screen at a time by pressing the right or left cursor key.

Press the **MODE** key to switch the measurement mode.

The channel switches to another in the order from CH1 through CH4 every time the **F1** key **[CH1234]** is pressed.

2 Press the **F3** key [CLEAR].

The confirmation dialog box is displayed.

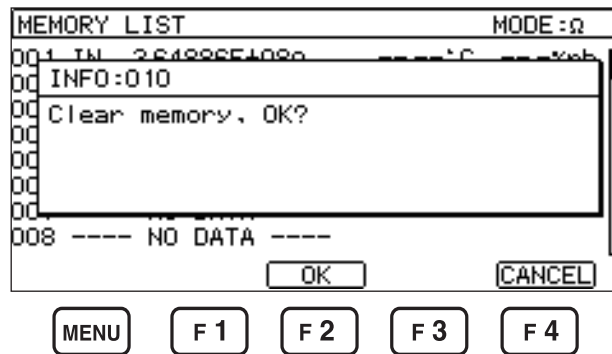

To cancel the deletion of memory data, press the **F4** key [CANCEL] or the **ESC** key.

3 Press the **F2** key [OK].

The memory data is deleted.

8.4 Setting D/A Output

Select a channel used for D/A output.

Procedure to display the settings screen: (Measurement screen) **MENU** key >  [SYS] tab

Press one of the keys among from the **F1** key [CH1] through the **F4** key [CH4] to select the channel.

CH1 to CH4 (default setting: CH1)

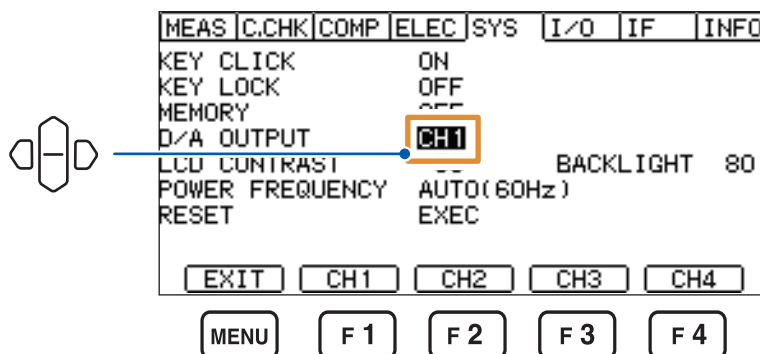

8.5 Adjusting Screen Contrast

The visibility of the screen may not be clear at some ambient temperatures. The visibility of the screen can be adjusted by adjusting the screen contrast.

Procedure to display the settings screen: (Measurement screen) **MENU** key >  **[SYS]** tab

0% to 100%, in increments of 5% (default setting: 50%)

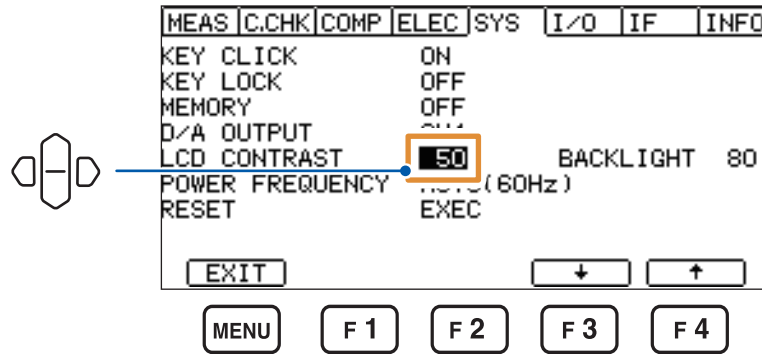

Press the **F3** key [**↓**] or **F4** key [**↑**] to change the value.

8.6 Adjusting Backlight Brightness

The brightness of the backlight can be adjusted for the illumination of the installation location.

Procedure to display the settings screen: (Measurement screen) **MENU** key >  **[SYS]** tab

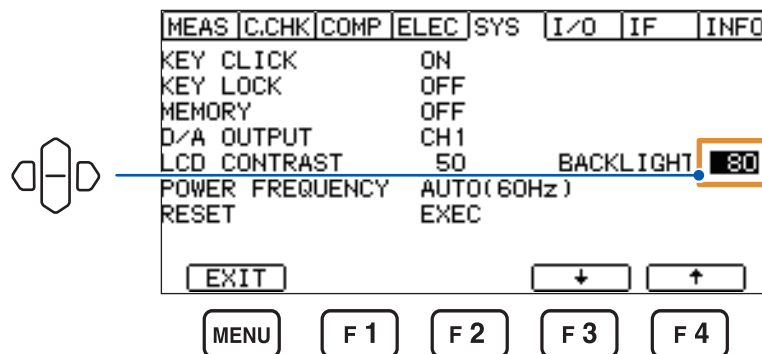

0% to 100%, in increments of 5% (default setting: 80%)



Press the **F3** key [**↓**] or **F4** key [**↑**] to change the value.

8.7 Changing Power Frequency Setting (Power Frequency Setting Function)

You can change the setting for the power frequency. This enables stable measurement without being affected by the power frequency.

Procedure to display the settings screen: **MENU** key >   **[SYS]** tab

- [AUTO]** Automatically detects either 50 Hz or 60 Hz (default setting).
- [50Hz]** 50 Hz
- [60Hz]** 60 Hz

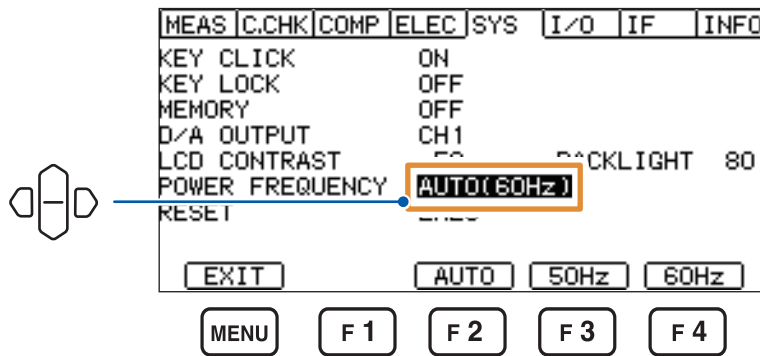

8.8 Initializing Settings (Reset)

The reset function has 2 methods.

For details of items that are to be reset, see “Default setting list” (p. 87).

Procedure to display the settings screen: (Measurement screen) **MENU** key >  **[SYS]** tab

1 Select the reset method.

[NORMAL] Resets the settings to the factory default excluding the panel data (The communication settings are not reset).

[SYSTEM] Resets all the settings to the factory default including the panel data (The communication settings are not reset).

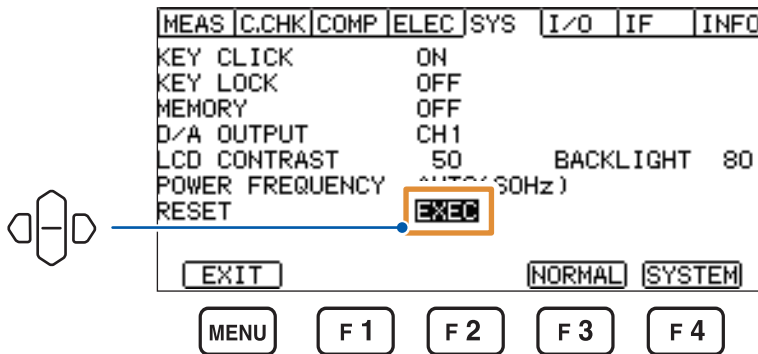

The confirmation dialog box is displayed.

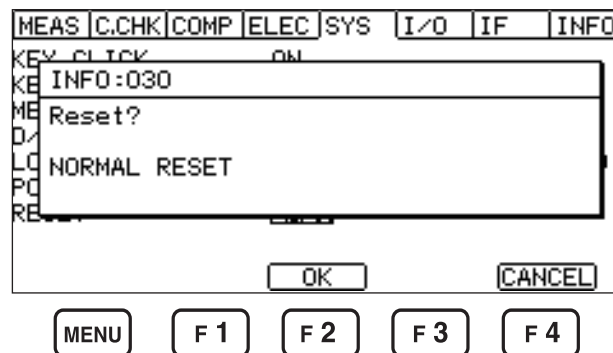

To cancel the reset operation, press the **F4** key **[CANCEL]** or the **ESC** key.

2 Press the **F2** key **[OK]**.

The reset operation is executed.

To reset all of the settings including those of the panel data and the communications to the factory default, turn off the instrument once, and then turn it on while holding down both the **MENU** key and the **LOAD/SAVE** key.

Default setting list

	Setting		Screen display	Default setting	Reference
Measurement screen	Voltage value for resistance calculation		EXT.V	0.1 V	p. 35
	Measurement speed		SPEED	SLOW2	p. 36
	Range		RANGE	AUTO	p. 37
	Delay function		DELAY	0.0 ms	p. 43
	Average function		AVG	OFF	p. 44
	Measured value display mode		–	Resistance value display	p. 33
MEAS	Measured value display	Mode	MEAS FORMAT	EXP (exponent display)	p. 34
		Displayed digit	DIGIT	6 digits	p. 34
	Updating Drawing During Measurement		DISP UPDATE	ON	p. 58
	Trigger mode		TRIGGER	INTERNAL (Internal trigger)	p. 46
	Self-calibration	Setting	SELF CALIBRATION	ON	p. 47
Setting time		–	600 s		
C.CHK	Contact check setting	Frequency	FREQ	300 kHz	p. 49
		Work capacitance	WORK.C	NORMAL	
		Cable length	CABLE	1.0 m	
		Delay time	DELAY	0 ms	
	Contact check	Setting	CONTACT CHECK	OFF	p. 53
		Judgment reference value	LIMIT	0.00 pF	
COMP	Comparator function (for each measurement mode)	Upper limit value	UPPER LIMIT	OFF	p. 69
		Lower limit value	LOWER LIMIT	OFF	
	Judgment sound (Hi, IN, Lo)	Judgment sound	COMP BEEP	OFF	p. 71
		Number of rings for judgment	–	1	
ELEC	Diameter of the main electrode		D1	50.0 mm	p. 55
	Internal diameter of the counter electrode		D2	70.0 mm	
	Thickness of sample		t	0.1 mm	
	Electrode constant		K	500.00	
SYS	Key operation sound		KEY CLICK	ON	p. 79
	Key lock		KEY LOCK	OFF	p. 80
	Memory function		MEMORY	OFF	p. 81
	D/A output function		D/A OUTPUT	CH1	p. 83
	LCD contrast		LCD CONTRAST	50%	p. 84
	LCD brightness		BACKLIGHT	80%	p. 84
	Power frequency		POWER FREQUENCY	AUTO (automatically detects either 50 Hz or 60 Hz)	p. 85
I/O	Trigger logic setting		TRIG EDGE	ON	p. 104
	Trigger filter	Function	TRIG FILTER	OFF	p. 105
		Time	–	1 ms	
	GO-signal outputting logic level		C.CHK GO	NOMAL	p. 106
	EOM output timing	Mode	EOM MODE	HOLD	p. 107
		Time	–	1 ms	
Output signal setting		–	NPN (switch on rear)	p. 90	

	Setting	Screen display	Default setting	Reference
IF	Communication Interface	INTERFACE	RS-232C	p. 109
	RS-232C communication speed	SPEED	9600 bps	p. 113
	GP-IB address	ADDRESS	1	p. 114
	GP-IB delimiter	DELIMITER	LF	
	USB mode	USB MODE	COMM	p. 110
	Data output function	DATA OUT	OFF	p. 116
	Communication monitor function	CMD MONITOR	OFF	p. 117

8.9 Checking Instrument Information

You can check the following information:

- Model name of the product
- Version number of the main CPU
- Version number of the sub CPU
- Version number of the CPLD
- Serial number

Procedure to display the settings screen: (Measurement screen) **MENU** key >  **[INFO]** tab

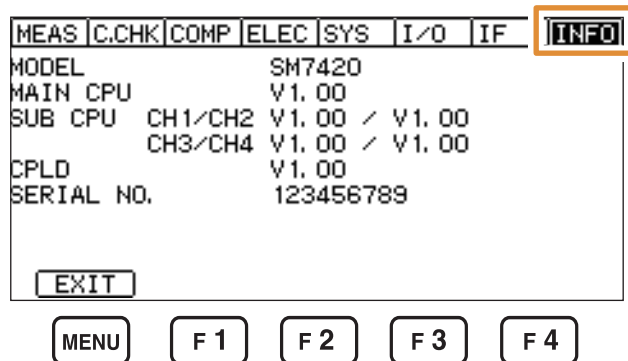

9

External Control (EXT I/O)

Be sure to read “Before controlling the instrument externally” (p. 12) beforehand.

Connecting the instrument to an external device such as a PLC (programmable logic controller) via the EXT I/O terminal on the rear of the instrument enables you to control the instrument in the following ways:

- Output signals from the instrument to the external device (for example, end of measurement and judgment result signals, etc.).
- Input signals from the external device to the instrument (for example, measurement starting signal, etc.).

All of the signals are isolated from the measurement circuit and the ground. (The ISO-COM terminals are shared by the input and the output.)

The input circuit can be switched so as to correspond to the current sink output (NPN) or the current source output (PNP).

To use the instrument properly, confirm the input/output ratings and the internal circuit configuration, and understand the safety precautions before connecting cables to a control system.

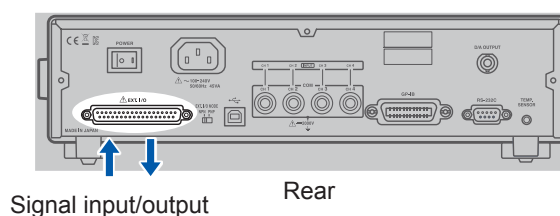

Check the input/output specifications of the external device.



Set the NPN/PNP switch of the instrument (p. 90).



Connect the EXT I/O terminal of the instrument to the external device (p. 90).



Test I/O (signal input and output test) (p. 103).



Set the instrument (p. 104).

9.1 Switching Current Sink (NPN) / Current Source (PNP)

Be sure to read “Before controlling the instrument externally” (p. 12) beforehand.

Use the EXT I/O MODE selector switch to change the type of the PLC that can be supported. By factory default, the external I/O setting is set to NPN.

	NPN/PNP switch setting	
	NPN	PNP
Input circuit of the instrument	Supports sink output	Supports source output
Output circuit of the instrument	Non-polar	Non-polar
ISO_5V output	+5 V output	-5 V output

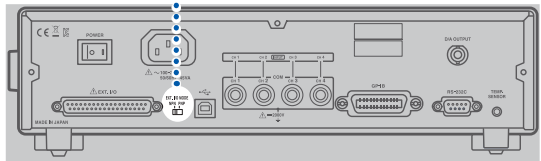
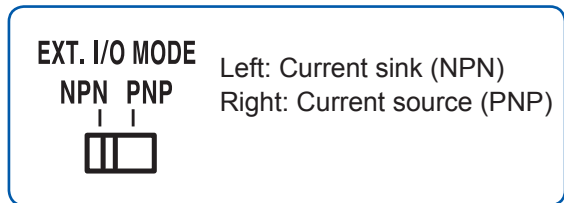

Rear

9.2 External Input/Output Terminals and Signals

Instrument-side connector and mating connectors

Be sure to read “Before controlling the instrument externally” (p. 12) beforehand.

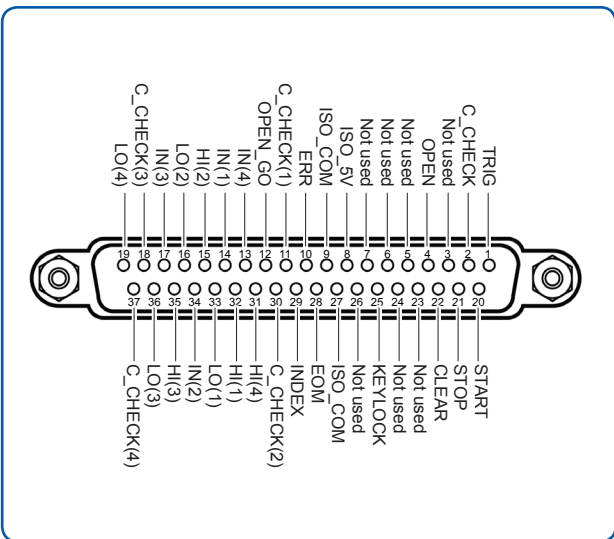

Connector

- 37-pin D-sub socket contact
- #4-40 inch screws

Mating connectors

- DC-37P-U/LR (solder type)
 - DCSP-JB37PR (crimp type)
- Manufactured by Japan Aviation Electronics Industry, Ltd.
Or other equivalent parts

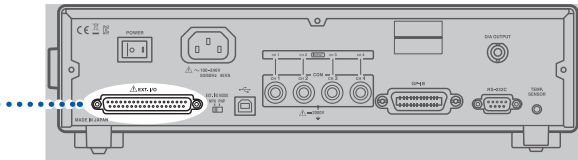

Rear

Instrument-side connector pin assignment

IMPORTANT

The connector shell is connected (allows conduction) to the metallic enclosure and the protective earth pin of the power inlet. Note that it is not isolated from the ground.

Pin No.	Signal name	I/O	Function	Operation mode
1	TRIG	IN	Starts a measurement.	Edge
2	C_CHECK	IN	Executes a contact check.	Edge
3	Not used	IN	(NC)	–
4	OPEN	IN	Executes an open correction.	Edge
5	Not used	IN	(NC)	–
6	Not used	IN	(NC)	–
7	Not used	IN	(NC)	–
8	ISO_5V	–	+5 V (–5 V) output of isolated power supply	–
9	ISO_COM	–	Common terminal of isolated power supply	–
10	ERR	OUT	Measurement error	Level
11	C_CHECK_GO(1)	OUT	Contact check result for CH1	Level
12	OPEN_GO	OUT	Open correction result	Level
13	IN (4)	OUT	Comparator judgment of IN for CH4	Level
14	IN (1)	OUT	Comparator judgment of IN for CH1	Level
15	HI (2)	OUT	Comparator judgment of Hi for CH2	Level
16	LO (2)	OUT	Comparator judgment of Lo for CH2	Level
17	IN (3)	OUT	Comparator judgment of IN for CH3	Level
18	C_CHECK_GO (3)	OUT	Contact check result for CH3	Level
19	LO (4)	OUT	Comparator judgment of Lo for CH4	Level
20	START	IN	Starts measurement.	Edge
21	STOP	IN	Stops measurement.	Edge
22	CREAR	IN	Clears measured value and judgment result.	Edge
23	Not used	IN	(NC)	–
24	Not used	IN	(NC)	–
25	KEYLOCK	IN	Activates the key lock.	Level
26	Not used	IN	(NC)	–
27	ISO_COM	–	Common terminal of isolated power supply	–
28	EOM	OUT	End of measurement	Level
29	INDEX	OUT	Measurement reference	Level
30	C_CHECK_GO (2)	OUT	Contact check result for CH2	Level
31	HI (4)	OUT	Comparator judgment of Hi for CH4	Level
32	HI (1)	OUT	Comparator judgment of Hi for CH1	Level

Pin No.	Signal name	I/O	Function	Operation mode
33	LO (1)	OUT	Comparator judgment of Lo for CH1	Level
34	IN (2)	OUT	Comparator judgment of IN for CH2	Level
35	HI (3)	OUT	Comparator judgment of Hi for CH3	Level
36	LO (3)	OUT	Comparator judgment of Lo for CH3	Level
37	C_CHECK_GO (4)	OUT	Contact check result for CH4	Level

Functions of each of the signals

IMPORTANT

- The EOM and INDEX signals are turned on when the instrument starts up.
- To avoid misjudgment, determine judgments by checking all of the HI, IN and LO signals.

Input signal

OPEN	Executes an open correction.	Setting the input to the on state executes an open correction.
START	Starts measurement.	Setting the input to the on state lets the instrument operate in the following ways: With the internal trigger setting, starts a measurement. With the external trigger setting, sets the instrument waiting for a TRIG signal.
TRIG	Starts a measurement.	Setting the input to the on state starts a measurement.
C_CHECK	Executes a contact check.	Setting the input to the on state executes a contact check.
STOP	Stops a measurement.	Setting the input to the on state lets the instrument operate in the following ways: With the internal trigger setting, stops a measurement. With the external trigger setting, terminates the measurement, not updating the measured value.
CLEAR	Clears a measured value and judgment result.	When a measurement is not performed, inputting the On signal clears a measured value and judgment result. After clearing them, the instrument will return a response indicating that no measurement is performed in response to a measured-value query of the communication commands.
KEYLOCK	Activates the key lock.	Setting the input to the on state activates the key lock function.

Output signal

EOM	End of measurement	Outputs the On signal when the measurement and the judgment are completed.
INDEX	Measurement reference	Outputs the On signal when the measurement circuit finishes the A/D acquisition.
ERR	Measurement error	Outputs the On signal if a measurement error occurs. Outputs the On signal when the fixture-capacitance open correction value exceeds 99.999 pF.
C_CHECK_GO (1) through C_CHECK_GO (4)	Contact check result	Outputs the On signal when the contact check gives a pass judgment.
OPEN_GO	Open correction result	Outputs the On signal when the open correction gives a pass judgment.
HI (1) through HI (4)	Comparator judgment of Hi	Outputs the On signal when the comparator gives a Hi judgment.
IN (1) through IN (4)	Comparator judgment of IN	Outputs the On signal when the comparator gives an IN judgment.
LO (1) through LO (4)	Comparator judgment of Lo	Outputs the On signal when the comparator gives a Lo judgment.

9.3 Timing Chart

The levels of each signal represent whether the contacts are in the on or the off state. With the current source (PNP) setting, the voltage level of the corresponding output becomes high when an output state is on, and low when a state is off. If the output signal setting is set to the current sink (NPN), the voltage levels, high and low are inverted.

From when measurement starts to when judgment result is acquired

(1) Voltage output, measurement with external trigger setting

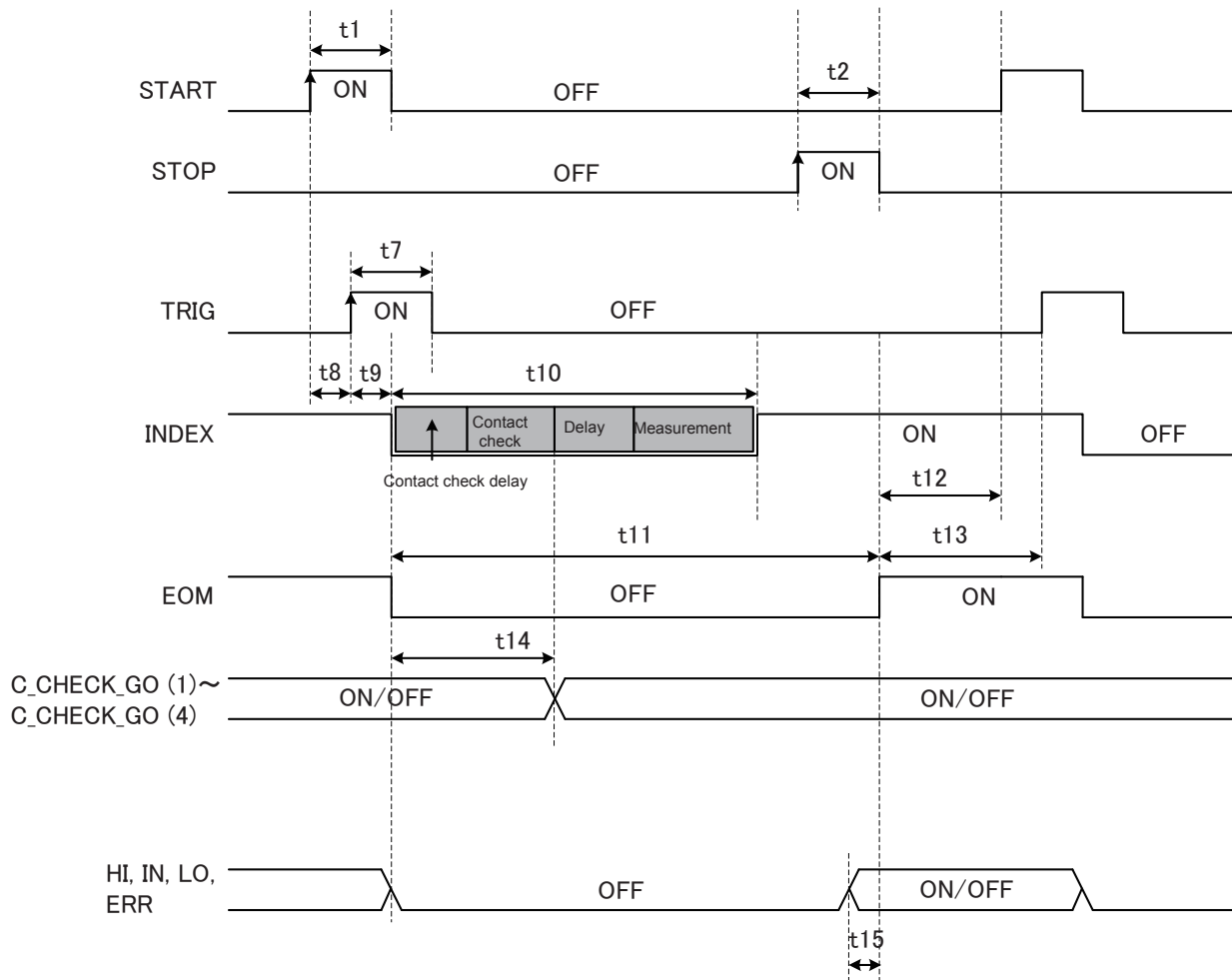

Item	Contents	Time
t1	START pulse width	200 μ s or more
t2	STOP pulse width	200 μ s or more
t7	TRIG pulse width	200 μ s or more
t8	TRIG acceptable time from START	0 μ s or more
t9	Delay time for INDEX and EOM	200 μ s or less
t10	INDEX time	([Contact check delay time] + [Contact checking time] + [Delay time] + [Measurement time]) or less
t11	EOM time	(INDEX + [Comparator measurement time] + 1.3 ms) or less
t12	START setup time	Display on: 40 ms or more Display off: 1 ms or more
t13	TRIG setup time	Display on: 40 ms or more Display off: 1 ms or more
t14	Judgment output time	3 ms or less
t15	Time required for the EOM signal to output after output of a judgment signal	70 μ s or more

(2) Measurement with internal trigger setting

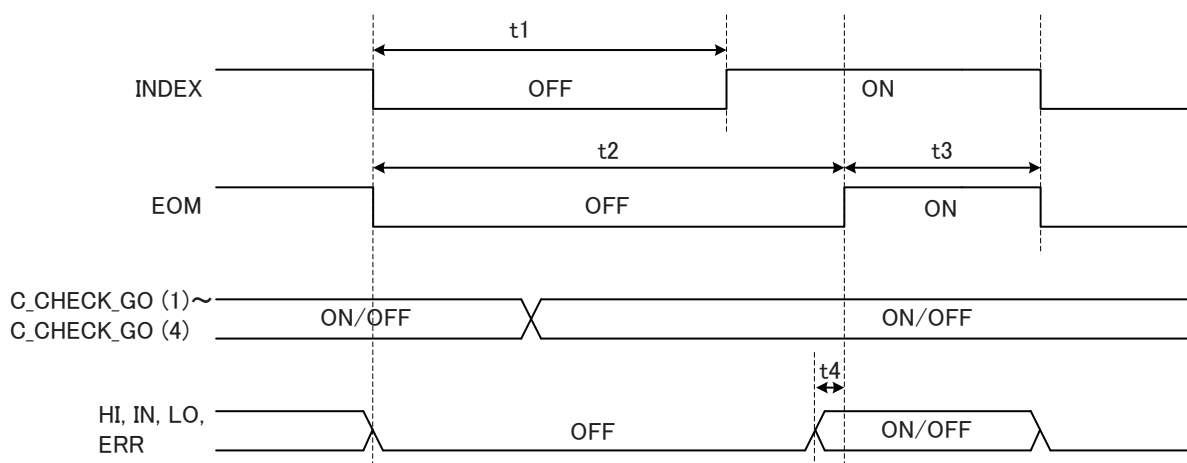

Item	Contents	Time
t1	INDEX time	([Contact checking time] + [Delay time] + [Measurement time]) or less
t2	EOM time	(INDEX + comparator measurement time + 1.3 ms) or less
t3	Internal TRIG setup time	40 ms \pm 5 ms
t4	Time required for the EOM signal to output after output of a judgment signal	70 μ s or more

(3) Contact check or open correction (independent execution)

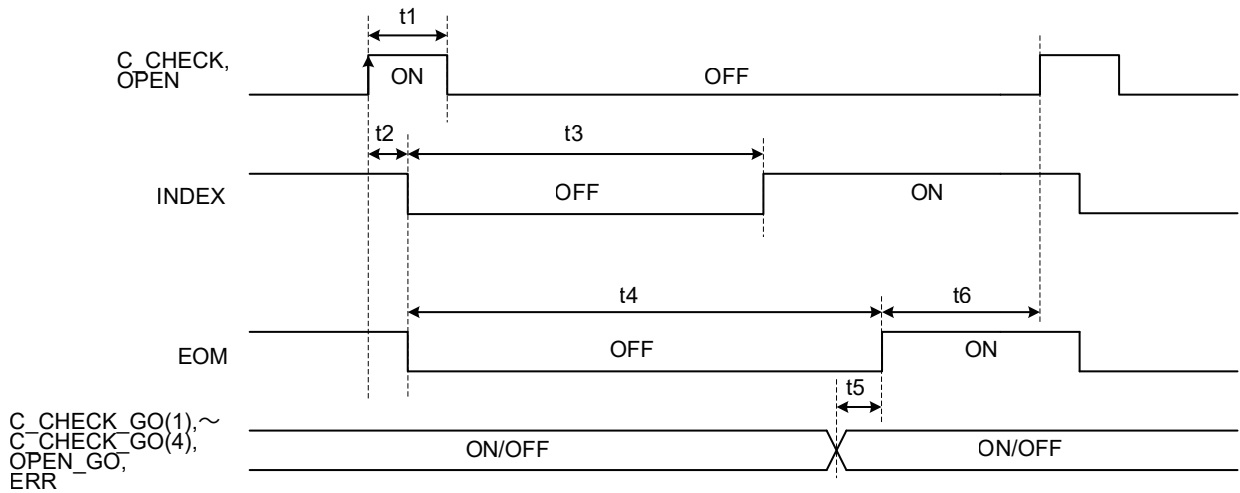

Item	Contents	Time
t1	C_CHECK, V_CHECK, OPEN pulse width	1 ms or more
t2	Delay time for INDEX and EOM	1.5 ms or less
t3	INDEX time	<ul style="list-style-type: none"> • Contact-checking time • Open correction time (200 ms) or less
t4	EOM time	(INDEX + 1 ms) or less
t5	Time required for the EOM signal to output after output of a judgment signal	100 μs or less
t6	C_CHECK, V_CHECK, OPEN setup time	Display ON: 40 ms or more Display OFF: 4 ms or more

(4) Clears measured value and judgment result.

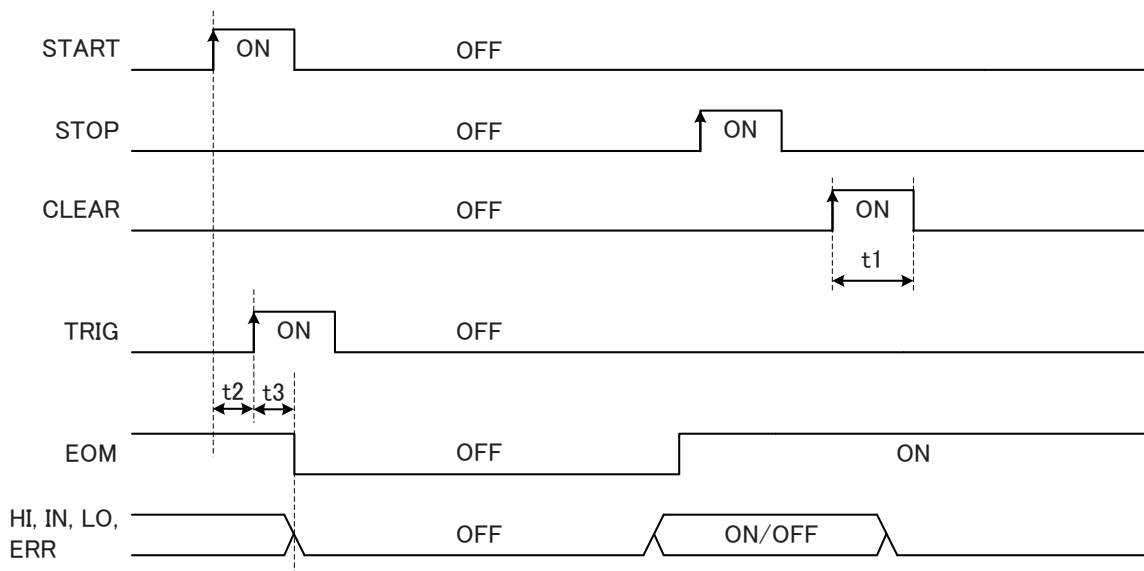

Item	Contents	Time
t1	CREAR pulse width	1 ms or more
t2	TRIG acceptable time from START	0 μs or more
t3	Delay time for EOM	200 μs or less

Output signal status on start-up

After turning on the instrument, when the screen changes from the start-up screen to the measurement screen, the EOM and INDEX signals change to ON.

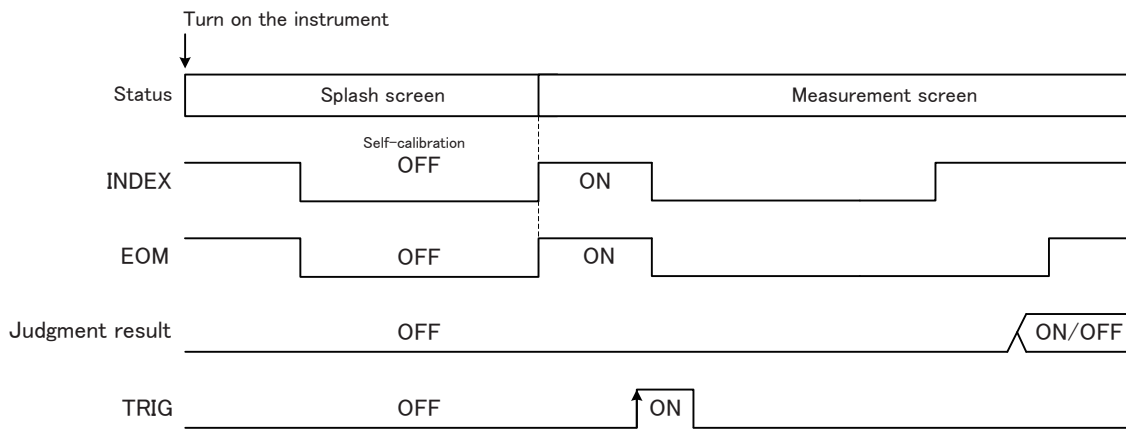

Judgment results: HI, IN, LO, ERR

The above chart indicates the operation when the trigger source is set to the EXT.

Flowchart for acquiring a judgment result or a measured value with the external trigger setting

The flowchart indicates the procedure with the external trigger setting from the start of the measurement to the acquisition of a judgment result or a measured value. The instrument outputs the EOM signal immediately after the judgment results (HI, IN, LO, PASS, FAIL, ERR) have been confirmed. If the response of the controller's input circuit is relatively slow, a waiting time is necessary from between the detection of the EOM signal switching to on and the acquisition of the judgment results.

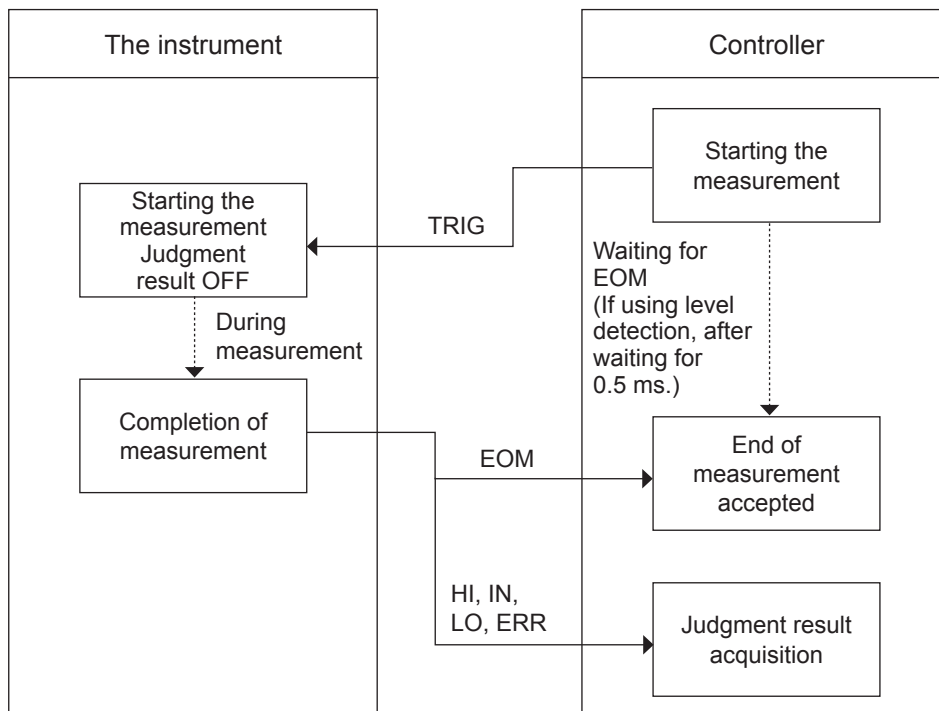

9.4 Internal Circuit Configuration

NPN setting

Do not connect any external power supply to Pin 8.
The instrument

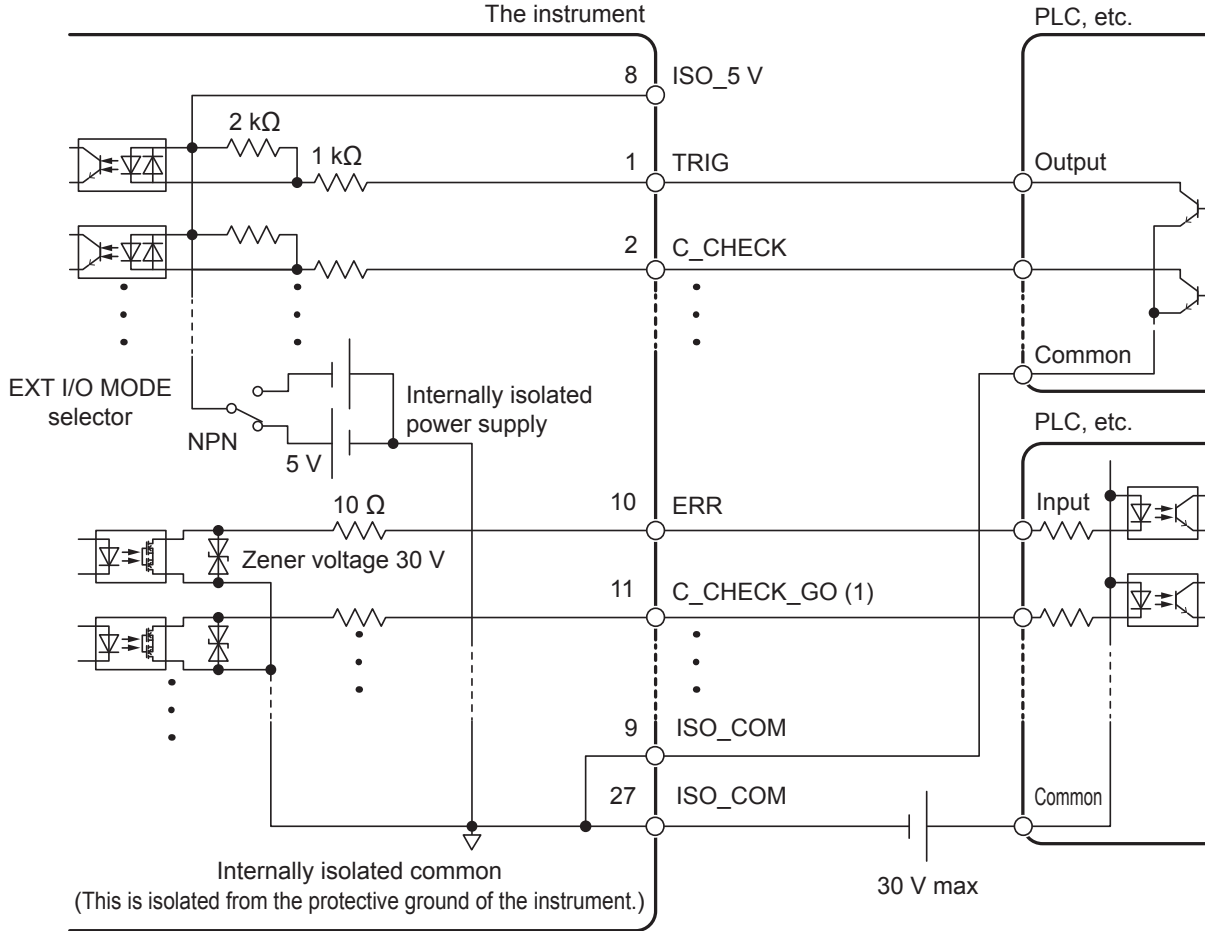

PNP setting

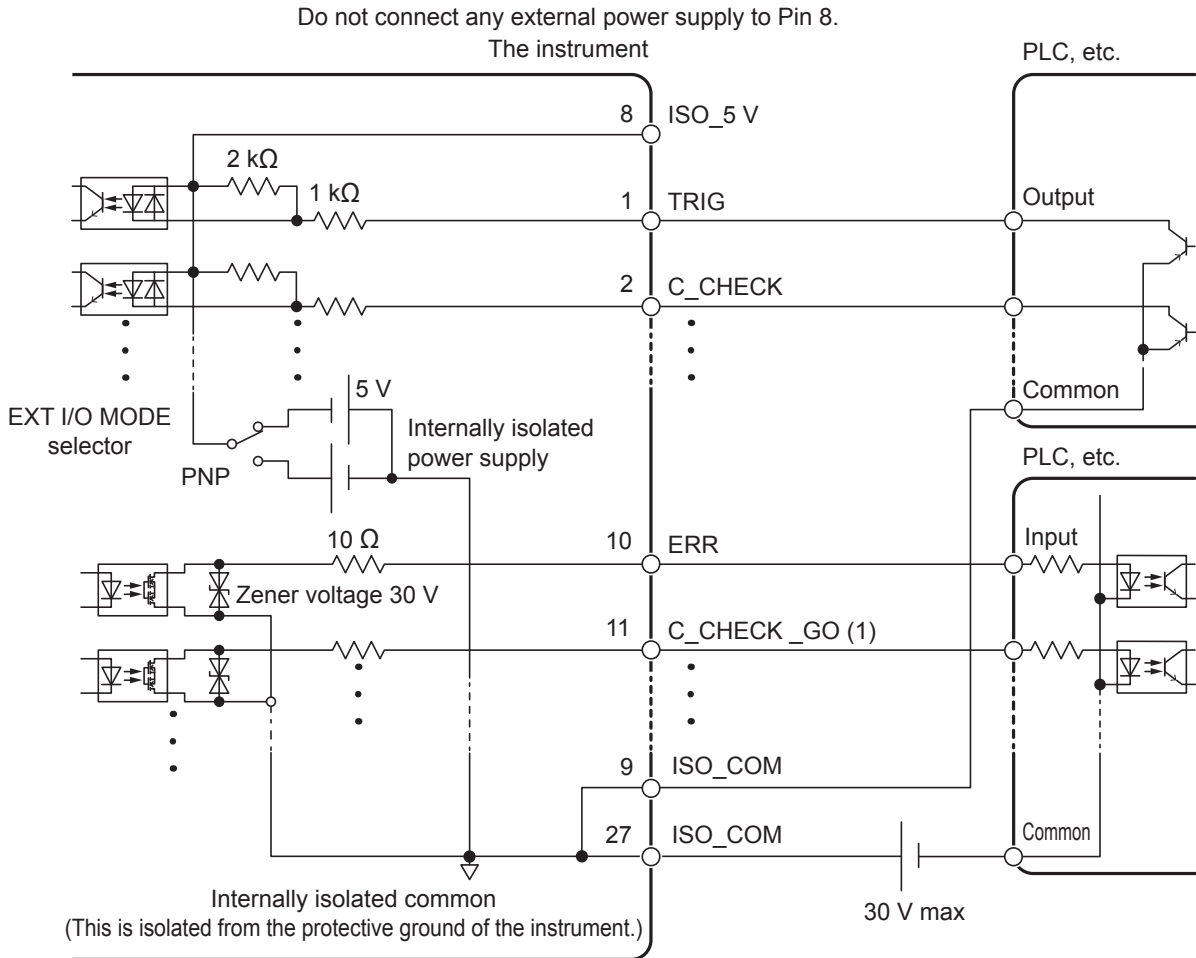

Share the ISO_COM for the common terminals of the input and the output signals.

Electrical Specifications

Input signal	Input type	Photo-coupler-isolated, non-voltage contact inputs (supporting current sink and current source outputs)
	Input on	Residual voltage 1 V or less (Input on current 4 mA [value for reference])
	Input off	Open-circuit (Breaking current: 100 μ A or less)
Output signal	Output type	Photo-coupler-isolated open drain output (non-polar)
	Maximum load voltage	30 V DC
	Maximum output current	50 mA/channel
	Residual voltage	1 V or less (Load current: 50 mA) / 0.5 V or less (Load current: 10 mA)
Internally isolated power supply	Output voltage	For sink output: +5.0 V \pm 10% For source output: -5.0 V \pm 10%
	Maximum output current	100 mA
	External power input	None
	Insulation	Floating from the protective ground potential and the measurement circuit
	Insulation rating	Voltage to ground 50 V DC, 30 V rms AC, 42.4 V peak AC or less

Examples of connection

Examples of input circuit connection

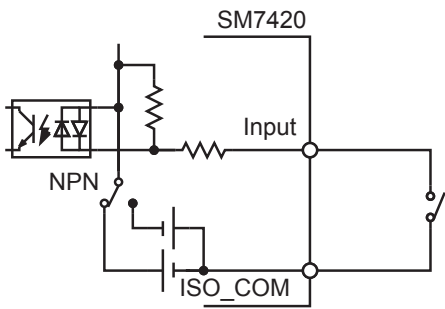

Connection to switch

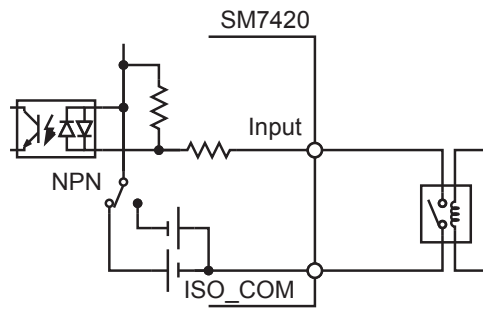

Connection to relay

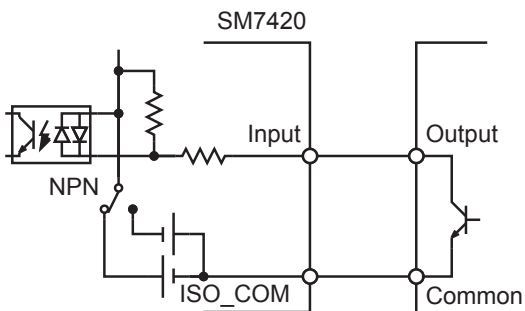

Connection to PLC output (NPN output)

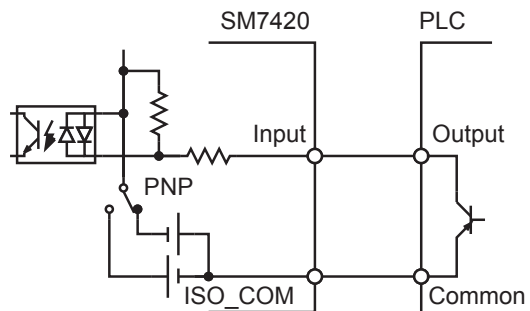

Connection to PLC output (PNP output)

Examples of output circuit connection

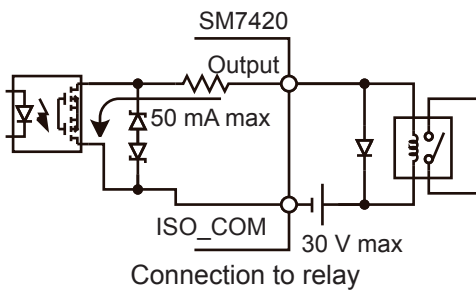

Connection to relay

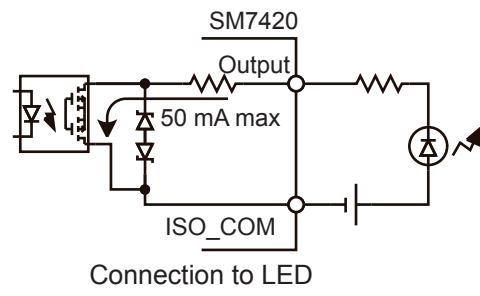

Connection to LED

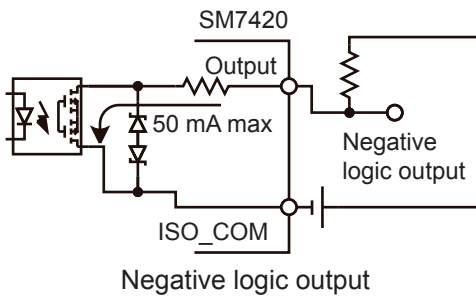

Negative logic output

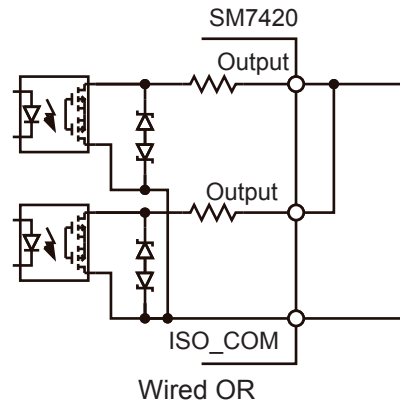

Wired OR

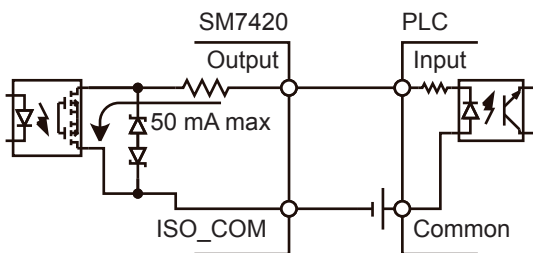

Connection to PLC input (positive common input)

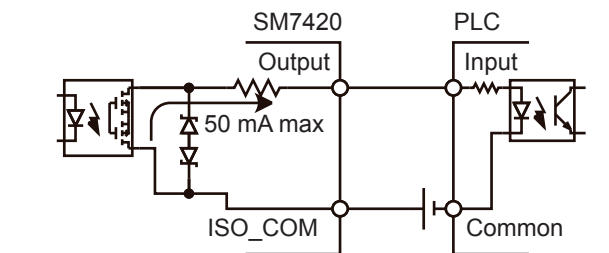

Connection to PLC input (negative common input)

9.5 Assembling Male Connector for EXT I/O (Accessory)

The male connector for the EXT I/O is supplied along with the instrument. Assemble the connector, referring to the figure below.

- Use a shielded wire for the cable that connects the EXT I/O connector to a device, such as PLC. Otherwise, the system may malfunction due to noise.
- Connect the shield of the wire to the ISO_COM terminal of the EXT I/O connector.

Required items:

- Screwdriver
- Cable (shielded wire recommended)
- Soldering iron
- Male connector for EXT I/O (accessory)
 - A: Hood (The upper and lower hoods have the same shape).....x2
 - B: Screw (Phillips slot combination) #4-40UNC (total length: 16.9 mm).....x2
 - C: Screw (Phillips slot combination) #4-40UNC (total length: 12.6 mm).....x2
 - D: Screw (slotted) #4-40UNC (total length: 15.0 mm).....x2
 - E: Nut #4-40UNC.....x2
 - F: Fastener (for cable).....x2
 - G: Fastener (case protection).....x2
 - H: Connector.....x1

- 1** Solder the cable to the connector (H).
- 2** Attach the fasteners (F) to the cable with the screws (C).
- 3** Set the fasteners (F) in the predetermined position on one of the hoods (A).
- 4** Insert the screws (D) into the fasteners (G).
- 5** Set the connector (H), fasteners (G), and screws (D) in the predetermined position on the hood (A) described in step 3.
- 6** Place the other hood (A) from above.
- 7** Secure the hoods (A) with each other with the screws (B) and the nuts (E).

Do not tighten the screws more than required, because doing so may damage the hoods.

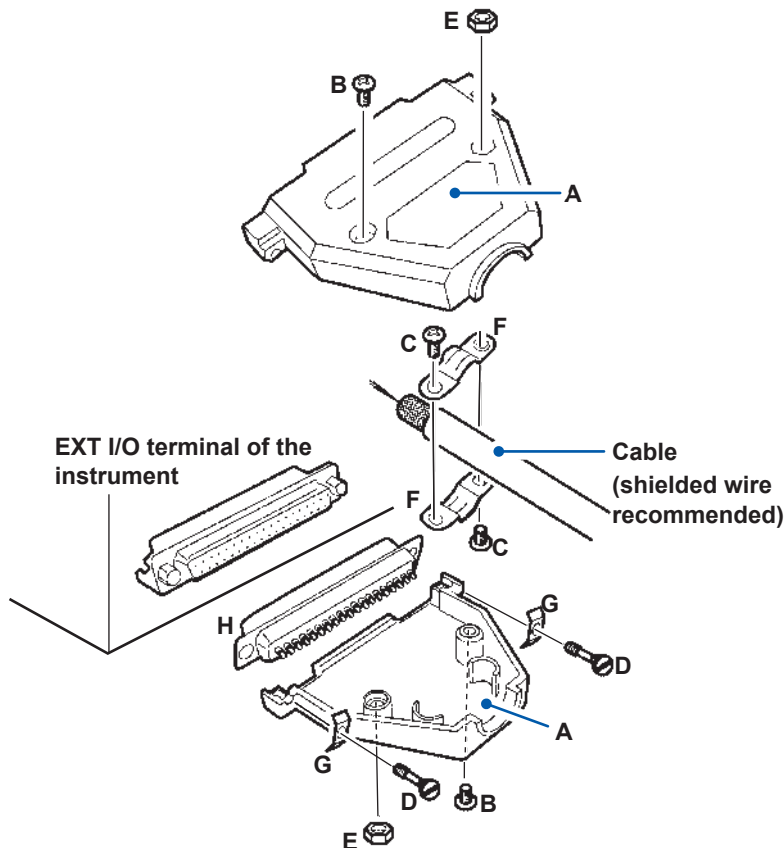

9.6 EXT I/O Terminal Input and Output Testing

The output signal can be switched on and off manually. In addition, the condition of the input signal can be monitored on the screen. (EXT I/O test function)

Procedure to display the settings screen: **MENU** key >  **[I/O]** tab

1 Press the **F2** key **[EXEC]**.

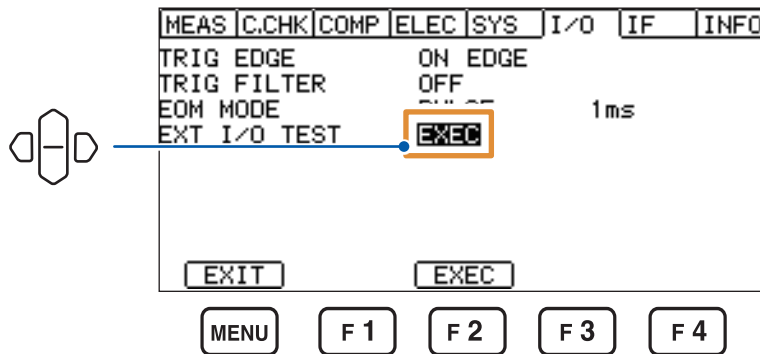

2	Output test	Input test
	<p>Select a signal, and press the F3 key [ON].</p> <p>The signal output starts.</p>	<p>Input a signal to the instrument.</p> <p>The boxed signal name for which a signal is input is highlighted in reverse video.</p>
	<p>Press the F4 key [OFF].</p> <p>The signal output stops.</p>	

For any of the tests, if the boxes are not highlighted in reverse video, then the instrument and the external device have not been connected with each other. Check the connection between them.

(Both commands and queries via communications could not be accepted during the I/O testing.)

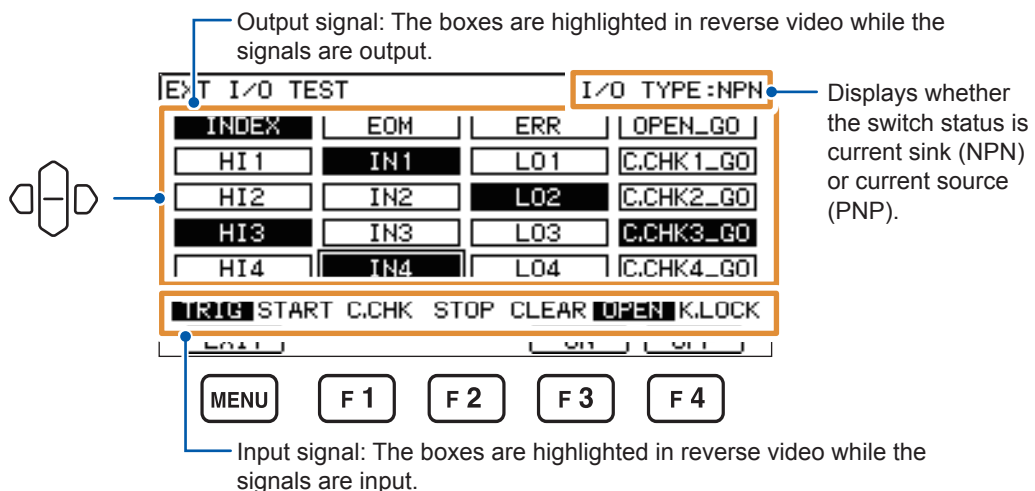

9.7 Settings for External Input and Output

The following items for the external input and output can be set.

Setting	Description	Reference
Trigger logic	An effective edge can be selected for the TRIG signal.	p. 104
Trigger filter	This setting can be used to accept the TRIG signal from the EXT I/O terminal only if the TRIG signal remains in the on state during the set response time.	p. 105
GO-signal outputting logic level	This setting can be used to specify the outputting logic level for the C_CHECK_GO signals, which are used with the contact check on.	p. 106
EOM signal output mode	This setting can be used to specify the output method for the EOM (end of measurement) signal.	p. 107

Trigger logic

An effective edge can be selected for the TRIG signal. The logic of the on and the off edges changes depending on the NPN/PNP setting.

- [ON EDGE]** PNP setting: Rising, NPN setting: Falling
- [OFF EDGE]** PNP setting: Falling, NPN setting: Rising

Procedure to display the settings screen: **MENU** key >  **[I/O]** tab

- [ON]** Measurement starts at an on edge (default setting)
- [OFF]** Measurement starts at an off edge

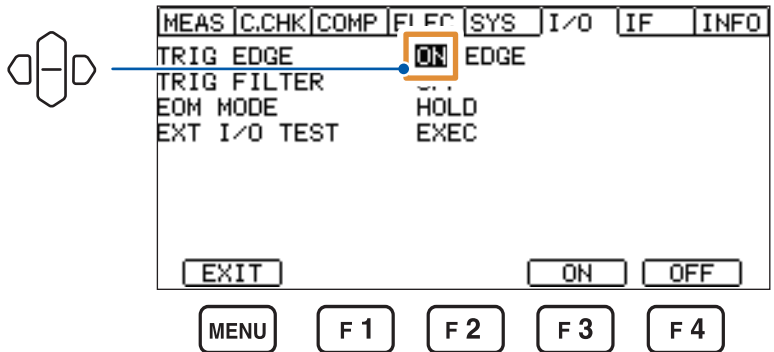

Trigger filter

This setting can be used to accept the TRIG signal from the EXT I/O terminal only if the TRIG signal remains in the on state during the set response time.

Procedure to display the settings screen: **MENU** key >  **[I/O]** tab

1 Select whether to activate the trigger filter or not.

[ON] Activate the trigger filter.

[OFF] Deactivate the trigger filter (default setting).

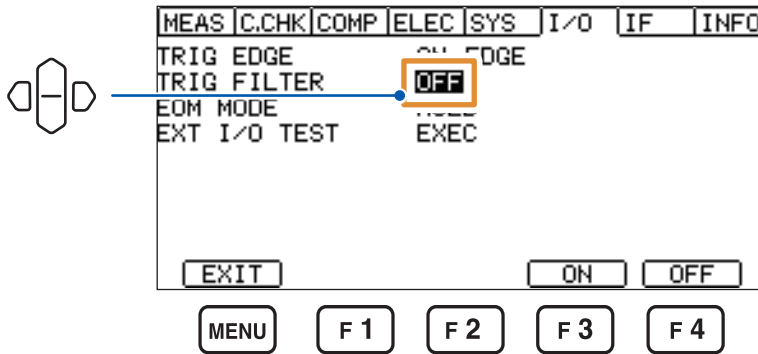

2 If **[ON]** is selected, set the response time (time during which the TRIG signal remains in the on state).

1 ms to 500 ms (default setting: 1 ms)

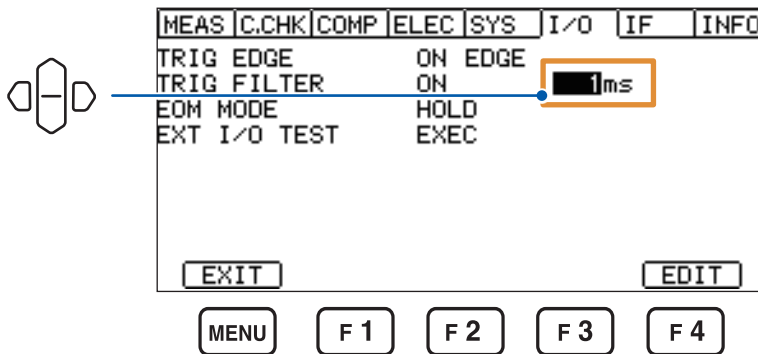

Pressing the **F4** key **[EDIT]** enables the numerical value to be changed.

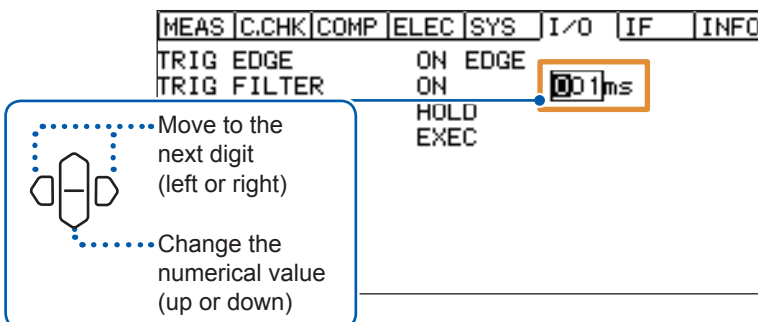

The numerical value can also be changed with the numeric keypad. See “Methods for changing numerical values” (p. 25).

GO-signal outputting logic level

This setting can specify the outputting logic level for the C_CHECK_GO and V_CHECK_GO signals, which are used with the contact check and voltage monitor on, respectively (No logic level of the OPEN_GO signal is inverted).

Procedure to display the settings screen: **MENU** key >  **[I/O]** tab

[NORMAL] When a pass judgment is given for the contact check: Outputs the On signal.
When a fail judgment is given for the contact check: Outputs the Off signal.
(default setting).

[INVERT] When a pass judgment is given for the contact check: Outputs the Off signal.
When a fail judgment is given for the contact check: Outputs the On signal.

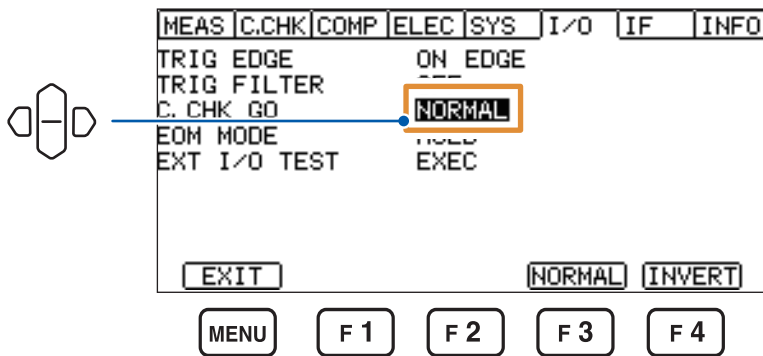

When the contact check is disabled, the instrument always gives fail judgments and thus outputs the Off signal.

EOM signal output mode

This setting can be used to specify the output method for the EOM (end of measurement) signal.

Procedure to display the settings screen: **MENU** key >  **[I/O]** tab

- 1 **Select whether to maintain the EOM signal in the on state or to switch it to the off state after the set time has elapsed.**

[HOLD] The EOM signal output remains in the on state until the next TRIG signal is input (default setting).

[PULSE] The EOM signal output remains in the off state after the set pulse width has elapsed.

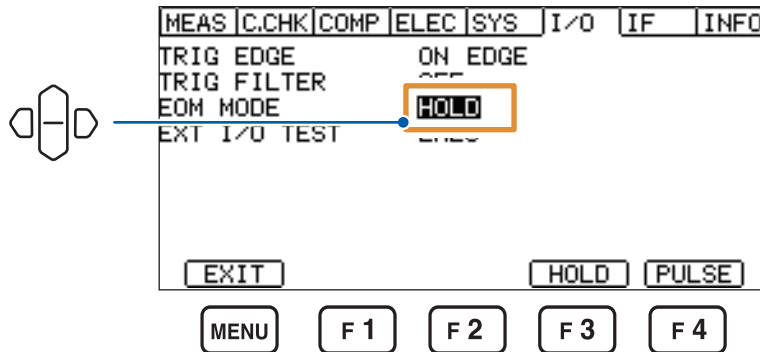

- 2 **If [PULSE] is selected, set the pulse width.**

1 ms to 100 ms (default setting: 1 ms)

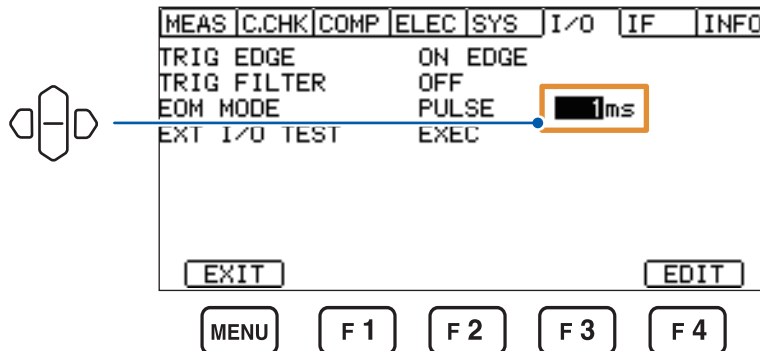

Pressing the **F4** key **[EDIT]** enables the numerical value to be changed.

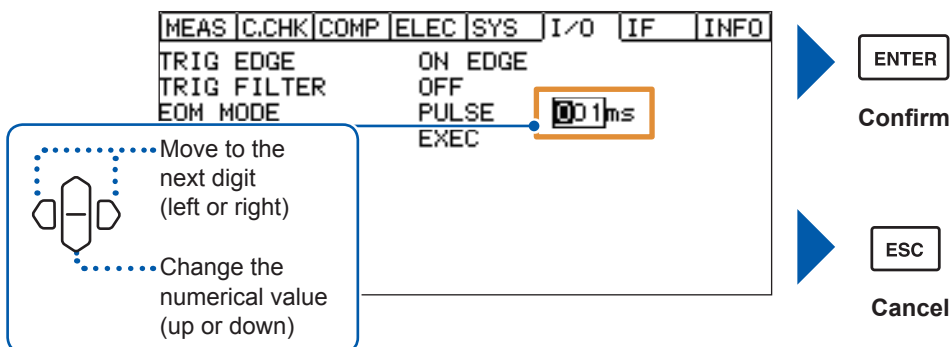

The numerical value can also be changed with the numeric keypad. See "Methods for changing numerical values" (p. 25).

10.1 Summary and Features of Interface

The instrument can be controlled and data can be acquired through communication commands by using the communication interface.

Multiple interfaces cannot be used simultaneously on the instrument.
The interface set on the [IF] screen is enabled.

MEAS	C.CHK	COMP	FILE	LEVELS	I/O	IF	INFO
INTERFACE			RS-232C				
SPEED			9600				
DATA OUT			OFF				
CMD MONITOR			OFF				
[EXIT]							

For details about the communication commands, refer to Communication Command Instruction Manual included in the accompanying CD.
They can also be downloaded from the Hioki website.

For the specifications, see “11.4 Interface Specifications” (p. 130).

10.2 USB Interface

Installing the USB driver

When the instrument is first connected to a computer, it is necessary to install the dedicated USB driver. If the driver has already been installed, skip the following procedure. The accompanying CD contains the USB driver. It can also be downloaded from the Hioki website.

Installation procedure

Install the USB driver before connecting the instrument to a computer with a USB cable. If the USB cable has been already connected to the computer, unplug it once.

- 1** Log into the computer with administrative privileges such as “administrator.”
- 2** Exit all applications that are running on the computer.
- 3** Open [X:\USB Driver] from the accompanying CD, and run [HiokiUsbCdcDriver.msi] (driver installer) (The drive name “X:” represents the CD-ROM drive).

It may take some time before the dialog box is displayed, depending on the system environment. Wait for the dialog box to be displayed.

- 4** After the installation is completed, connect the instrument and the computer with a USB cable.

The instrument is now recognized.

- If the Hardware Wizard window for new hardware is displayed, select [No, not this time] for the Windows Update connection prompt, and then select [Install the software automatically].
- If an instrument with a different serial number is connected, you may be notified that a new device has been detected. If this happens, install the USB driver, following the instructions on the screen.

Uninstallation procedure

Uninstall the driver if you no longer need it.

On the [Control Panel], click [Add or Remove Programs], and then delete [HOIKI USB CDC Driver].

Connecting the USB cable

Be sure to read “Before connecting the communication cable to the instrument” (p. 12) beforehand.

The USB cable shall have length of 3 m or less.

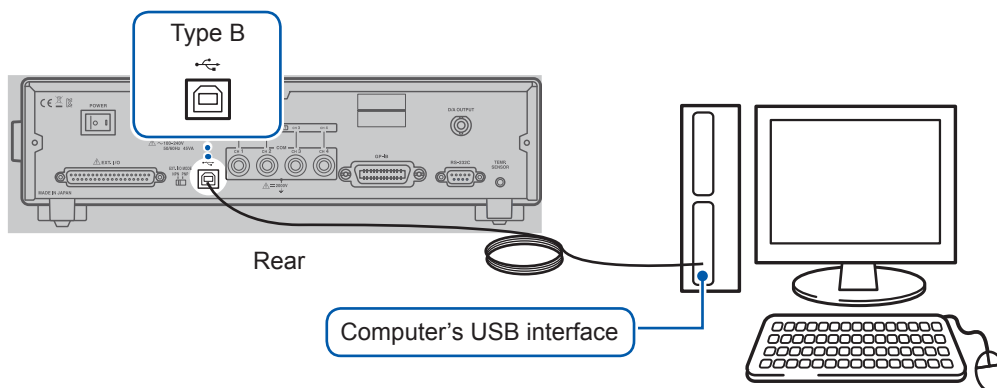

Setting the instrument

Procedure to display the settings screen: **MENU** key >  **[IF]** tab

1 Press the **F3** key **[USB]**.

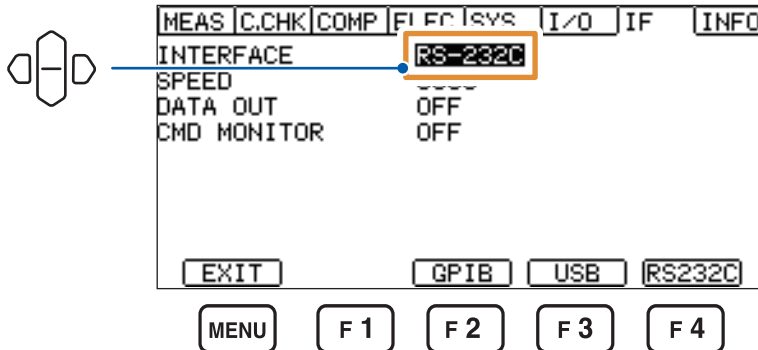

2 Set the USB mode.

[KEYBOARD]

Outputs measured values through the USB cable connected to the computer. Measured values are output to a text editor or spreadsheet in the same way as data is entered with a keyboard.

For the external trigger setting

The measurement value is output when the TRIG signal is input to the instrument or the **ENTER** key is pressed.

For the internal trigger setting

Latest measured values are automatically output every time the measurement is completed.

[COMM]

Controls the instrument with commands through the USB cable connected to the computer (default setting).

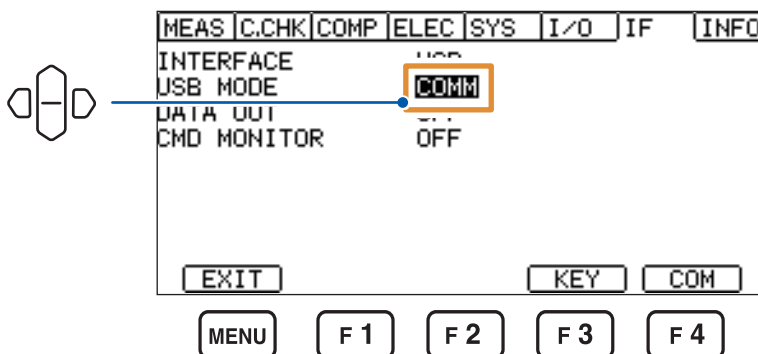

10.3 RS-232C Interface

Connecting the RS-232C cable

Be sure to read “Before connecting the communication cable to the instrument” (p. 12) beforehand.

Connect the RS-232C cable to the RS-232C connector. After connecting the cable to the instrument and another device, be sure to fasten the screws.

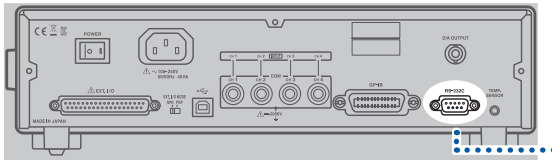

Rear

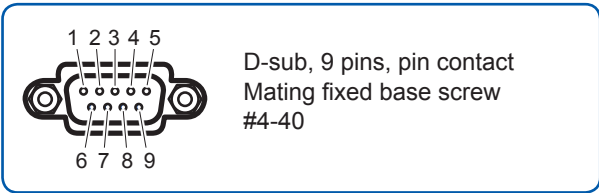

For connection with a data terminal equipment (DTE)

Prepare a cross cable that meets the specifications of the instrument and DTE connectors. The input/output connector conforms to DTE specifications. The instrument uses Pins 2, 3, and 5. The other pins are not used.

PIN No.	Signal name			Signal	Remarks
	Common	EIA	JIS		
1	DCD	CF	CD	Carrier detection	Unconnected
2	RxD	BB	RD	Receive data	
3	TxD	BA	SD	Transmit data	
4	DTR	CD	ER	Data terminal ready	Fixed at on level (+5 V to +9 V)
5	GND	AB	SG	Ground for signal	
6	DSR	CC	DR	Data set ready	Unconnected
7	RTS	CA	RS	Request to send	Fixed at on level (+5 V to +9 V)
8	CTS	CB	CS	Clear to send	Unconnected
9	RI	CE	CI	Calling indicator	Unconnected

When connecting instrument to computer

Use a cross cable with 9-pin female D-sub connectors installed at both ends.

Cross connection

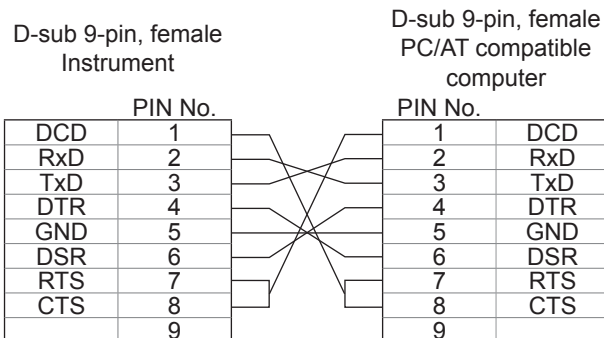

Recommended cable: Hioki Model 9637 RS-232C Cable (1.8 m)

Setting the instrument

Procedure to display the settings screen: **MENU** key >  **[IF]** tab

1 Press the **F4** key **[RS232C]**.

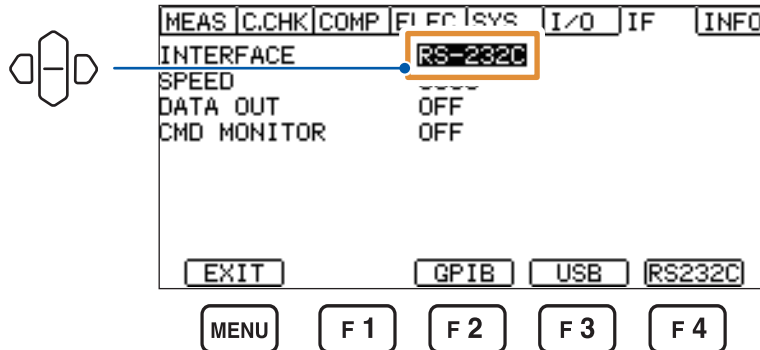

2 Set a transmission speed (baud rate).

4800 bps, 9600 bps, 19200 bps, 38400 bps, 115200 bps (default value: 9600 bps)

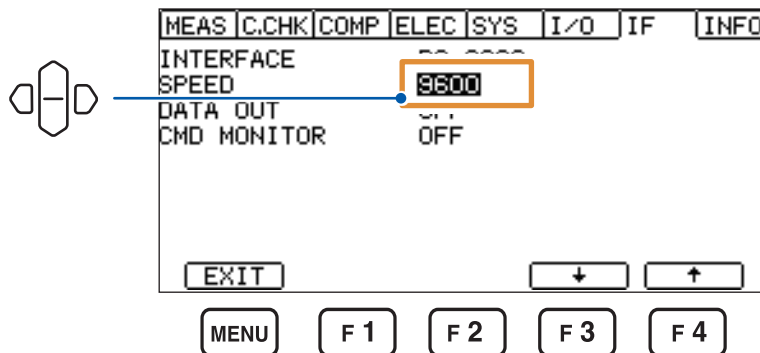

Press the **F3** key  or **F4** key  to select a value.

Setting the controller (Computer or PLC)

Change the controller settings to the following:

- Start-stop synchronization
- Transmission speed 4800 bps, 9600 bps, 19200 bps, 38400 bps, and 115200 bps (Adjust the speed to the instrument's setting.)
- Stop bit 1
- Data length 8
- Parity check None
- Flow control None

IMPORTANT

It may not be possible to use the fast transmission speed (baud rate) as errors caused by some computers is significant. In such cases, use a lower transmission speed.

10.4 GP-IB Interface

Connecting the GP-IB cable

Be sure to read “Before connecting the communication cable to the instrument” (p. 12) beforehand.

Connect the GP-IB cable to the GP-IB Connector. After connecting the cable to the instrument and another device, be sure to fasten the screws.

Recommended cable: Model 9151-02 GP-IB Connector Cable (2 m)

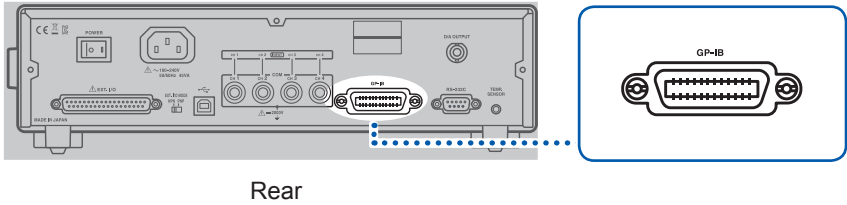

Setting the instrument

Procedure to display the settings screen: **MENU** key > [**IF**] tab

1 Press the **F2** key [**GPIB**].

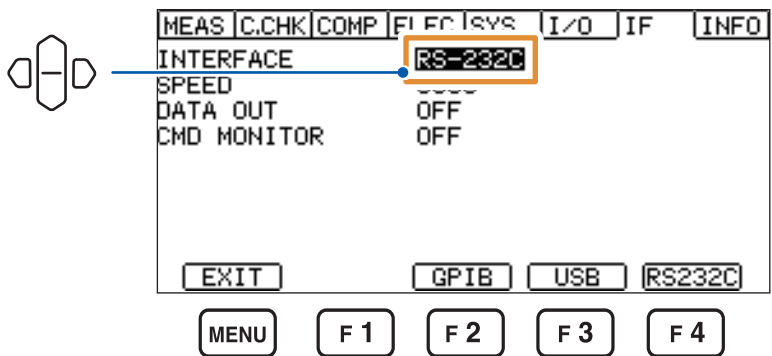

2 Set the device address.

0 to 30 (default setting: 1)

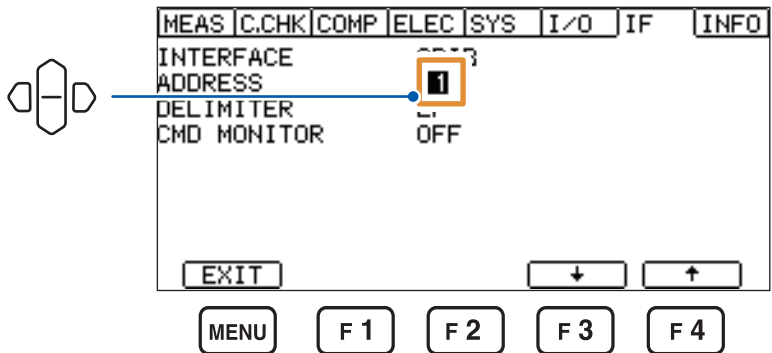

Press the **F3** key [**↓**] or **F4** key [**↑**] to select a value.

3 Set a delimiter.

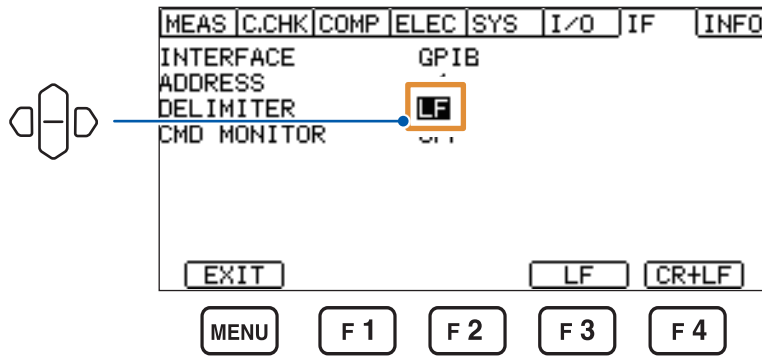

LF, CR+LF (default setting: LF)



10.5 Settings Common to Interfaces

Outputting measured values (data output function) (RS-232C and USB only)

Select whether to output the measured values automatically via each of the interfaces. Setting this function to **[ON]** disables the communication commands to control the instrument because the data output exclusively uses the interface.

Procedure to display the settings screen: **MENU** key >   **[IF]** tab

- [ON]** Outputs measured values.
- [OFF]** Does not output any measured values. (default setting)

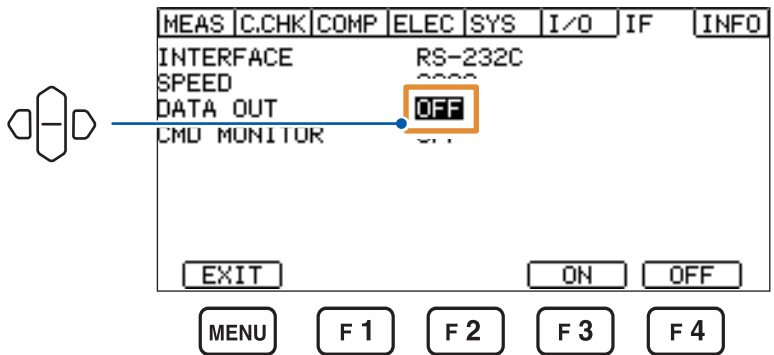

For the external trigger setting:

Measured values are output when the TRIG signal is input to the instrument or when the **ENTER (TRIG)** key is pressed.

For the internal trigger setting:

Latest measured values are automatically output every time the measurement is completed.

Displaying communication commands (communication monitor function)

The send and receive state of commands and queries can be checked on the screen.

Procedure to display the settings screen: **MENU** key >  **[IF]** tab

- [ON]** Displays commands.
- [OFF]** Does not display any commands. (default setting)

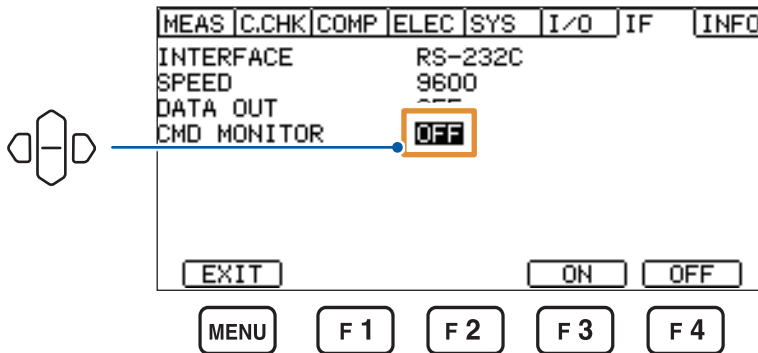

The communication monitor is displayed on the measurement screen when communication starts.

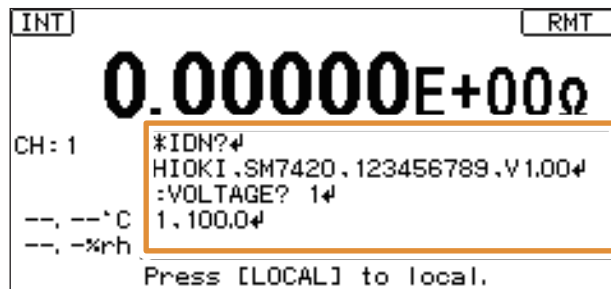

10.6 Control by Using Commands

For the description (communication message reference) of the communication commands and queries, refer to the Communication Command Instruction Manual, which is included in the accompanying CD.

Remote state

The instrument is placed in the remote state during the USB, RS-232C, or GP-IB communication, displaying **[RMT]** on the settings screen.

All the operation keys are disabled except the **LOCAL** key.

When the instrument changes to the remote state while the menu settings screen is displayed, the screen is automatically switched to the measurement screen.

```

INT                                RMT
CH 1  0.00000 E+00Ω  0.1V # :200uA
CH 2  0.00000 E+00Ω  0.1V # :200uA
CH 3  0.00000 E+00Ω  0.1V # :200uA
CH 4  0.00000 E+00Ω  0.1V # :200uA
--, --^C | SPEED: SLOW2    DELAY: 0ms
--, --%rh | AVG : AUTO
          | Press [LOCAL] to local.
  
```

Local state

The following operation deactivates the remote control and enables the key operation.

- Press the **LOCAL** key.
- Turn on the instrument again.
- Send the command **:SYSTEM:LOCAL** to the instrument via USB, RS-232C, or GP-IB.
- Send the command **GTL** from GP-IB to the instrument.

11.1 General Specifications

Operating environment	Indoors, Pollution Degree 2, altitude up to 2000 m (6562 ft.)	
Operating temperature and humidity	Temperature	0°C to 40°C (32°F to 104°F)
	Humidity	80% RH or less (no condensation)
Storage temperature and humidity	Temperature	-10°C to 50°C (14°F to 122°F)
	Humidity	80% RH or less (no condensation)
Standards	Safety	EN61010
	EMC	EN61326 Class A
Dielectric strength	4000 V AC (current sensitivity: 10 mA) Between bundle of power terminals and each of protective ground, interface, and measurement terminal	
Power	Commercial power	
	Rated supply voltage	100 V AC to 240 V AC (A supply voltage can fluctuate from the rated supply voltage within a band of plus or minus 10%.)
	Rated supply frequency	50 Hz / 60 Hz
	Anticipated transient overvoltage	2500 V
	Maximum rated power	45 VA
Interface	USB, RS-232C, GP-IB	
Dimensions	Approx. 330W × 80H × 450D mm (12.99"W × 3.15"H × 17.72"D) (excluding protrusions)	
Mass	Approx. 6.5 kg (229.3 oz.)	
Product warranty period	3 years	
	Connector, cable, etc.: Not covered by the warranty	
Accessories	See "Verifying Package Contents" (p. 3).	
Option	See "Options" (p. 4).	

11.2 Input/Output/Measurement Specifications

The underlined values are the default settings. The set values are retained even after the instrument is turned off.

Basic specifications

Number of channels	4		
Measurement method	Current measurement method		
Maximum rated voltage to earth	2000 V DC		
Ammeter input resistance	1 k Ω \pm 10%		
Input current	50 mA or less (1000 V or less), 1.8 mA or less (1000.1 V to 2000.0 V)		
Input/output terminals	Current input terminals	Four triaxial BNC connectors (Current input, internal guard, external shield)	
	COM terminals	Four banana terminals	
Liquid crystal display	LCD type	Monochrome graphic LCD 240 \times 110	
	Backlight	White LED	
		Brightness adjustment range:	0% to 100%, default: <u>80%</u> (in increments of 5%)
Contrast adjustment range:	0% to 100%, default: <u>50%</u> (in increments of 5%)		
Measured value display	When settings are changed or when a measurement starts		
Keys	Key types	MODE, RANGE \blacktriangle , RANGE \blacktriangledown , VOLT \blacktriangle , VOLT \blacktriangledown , COMP, LOAD/SAVE, SPEED, LOCAL, START, STOP, \uparrow , \downarrow , \leftarrow , \rightarrow , ESC, ENTER, MENU, F1, F2, F3, F4	
	Key lock function	Operation details	Disables the operation of keys. Communication commands can also enable the key operations.
		Setting	<u>OFF</u> , MENU, ALL
		MENU	Disables the operation of the following keys: COMP, LOAD/SAVE, and MENU
ALL	Disables the operation of all keys excluding the MENU key [UNLOCK] and the STOP key. Inputting the KEYLOCK signal disables all of the operation performed on the front panel.		
Key operation tone setting function	Setting	<u>ON</u> / OFF	

Accuracy specifications

Conditions of guaranteed accuracy	Guaranteed accuracy period	1 year																																																																										
	Guaranteed accuracy period from adjustments made by Hioki	1 year																																																																										
	Temperature and humidity for guaranteed accuracy	23°C±5°C (73°F±9°F), 80% RH or less																																																																										
	Warm-up time	At least 30 minutes																																																																										
	Power frequency range	50 Hz / 60 Hz ±2 Hz																																																																										
	Temperature coefficient	In temperature ranges of between 0°C and 18°C and between 28°C and 40°C, ±(measurement accuracy × 1/10)/°C is added.																																																																										
	Effect of radiated radio-frequency electromagnetic field	15% f.s. at 10 V/m																																																																										
Effect of conducted radio-frequency electromagnetic field	5% f.s. at 10 V																																																																											
Current measurement accuracy	<p>The accuracy listed in the following table is specified after calibration. Neglecting calibration reduces the accuracy, adding 50 dgt. to the following specifications.</p> <p>Guaranteed accuracy range: 5% to 100% of each range</p>																																																																											
<table border="1"> <thead> <tr> <th rowspan="2">Range</th> <th rowspan="2">Maximum display</th> <th rowspan="2">Resolution</th> <th colspan="4">Current measurement accuracy (±% rdg. ±dgt.)</th> </tr> <tr> <th>FAST/FAST2</th> <th>MED</th> <th>SLOW</th> <th>SLOW2</th> </tr> </thead> <tbody> <tr> <td>20 pA</td> <td>19.9999 pA</td> <td>0.1 fA</td> <td>–</td> <td>–</td> <td>2.0 + 450</td> <td>2.0 + 30</td> </tr> <tr> <td>200 pA</td> <td>199.999 pA</td> <td>1 fA</td> <td>–</td> <td>1.0 + 600</td> <td>1.0 + 45</td> <td>1.0 + 30</td> </tr> <tr> <td>2 nA</td> <td>1.99999 nA</td> <td>10 fA</td> <td>0.5 + 600</td> <td>0.5 + 40</td> <td>0.5 + 30</td> <td>0.5 + 20</td> </tr> <tr> <td>20 nA</td> <td>19.9999 nA</td> <td>100 fA</td> <td>0.5 + 30</td> <td>0.5 + 20</td> <td>0.5 + 15</td> <td>0.5 + 10</td> </tr> <tr> <td>200 nA</td> <td>199.999 nA</td> <td>1 pA</td> <td>0.5 + 30</td> <td>0.5 + 20</td> <td>0.5 + 15</td> <td>0.5 + 10</td> </tr> <tr> <td>2 μA</td> <td>1.99999 μA</td> <td>10 pA</td> <td>0.5 + 30</td> <td>0.5 + 20</td> <td>0.5 + 15</td> <td>0.5 + 10</td> </tr> <tr> <td>20 μA</td> <td>19.9999 μA</td> <td>100 pA</td> <td>0.5 + 30</td> <td>0.5 + 20</td> <td>0.5 + 15</td> <td>0.5 + 10</td> </tr> <tr> <td>200 μA</td> <td>199.999 μA</td> <td>1 nA</td> <td>0.5 + 30</td> <td>0.5 + 20</td> <td>0.5 + 15</td> <td>0.5 + 10</td> </tr> <tr> <td>2 mA</td> <td>1.99999 mA</td> <td>10 nA</td> <td>0.5 + 30</td> <td>–</td> <td>–</td> <td>–</td> </tr> </tbody> </table>			Range	Maximum display	Resolution	Current measurement accuracy (±% rdg. ±dgt.)				FAST/FAST2	MED	SLOW	SLOW2	20 pA	19.9999 pA	0.1 fA	–	–	2.0 + 450	2.0 + 30	200 pA	199.999 pA	1 fA	–	1.0 + 600	1.0 + 45	1.0 + 30	2 nA	1.99999 nA	10 fA	0.5 + 600	0.5 + 40	0.5 + 30	0.5 + 20	20 nA	19.9999 nA	100 fA	0.5 + 30	0.5 + 20	0.5 + 15	0.5 + 10	200 nA	199.999 nA	1 pA	0.5 + 30	0.5 + 20	0.5 + 15	0.5 + 10	2 μA	1.99999 μA	10 pA	0.5 + 30	0.5 + 20	0.5 + 15	0.5 + 10	20 μA	19.9999 μA	100 pA	0.5 + 30	0.5 + 20	0.5 + 15	0.5 + 10	200 μA	199.999 μA	1 nA	0.5 + 30	0.5 + 20	0.5 + 15	0.5 + 10	2 mA	1.99999 mA	10 nA	0.5 + 30	–	–	–
Range	Maximum display	Resolution				Current measurement accuracy (±% rdg. ±dgt.)																																																																						
			FAST/FAST2	MED	SLOW	SLOW2																																																																						
20 pA	19.9999 pA	0.1 fA	–	–	2.0 + 450	2.0 + 30																																																																						
200 pA	199.999 pA	1 fA	–	1.0 + 600	1.0 + 45	1.0 + 30																																																																						
2 nA	1.99999 nA	10 fA	0.5 + 600	0.5 + 40	0.5 + 30	0.5 + 20																																																																						
20 nA	19.9999 nA	100 fA	0.5 + 30	0.5 + 20	0.5 + 15	0.5 + 10																																																																						
200 nA	199.999 nA	1 pA	0.5 + 30	0.5 + 20	0.5 + 15	0.5 + 10																																																																						
2 μA	1.99999 μA	10 pA	0.5 + 30	0.5 + 20	0.5 + 15	0.5 + 10																																																																						
20 μA	19.9999 μA	100 pA	0.5 + 30	0.5 + 20	0.5 + 15	0.5 + 10																																																																						
200 μA	199.999 μA	1 nA	0.5 + 30	0.5 + 20	0.5 + 15	0.5 + 10																																																																						
2 mA	1.99999 mA	10 nA	0.5 + 30	–	–	–																																																																						
Resistance measurement accuracy	<p>The resistance measurement accuracy shall be considered as a reference and is not guaranteed.</p> <p>Reference: (Resistance measurement accuracy) = (Current measurement accuracy) + (External power supply generation accuracy)</p>																																																																											
Resistance value display range	50 Ω to 9.99999 × 10 ²⁰ Ω																																																																											

Measurement time

Settings of contact check function and comparator function	ON	OFF
Contact-checking time	2.3 ms	0.0 ms
Comparator measurement time	0.2 ms	0.0 ms

Setting of measurement speed	50 Hz	60 Hz	Internal integration time
FAST	4.1 ms	4.1 ms	2 ms
FAST2	13.7 ms	12.7 ms	0.5 PLC
MED	23.7 ms	20.7 ms	1 PLC
SLOW	109 ms	93 ms	4 PLC
SLOW2	320 ms	320 ms	13 PLC

- Using the external control (EXT I/O) extends the INDEX and the EOM times as follows:
INDEX time (Contact check delay time) + (Contact-checking time) + (Delay time) + (Measurement time)
EOM time INDEX + (Comparator measurement time) + 1.3 ms

• Self-calibration time: 5 s or less

Note: If the settings for the delay and the contact check delay vary among the channels, outputting the INDEX and the EOM signals delay using the longest delay time among the settings.

Measurement time examples (With the measurement speed set to FAST)

Contact check	Comparator measurement	Power frequency: 50 Hz		Power frequency: 60 Hz	
		INDEX	EOM	INDEX	EOM
OFF	OFF	4.1 ms	5.4 ms	4.1 ms	5.4 ms
OFF	ON	4.1 ms	5.6 ms	4.1 ms	5.6 ms
ON	OFF	6.4 ms	7.7 ms	6.4 ms	7.7 ms
ON	ON	6.4 ms	7.9 ms	6.4 ms	7.9 ms

Temperature measurement accuracy	Display range	-40.00°C to 80.00°C Displays [---.°C] with a temperature sensor not connected.
	Accuracy range	-40.00°C to 80.00°C
	Measurement accuracy	See “Specifications of Model Z2011 Humidity Sensor” (p. 123).
	Measurement period	2 ±0.2 s
Humidity measurement accuracy	Display range	0.0% RH to 90.0% RH Displays [---.%rh] with a humidity sensor not connected.
	Accuracy range	20.0% RH to 80.0% RH
	Measurement accuracy	See “Specifications of Model Z2011 Humidity Sensor” (p. 123).
	Measurement period	2 ±0.2 s
D/A output accuracy	Output accuracy	(Current measurement accuracy) ±0.2% f.s.
	Temperature coefficient	±0.02% f.s./°C
	Response time	(Measurement time) + 1 ms at a maximum

Specifications of Model Z2011 Humidity Sensor

Temperature measurement accuracy	±0.5°C (10°C to 60°C) Measuring temperature exceeding the range enclosed in parentheses above reduces this accuracy as follows: Add 0.015°C/°C (from -40°C inclusive to 10°C exclusive) Add 0.02°C/°C (from 60°C exclusive to 80°C inclusive)
---	--

Humidity measurement accuracy	±3% RH (20°C to 30°C, 20% RH to 90% RH) Measuring humidity exceeding the range enclosed in parentheses above reduces this accuracy as the following table.
--------------------------------------	---

Values marked with an asterisk (*) are out of the guaranteed accuracy range (values used as reference).

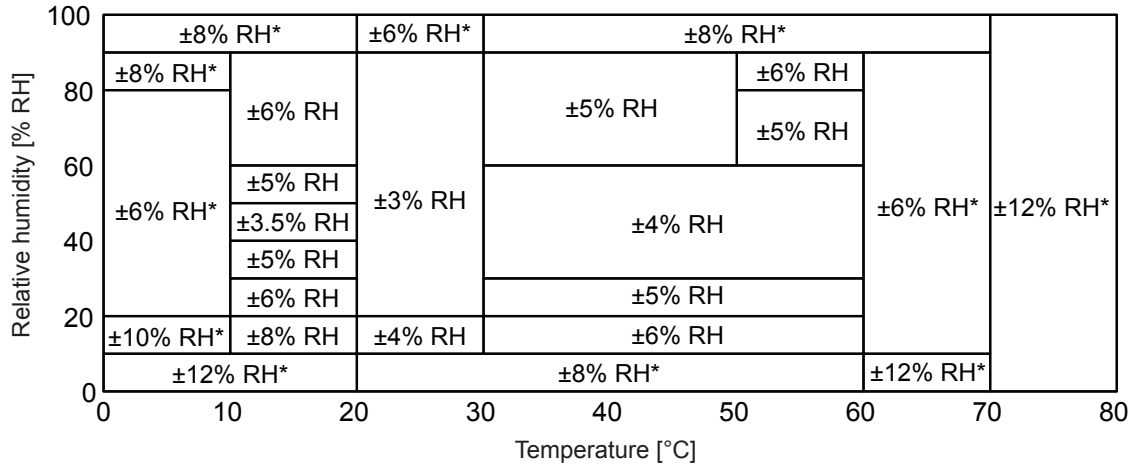

Hysteresis: ±1% RH

Response time	Approx. 300 s (Temperature: 90 percentile response time during a temperature change from 0°C to 60°C or from 60°C to 0°C [used as reference]) (Humidity: 90 percentile response time during a humidity change from 10% RH to 80% RH or from 80% RH to 10% RH [used as reference])
----------------------	---

11.3 Function specifications

The underlined values are the default settings. The set values are retained even after the instrument is turned off.

Measured value display mode	Displayed item	An item to be displayed can be selected between the following: resistance, current, surface resistivity, volume resistivity, and liquid volume resistivity.	
	Display format	<u>EXP</u> / UNIT	
		EXP Exponential notation	Displays values, expressed in exponential notation, to five decimal places. (Example: 1.00000E + 16 Ω).
		UNIT Decimal notation	Displays values, expressed in decimal notation, that have six significant figures. (Example: 10.0000 PΩ).
	Function to set the number of display digits	The number of display digits can be set in the range from 3 to <u>6</u> .	
	Resistance value	Calculated from the measured current value and the voltage setting value.	
	Resistivity	Calculated from the measured current value, the voltage setting value, and the electrode constant.	
Function of drawing update during measurement	Number of measured values to be displayed	Switching between the 1-channel display and the 4-channel display.	
	Channel setting	Common setting to all channels	
	Operation method	Changes the timing of updating the measured value display.	
Setting of voltage value for resistance calculation	Setting	<u>ON</u> / OFF	
		ON:	Updates the measured values every time a measurement is completed.
		OFF:	Updates the measured values only on STOP.
	Operation details	Selects the voltage value used for resistance calculation.	
Measurement speed	Voltage setting range	<u>0.1 V</u> to 5000.0 V	
	Channel setting	Separate setting for each channel	
	Operation details	Sets the sampling time.	
Range switching function	Setting	FAST / FAST2 / MED / SLOW / <u>SLOW2</u>	
	Channel setting	Common setting to all channels	
	Current measurement	<u>AUTO</u> / MANUAL	
Trigger mode	Resistance measurement	No setting (The current measurement set to AUTO will set the resistance measurement to AUTO.)	
	Channel setting	Separate setting for each channel If the [AUTO] setting is used, the INDEX time uses the longest among the settings of all the channels.	
	Operation details	Sets a trigger for starting measurement.	
Trigger mode	Setting	<u>INTERNAL</u> / EXTERNAL	
		INTERNAL	Internal trigger
		EXTERNAL	External trigger Pressing the TRIG key samples a datum once.
	Channel setting	Common setting to all channels	

Contact check delay function	Operation details	Sets the duration from when the TRIG signal is input until the start of the contact check.
	Setting range	<u>0 ms</u> to 9999 ms (in increments of 1 ms)
	Channel setting	Separate setting for each channel Start of the current measurement delays using the longest delay time among the settings of all the channels.
Delay function	Operation details	Sets the duration from when the START key is pressed or the TRIG signal is input until the start of measurement.
	Setting range	<u>0 ms</u> to 9999 ms (in increments of 1 ms)
	Channel setting	Common setting to all channels
Average function	Operation details	Averages measured values.
	Setting	<u>OFF</u> / ON (HOLD) / ON (AUTO)
	Number of averaging with averaging set to ON	<u>2</u> to 255 times (Any value in this range can be set.)
	Averaging method	HOLD Moving average (However, arithmetic averages are calculated with the trigger source setting set to the external trigger.) AUTO The number of times of averaging is automatically changed based on the variation of the measured values. (Operated as the HOLD setting for the external trigger setting)
	Channel setting	Common setting to all channels
Power frequency setting	Operation details	Sets the power voltage frequency.
	Setting	<u>AUTO</u> (Automatically detects whether the frequency is 50 Hz or 60 Hz) / 50 Hz / 60 Hz
	Channel setting	Common setting to all channels
Cable length correction function	Operation details	The predetermined length of the cable to be used corrects the fixture capacitance open value and the contact check value. Pressing the F3 key AUTO automatically detects the cable length, incorporating it in the setting value.
	Correctable range	0.5 m to 3.0 m, default: <u>1 m</u>
	Channel setting	Separate setting for each channel
Fixture capacitance open correction function	Operation details	Measures the capacity when the fixture is open. Required to be executed prior to executing the contact check function. The acquired data is retained even when the instrument is turned off.
	Display range	0.000 pF to 99.999 pF
	Open correction value	Measured and retained for each channel independently

Contact check function	Operation details	Judges the contact condition by comparing a measured value with the judgment reference value.
	Operation method	Capacity measurement method by applying a high frequency signal
	Execution method	Outputs measurement signals for each channel separately and using the signals to evaluate objects to be measured on a pass/fail basis for each channel individually.
	Automatic execution	<u>ON / OFF</u> Each channel can have a different setting from others. Simultaneously the [OFF] setting for all the channel starts no contact check automatically.
	Capacity measurement accuracy range	0.200 pF to 95.000 pF (However, the capacity of the objects to be measured shall be equal to or greater than 1/10 of the fixture capacitance.)
	Capacity measurement accuracy	±(20% of the read value ±0.1 pF)
	Judgment reference value input range	<u>0.00 pF</u> to 99.99 pF
	Judgment	GO: (Measured capacity value) > (Judgment reference value) NG: (Judgment reference value) ≥ (Measured capacity value) A measured capacitance of 99.999 pF or higher also results in a GO judgment outputting.
	Variable frequency	<u>300 kHz</u> / 245 kHz (Separate setting for each channel)
	Frequency accuracy	±20%
	Capacitance setting of objects to be measured	LOW / <u>NORMAL</u>
	Manual execution	Measures all channels regardless of whether the setting is ON or OFF for manual execution.
	Self-calibration function	Operation details
Setting		<u>ON</u> / OFF
Setting time		1 s to <u>600 s</u>
Others		Automatically executes the correction once when the instrument is turned on and 5 minutes later regardless of whether the setting is ON or OFF. The correction can be manually executed once from the ON/OFF settings screen. The self-calibration can be executed by sending the command even when the setting is OFF.
Channel setting		Common setting to all channels

Resistivity measurement function	Operation details	The surface resistivity and the volume resistivity are calculated from the electrode constant previously entered.
	Channel setting	Separate setting for each channel
	Setting Items	Surface resistivity (Diameter of the main electrode) / (Internal diameter of the counter electrode) Flat sample volume resistivity (Diameter of the main electrode) / (Thickness of sample) Liquid sample volume resistivity Randomly determined electrode constant Electrode name specification Automatically sets the electrode constant based on the selected electrode.
	Setting range	Diameter of the main electrode (D1) 0.0 mm to 100.0 mm, default: <u>50.0 mm</u> (in increments of 0.1 mm) Internal diameter of the counter electrode (D2) 0.0 mm to 100.0 mm, default: <u>70 mm</u> (in increments of 0.1 mm) Thickness of sample (t) 0.0 mm to 100.0 mm, default: <u>0.1 mm</u> (in increments of 0.1 mm) Electrode constant (K) 0.01 to 999.99, default: <u>500.00</u> (in increments of 0.01)
Calculation formula	Surface resistivity: $\rho_s = \frac{\pi \cdot (D2 + D1)}{D2 - D1} \times (\text{Measured value})$ Flat sample volume resistivity: $\rho_v = \frac{\pi \cdot D1^2}{4t} \times \frac{(\text{Measured value})}{10}$ Liquid sample volume resistivity: $\rho_l = K \times (\text{Measured value})$	
	ρ_s : Surface resistivity Unit [Ω] ρ_v, ρ_l : Volume resistivity Unit [$\Omega \cdot \text{cm}$] π : Circular constant = 3.14 $D1$: Diameter of the main electrode Unit [mm] $D2$: Internal diameter of the counter electrode Unit [mm] t : Thickness of sample Unit [mm] K : Electrode constant Unit [cm]	
Comparator function	Operation details	Compares the set value and measured values, making judgments.
	Setting	ON / OFF
	Judgment	Judgments are made based on the value internally calculated. Hi (Upper limit) < (Measured value) IN (Lower limit) \leq (Measured value) \leq (Upper limit) Lo (Measured value) < (Lower limit)
	Channel setting	Separate setting for each channel
Judgment sound setting function	Operation details	Beeps based on the comparator judgment results. (for each of Hi, IN, and Lo).
	Operation setting, tone color	OFF, Type 1, Type 2, Type 3
	Number of beeps	1 to 5, Continuous
	Channel setting	Common setting to all channels

Panel saving, panel loading	Operation details	Saves and loads the measurement conditions specified by the panel number.
	Numbers of panels	50
	Panel name	10 characters (Alphabets or numbers)
	Saved contents	Measured value display mode, setting of voltage value for resistance calculation, measurement speed, range, trigger mode, delay, average, contact check, self-calibration setting, resistivity measurement settings, comparator, judgment sound, fixture capacitance open correction value
D/A output function	Operation details	Outputs a voltage corresponding to the measured current. Even when a resistance value is displayed, outputs a voltage corresponding to the measurement current.
	Output voltage	0 V DC to 2 V DC (Outputs 2.0 V at the maximum display value of the current range) An error or Current Over Range (out-of-range) results in a voltage of 2.5 V outputting. (Error: zero division, A/D overflow) Negative current values result in a zero-volt output.
	Maximum output voltage	5 V DC
	Output impedance	1 k Ω
	Number of bits	12 bits
	Output terminal	BNC terminal
	Output channel setting	<u>1</u> CH / 2CH / 3CH / 4CH
	Reset function	Reset
System reset		Resets all the settings including the panel data to the factory default.
Self-test function	Self-test on start-up	Executes the ROM/RAM check.
Error display	See "Error display and solution" (p. 136).	
GO signal logic-level inverting function	Operation	Inverts logic levels of contact-check result signals When the contact check is set to ON Outputs the On signal for a pass judgment with the [NORMAL] setting. Outputs the Off signal for a pass judgment with the [INVERT] setting. Always gives fail judgments and thus outputs the Off signal.
	Setting	<u>N</u> ORMAL/ <u>I</u> NVERT

Measurement timing

Trigger measurement (example of one channel)

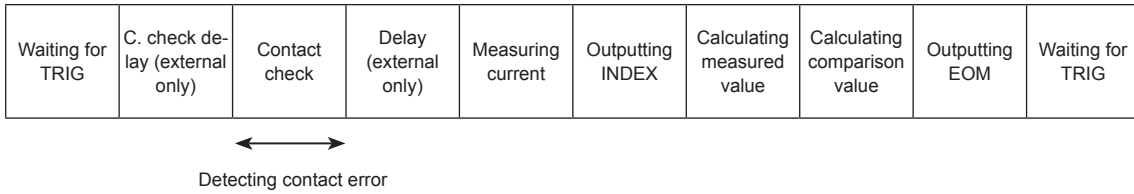

When contact check delay times of channels are different from each other

• Trigger measurement (one channel)

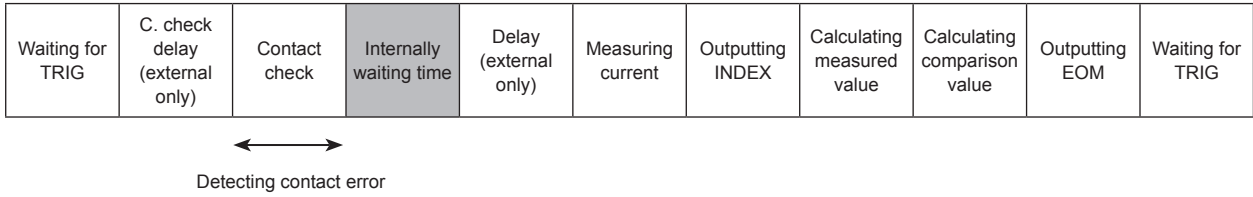

• Trigger measurement (two channels)

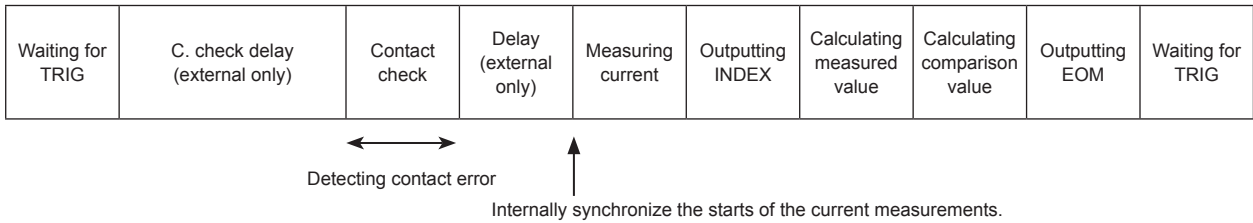

- If a contact error occurs, the subsequent process continues.
- Even if contact check delay times of channels are different from each other, the measurement start times are synchronized (each channel will have its own time from the contact check to the measurement).

11.4 Interface Specifications

The underlined values are the default settings. The set values are retained even after the instrument is turned off.

USB	Communication contents	Remote control, measured value output
	Connector	Series B receptacle
	Electrical specifications	USB2.0 (Full Speed)
	Class (mode)	<u>CDC class (COM mode: COMM)</u> HID class (USB keyboard mode: KEYBOARD)
RS-232C	Communication contents	Remote control, measured value output
	Transmission method	Start-stop synchronization system, full duplex
	Transmission speed	4800 bps / <u>9600 bps</u> / 19200 bps / 38400 bps / 115200 bps
	Data bit length	8 bits
	Stop bit	1
	Parity bit	None
	Delimiter	Sending: CR + LF; Receiving: CR, CR + LF
	Handshake	X flow: Not provided, Hardware flow: Not provided
	Protocol	Non-procedure system
	Connector	D-sub 9 pins, male, mating fixed base screw #4-40
GP-IB	Communication contents	Remote control
	Device address	0 to 30, default: <u>1</u>
	Delimiter	<u>LF</u> / CR + LF
	Other	IEEE488.2 compliant
Interface functions		
SH1	Provides all source handshake functions.	
AH1	Provides all acceptor handshake functions.	
T6	Provides a basic talker function. Provides a serial poll function. Does not provide a talk-only mode. Provides a function to release the talker using the MLA (My Listen Address).	
L4	Provides a basic listener function. Does not provide a listen-only mode function. Provides a function to release the listener using the MTA (My Talk Address).	
SR1	Provides all service request functions.	
RL1	Provides all remote/local functions.	
PP0	Does not provide parallel poll functions.	
DC1	Provides all device clear functions.	
DT1	Provides all device trigger functions.	
C0	Does not provide a controller function.	

Remote functions	Operation details	If communication is performed through RS-232C, USB or GP-IB, the function changes the instrument status to remote and disables the key operation from the front panel. To deactivate the remote control, follow the ways listed below: <ul style="list-style-type: none"> • Press the LOCAL key. • Turn off the instrument and turn it on again. • Execute the command :SYSTem:LOCa1 through RS-232C, USB or GP-IB. • Execute the command GTL through GP-IB.
	Communication monitor function	Operation details
	Setting	ON / <u>OFF</u> (settable using panel or with communication)
Data output function	Operation details	With the trigger mode set to EXT: Outputs measured values when the TRIG signal is input or the ENTER (TRIG) key is pressed. With the trigger mode set to INT: Automatically outputs measured values every time measurement is completed.
	Setting	ON / <u>OFF</u>
Memory function	Operation details	Stores the measured data in the memory. Collectively sends the saved measured values.
	Number of memories	999 (volatile memories without backup)
	Setting	ON / <u>OFF</u>

11.5 External I/O Specifications

The underlined values are the default settings. The set values are retained even after the instrument is turned off.

Input signal	Signal type	TRIG, C_CHECK, OPEN, START, STOP, CLEAR, KEYLOCK
	Photo-coupler isolation	Non-voltage contact inputs (Supports current sink/source output)
	Input on	Residual voltage: 1 V or less (Input on current 4 mA [value for reference])
	Input off	Open-circuit (Breaking current: 100 μ A or less)
	Response time	On edge: 0.1 ms at a maximum, off edge: 1.0 ms at a maximum
Output signal	Signal type	EOM, INDEX, C_CHECK_GO (1) through C_CHECK_GO (4), OPEN_GO, HI (1) through HI (4), IN (1) through IN (4), LO (1) through LO (4), ERR
	Photo-coupler isolation	Open drain output (Non-polar)
	Maximum load voltage	30 V DC Residual voltage: 1 V or less (load current: 50 mA) / 0.5 V or less (load current: 10 mA)
	Maximum output current	50 mA/channel
Output signal setting	Operation details	Sets the output of EXT I/O to current sink (NPN) or current source (PNP).
	Setting	<u>NPN</u> / PNP
	Setting method	Switches the setting using the rear switch. (Commands cannot be used for switching the setting.)

TRIG filter function	Operation details	Processes signals only when the input signal remains in the on state during the response time.
	Setting	ON / <u>OFF</u>
	Response time	<u>1 ms</u> to 500 ms
TRIG logic setting	Operation details	Sets the start edge for the TRIG signal.
	Setting	<u>ON edge</u> / OFF edge
EOM output timing setting	Operation details	Setting the output mode to HOLD leaves the EOM signal outputting in the on state until the next TRIG signal. Setting the output mode to PULSE leaves the EOM signal outputting in the off state after the period of the set pulse width has elapsed.
	Setting	<u>HOLD</u> / PULSE
	Pulse width	<u>1 ms</u> to 100 ms (Accuracy: $\pm 1\%$)
EXT I/O test function	Operation details	Displays the input signal status of EXT I/O, and optionally outputs an output signal.
Service power supply output	Output voltage	Sink output: 5.0 V $\pm 10\%$ Source output: -5.0 V $\pm 10\%$, 100 mA at a maximum
	Insulation	Floated from the protective ground potential and the measurement circuit.
	Insulation rating	Voltage to ground 50 V DC, 30 V rms AC, 42.4 V peak AC or less
Connector	D-sub 37 pins, female, mating fixed base screw #4-40	
Pin assignment	See "Instrument-side connector pin assignment" (p. 91).	
Functions of input signal	See "Input signal" (p. 93).	
Functions of output signal	See "Output signal" (p. 93).	

12.1 Troubleshooting

If damage is suspected, check the "Q&A (Frequently Asked Questions)" section before contacting your authorized Hioki distributor or reseller.

Q&A (Frequently Asked Questions)

General items

No.	Troubleshooting	Confirm	Possible causes, solution	Reference	
1-1	The instrument cannot be turned on (nothing is displayed).	Power switch (Rear)	OFF	The power is not supplied. → Flip the power switch (rear).	p. 31
			ON	The power is not supplied. → Check the conduction of the power cables. → Check if the breaker for the equipment is switched on.	p. 31
				The power voltage or frequency is different. → Check the power rating. (100 V to 240 V, 50 Hz / 60 Hz)	—
				The screen is dark. → Adjust the backlight brightness and contrast.	p. 84
1-2	The keys cannot be operated.	Display	[K.LOCK] is displayed. → Deactivate the key lock.	p. 80	
			[RMT] is displayed. → Deactivate the remote control.	p. 118	
1-3	Judgment results are not displayed.	Measured value	is displayed. → Set the function to ON.	p. 69	
			is not displayed. (Non-values are displayed)	If measured values are not displayed, judgment is not done and the indicator is not displayed.	—
1-4	Buzzer cannot be heard.	Key operation tone setting	OFF → Set the function to ON.	p. 79	
		Judgment sound setting	OFF → Set the function to ON.	p. 71	
1-5	I want to adjust the buzzer volume.	The buzzer volume cannot be adjusted for this instrument.		—	
1-6	The measured values are not displayed.	Run self-calibration. If an error is displayed, internal damage may have occurred. Contact your authorized Hioki distributor or reseller.		p. 47	

Measurement items

No.	Troubleshooting	Confirm		Possible causes, solution	Reference
2-1	Measured values are not stable.	Measurement leads	Self-built	Electromagnetic induction affects the measured values. → Guard the cable, as close as possible to the measured object.	p. Appx.11
		Measured object	Temperature has not been stabilized.	Characteristics have changed depending on the temperature. → Perform measurements after the fluctuation in temperature becomes moderate.	–
		Humidity sensor	is not inserted all the way in.	The Humidity Sensor is not correctly connected. → Insert the Humidity Sensor all the way in.	p. 29

EXT I/O items

No.	Troubleshooting	Confirm		Possible causes, solution	Reference
3-1	The instrument does not operate at all.	Does the EXT I/O test result, which is the status of the input and the output displayed on the instrument, match with that of the controller?		Wiring etc. is incorrect. → Check the EXT I/O for the following: <ul style="list-style-type: none"> • Loose connection of the connectors • Pin numbers • Wiring of the ISO_COM terminals • NPN/PNP settings • Contact (or open collector) control (Not controlled by voltage) • Power supply to the controller (Power to the instrument is not required.) 	p. 90
3-2	Trigger is not applied.	Trigger source		The trigger mode is set to the internal trigger. → Set it to the external trigger.	p. 46
		Is the on-state time of TRIG more than 0.1 ms?		The on-state time of TRIG is insufficient. → Ensure an on-state time of 0.1 ms or more.	–
3-3	EOM is not output.	Are the measured values updated?		Check Q&A in 3-2.	–
		EOM signal logic		The EOM signal will be in the on state once the measurement is completed.	p. 93
3-4	HI, IN, and LO signals are not output.	Are the judgment results displayed on the instrument screen?		Check Q&A in 1-3.	p. 133

Communication items

The operation can be checked smoothly by using the communication monitor (p. 116).

No.	Troubleshooting	Confirm	Possible causes, solution	Reference
4-1	The instrument refuses to respond.	Display	[RMT] is not displayed. Connection cannot be established. → Check the connector insertions. → Check that the settings of the interfaces are correct. → Before using the USB, install drivers in the control instruments. → Use the cross cable when RS-232C is used. → Check the COM port number of the control instrument. → Match the communication speed of the instrument to that of the control instrument.	p. 109
			[RMT] is displayed. Commands are not accepted. → Check the delimiter of the software.	p. 109
4-2	Results in an error.	Display	Results in a command error. Commands are incorrect. → Check the spelling of the commands. (A space is represented as the numeric character reference x20H.) → Eliminate question marks (?) from commands with no query. → Match the communication speed of the instrument to that of the control instrument.	*1
			Results in an execution error. The input buffer (256 bytes) overflows. → Wait until the received character strings are processed. Example: Insert dummy queries, e.g., sending *OPC? and receiving "1," every time several lines of commands are sent.	
4-3	A response to the query is not returned.	On the communication monitor	There is a response. The program is not correct. → The instrument returned the query. Check the receiving part of the program.	

*1: For details, refer to the Communication Command Instruction Manual on the accompanying CD.

Error display and solution

System errors (requiring repair)

Error No.	Display	Cause	Solution
ERR:001	Backup data error	Backup data error	Malfunctions occur in the instrument. Request repairs.
ERR:002	RAM error	CPU RAM error	
ERR:003	Memory read/write error	Memory read/write error	
ERR:004	Calibration error	Calibration error in the current measurement block	
ERR:005	A/D communication error	A/D communication error	
ERR:006	Measurement function error	Error in the internal communications with the measurement block	
ERR:009	Power line detection error	Power frequency detection error	
ERR:012	Adjustment data error	Adjustment data error	
ERR:013	ROM check sum error	Program ROM check sum error	

Function errors

Error No.	Display	Cause	Solution
ERR:101	Command error	The command is not correct.	Check an incorrect command. Refer to Communication Command Instruction Manual in the accompanying CD.
ERR:102	Execution error	The command cannot be executed.	
ERR:103	Parameter error	The parameter part of the command is not correct.	Check an incorrect parameter. Refer to Communication Command Instruction Manual in the accompanying CD.
ERR:110	LOW LIMIT is higher than UPP LIMIT.	The lower limit value is greater than the upper limit value in the comparator setting.	Check an incorrect comparator setting. See "6 Judging Measured Value (Comparator Function)" (p. 69).
ERR:111	Keylocked. Press [UNLOCK] 1 sec to unlock.	The key lock is activated.	Press and hold the MENU key for more than one second to deactivate the key lock.
ERR:113	Can not set this speed. Please change valid range.	The specified measurement speed cannot be set with the present range setting.	Change the range to another, and then change the measurement speed. See "Current measurement accuracy" (p. 121).
ERR:114	Can not set this range. Please change valid speed.	The specified range cannot be set with the present measurement speed setting.	Change the measurement speed to another, and then change the range. See "Current measurement accuracy" (p. 121).

Measurement errors

Error No.	Display	Cause	Solution
None	Current Over Range	The measured value exceeds the current measuring range.	Set the correct range.
None	+Over°C	The measured value exceeds the temperature measuring range. The measuring range is from -40.0°C to 80.0°C.	The temperature is too high to be measured with this instrument.
None	-Over°C	The measured value is lower than the temperature measuring range. The measuring range is from -40.0°C to 80.0°C.	The temperature is too low to be measured with this instrument.
None	Over%rh	The humidity value exceeds the humidity measuring range. The measuring range is from 0.0% RH to 90.0% RH.	The relative humidity is too high to be measured with this instrument.

Other errors

Error No.	Display	Cause	Solution
None	--.-°C	The Humidity Sensor is not connected.	Connect the Humidity Sensor to the instrument.
None	--.-%rh	The Humidity Sensor is not connected.	Connect the Humidity Sensor to the instrument.

12.2 Calibrations, Replaceable Parts, Cleaning, and Disposal

WARNING



Touching any of the high-voltage points inside the instrument is very dangerous. Customers are not allowed to modify, disassemble, or repair the instrument. Doing so may cause fire, electric shock, or injury.

Calibrations

The calibration period varies depending on the status of the instrument or installation environment. We recommend that the calibration period be determined in accordance with the status of the instrument or installation environment. Please contact your Hioki distributor to have your instrument periodically calibrated.

Backing up the data

The instrument may be initialized (The factory default settings may be restored) when it is repaired or calibrated.

Before you ask for repair or calibration, it is recommended to back up (save or record) the measurement conditions and measured data.

For information about how to back up data, see the abridged manual that accompanies the SM Sample Application Manual, which can be downloaded from Hioki's website.

Replaceable parts and service life

The characteristics of some of the parts used in the product may deteriorate when used for a long time. To ensure the product can be used over the long term, it is recommended to replace these parts on a periodic basis.

When replacing parts, please contact your authorized Hioki distributor or reseller. The service life of parts varies with the operating environment and frequency of use. Parts are not guaranteed to operate throughout the recommended replacement cycle.

Part name	Recommended replacement cycle	Remarks/conditions
Electrolytic capacitors	Approx. 3 years	The circuit board on which the corresponding part is mounted will be replaced.
LCD backlight (Brightness half-life)	Approx. 10 years	When the backlight is used for 24/7 × 365 days
Relay	Approx. 3 years	When the range is switched 30 times/h

Cleaning

CAUTION



Clean the vents periodically to avoid blockage. If a vent becomes clogged, the instrument's internal cooling is impeded, and damage may result

- To clean the instrument, wipe it gently with a soft cloth moistened with water or mild detergent.
- Wipe the LCD gently with a soft, dry cloth.

Disposal

Handle and dispose of the instrument in accordance with local regulations.

Appendix

Appx. 1 Internal Circuits

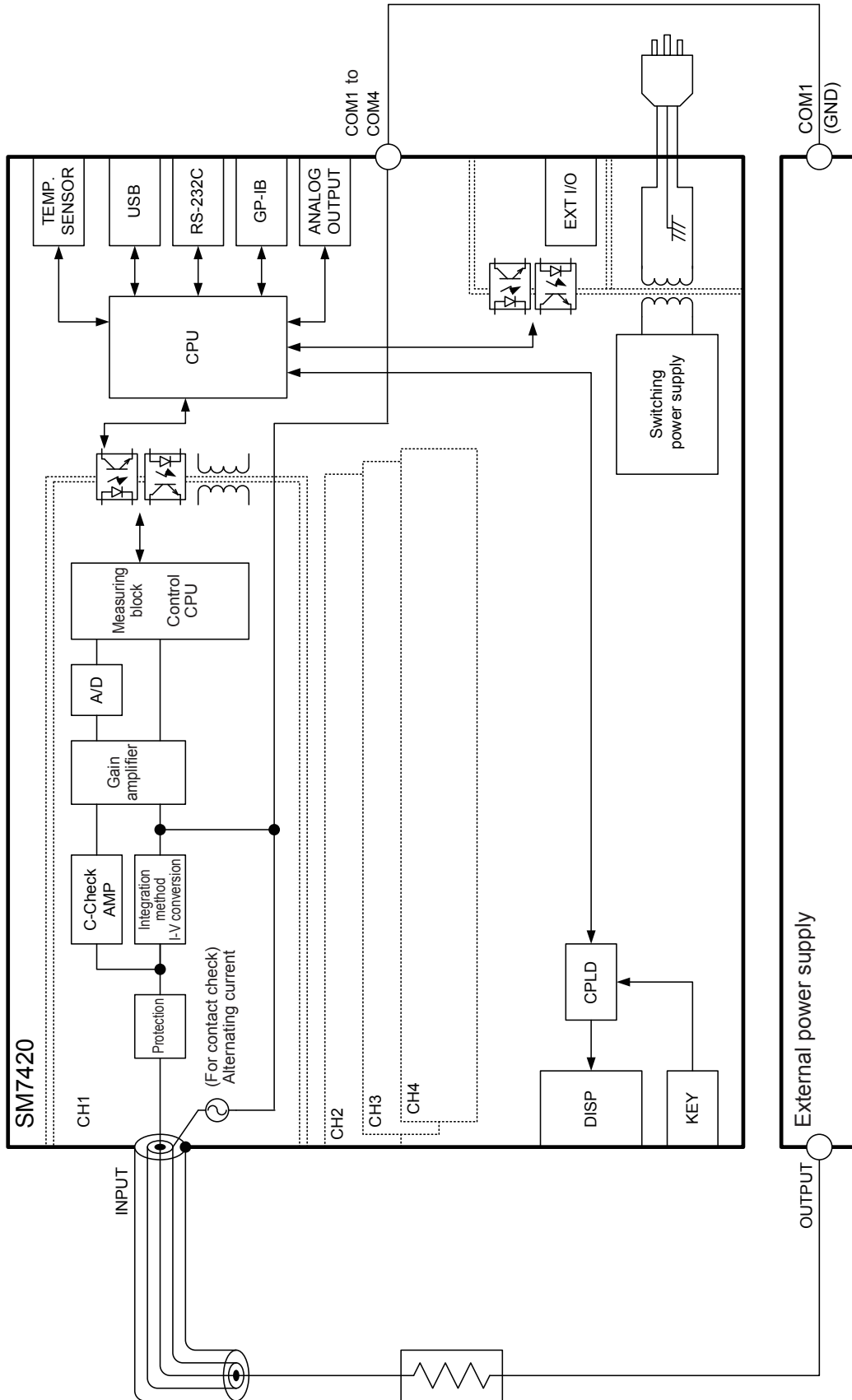

Appx. 2 Changes in Current Running through Insulator

When measuring insulation resistance, a large current flows as a voltage is applied, and gradually the current becomes smaller, not reaching a constant value.

This is caused by charge current, absorption current, and leak current, and is generally called dielectric absorption. The equivalent circuit of an insulator is shown in Figure 1. In this figure, applying a voltage generates charge currents flowing through the capacitance $C_0, C_1, C_2, \dots, C_n$. First, these currents charge C_0 , and then C_1, C_2, \dots, C_n in order. As the charging progressed, the currents become smaller, resulting in only a leak current flowing through R_0 remaining. (See Figure 2.)

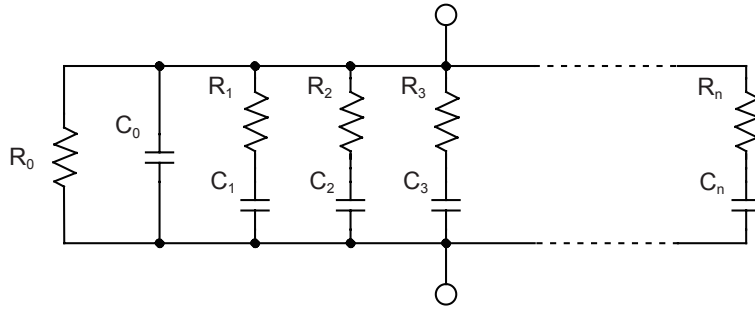

Figure 1 Equivalent Circuit of the Insulator

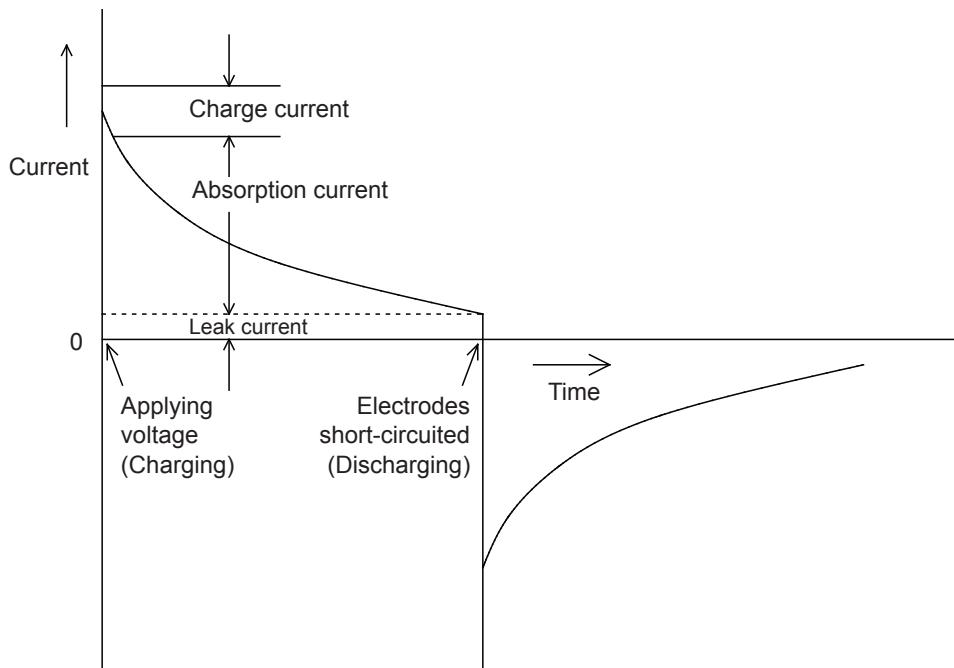

Figure 2 Dielectric Absorption

R_0 is the insulation resistance. Because the high resistance R_1, R_2, \dots, R_n are connected in series respectively with C_1, C_2, \dots, C_n , it is difficult to measure R_0 separately.

It is generally said that the time until convergence can be several hours to several days. Therefore, the resistance 1 minute after applying voltage is considered as the insulation resistance. It is called 1-minute insulation resistance, and is widely used in standards.

When measuring the 1-minute insulation resistance, the first value differs from the second or third consecutively measured values, so be sure to discharge the object with a voltage applied before a measurement.

It also depends on the amount of voltage across C_0 shown in Figure 1; however, discharging the capacitance generally requires a period 5 to 6 times as long as the voltage-applying time during the measurement.

Appx. 3 Countermeasures Against Noise

(1) Effects of induction noise

A lot of noise is generated from power cords, fluorescent lights, solenoid valves, and computer displays. Below are noise sources that may affect resistance measurement.

1. Electrostatic coupling between a high-voltage line and a measurement lead
2. Magnetic coupling between a high-current line and a measurement lead

Electrostatic coupling between a high-voltage line and a measurement lead

Current that flows in from a high-voltage line is controlled by electrostatic capacitance coupled with a measurement lead.

For example, if a 100 V commercial power line and a resistance measurement lead are electrostatically coupled with a capacitance of 1 pF, a current of approximately 38 nA is induced.

$$I = \frac{V}{Z} = 2\pi \cdot 60 \cdot 1 \text{ pF} \cdot 100 \text{ V}_{\text{RMS}} = 38 \text{ nA}_{\text{RMS}}$$

If a 1 Ω resistor is measured with a measurement current of 100 mA, the effect reaches to only 0.4 ppm of the measured value and may be ignored. If a resistance of 1 M Ω is measured with a measurement current of 10 μA , the effect is only 0.38% to the measured value. For high resistance measurement, care should be exercised for electrostatic coupling between the high-voltage line and the measurement lead. Shielding measurement leads and objects to be measured electrostatically is effective (Figure 1).

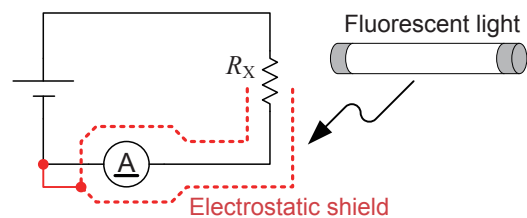

Figure 1 Electrostatic shield close to high-voltage wiring

Magnetic coupling between a high-current line and a measurement lead

A magnetic field is generated from a high-current line. An even larger magnetic field is emitted from transformers and choke coils with a lot of turns. A voltage induced by the magnet field is affected by distance and surface area. A loop with an area of 10 cm² placed 10 cm away from a commercial power line carrying a current of 1 A generates a voltage of 0.75 μV .

$$\begin{aligned} v &= \frac{d\phi}{dt} = \frac{d}{dt} \left(\frac{\mu_0 IS}{2\pi r} \right) = \frac{4\pi \cdot 10^{-7} \cdot fI}{r} \\ &= \frac{4\pi \cdot 10^{-7} \cdot 60\text{Hz} \cdot 0.001 \text{ m}^2 \cdot 1\text{A}_{\text{RMS}}}{0.1 \text{ m}} = 0.75 \mu\text{V}_{\text{RMS}} \end{aligned}$$

If a 1 m Ω resistor is measured with a measurement current of 1 A, the effect is 0.07% of the measured value. With high resistance measurements, there is no issue because the detection voltage can be increased easily.

Twisting each pair of voltage detection leads, which are for resistance measurement, and noise generating lines in addition to separating the pairs from each other will effectively decrease the impact of magnetic coupling (Figure 2).

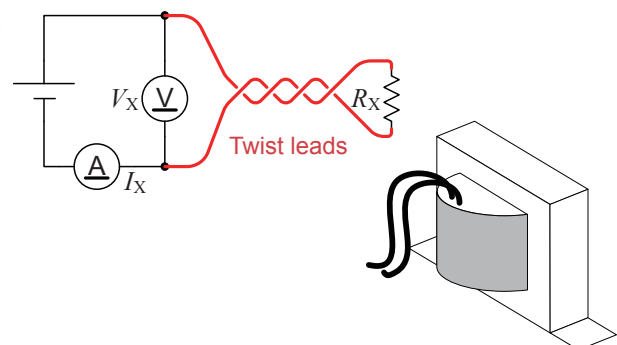

Figure 2 Twist leads close to a high-current line

Countermeasures for the instrument against induction noise

Attaching a ferrite core around a measurement lead as shown in Figure 3 is effective.

In addition to taking the countermeasure for the instrument, twisting the surrounding noise-generating large current wires and shielding the high-voltage wires are even more effective.

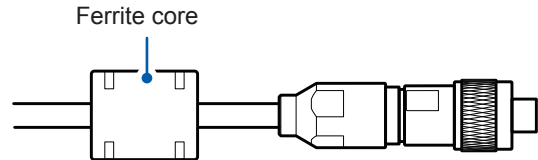

Figure 3 Ferrite core

If the induction noise is caused by a commercial power

Induction noise caused by a commercial power is not only generated from commercial power lines and power outlets, but also fluorescent lights and household electronics. Noise caused by the commercial power depends on the frequency of the commercial power, and is generated at a frequency of 50 Hz or 60 Hz.

To reduce the effect of noise caused by this commercial power, generally the reset time is set to an integral multiple of the power cycle (Figure 4).

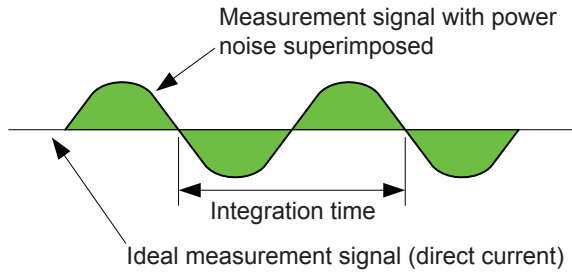

Figure 4 Noise caused by the commercial power

The measurement speed of the instrument has the following five options: FAST, FAST2, MED, SLOW, and SLOW2. For high resistance and low resistance measurement, measured values may not be stable. In that case, you should reduce the measurement speed or take actions against the noise.

If the instrument is operated on AC with a frequency of 50 Hz while the power frequency setting is set to 60 Hz, the reset time will not be synchronized with the power cycle, and the measured values will be fluctuated. Check the power frequency settings.

(2) Effects of conductive noise

Aside from induction noise superimposed on a measured object or measurement leads, conductive noise can invade via another path. Conductive noise refers to noise superimposed on control lines such as power lines and USB cables.

Various equipment is connected to a power line such as motors, welding machines, inverters, etc. While this equipment is running, or when it is turned on or off, a significant spike will flow through the power line. Due to this spike current and impedance of the power line, a large spike voltage can be generated in the power line and ground line of the power, resulting in effects on the measurement instrument. Similarly, noise may also be injected from control lines of the controller. Noise that penetrates from the power of the controller, or generated from a DC-DC converter installed the controller, penetrates the measurement instrument through a USB cable or EXT I/O wire (Figure 5).

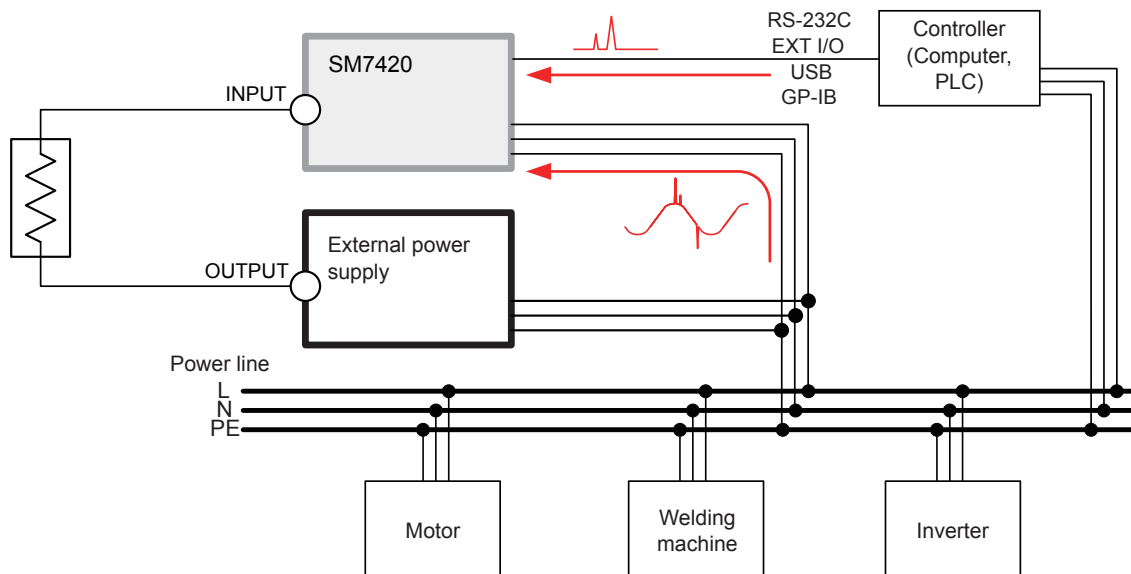

Figure 5 Conductive Noise Penetration

Conductive noise can be monitored with the Hioki 3145 Noise HiLogger while measures are taken. If the penetration path has been specified, follow the measures shown in Figure 6.

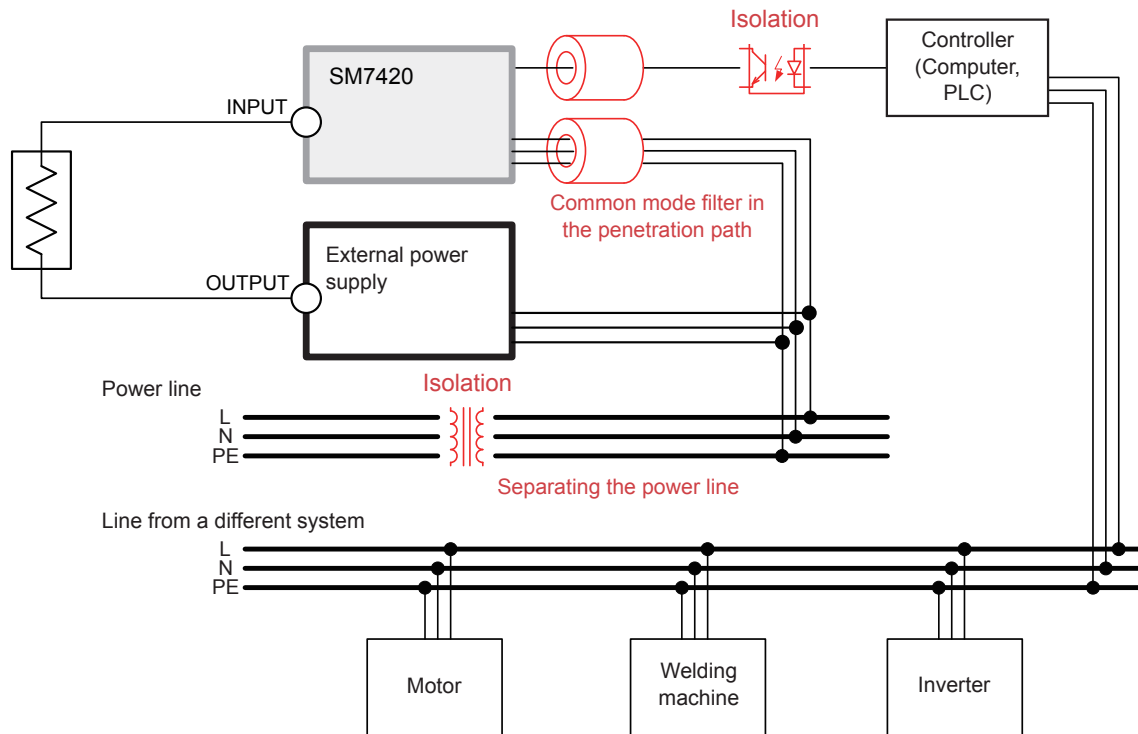

Figure 6 Conductive Noise Countermeasures

Separating the power line

It is best to connect power systems and welding machines to a power from a different system than the instrument.

Install the common mode filter (EMI choke) to the penetration path.

Common mode filters are more effective if you choose ones with high-impedance and install several of them.

Insulation

Optically isolating the control line will improve the susceptibility to noise.

In Addition, optically isolating the power line with a noise-cut transformer will improve the susceptibility to noise improves. However, keep in mind that if the ground line is shared by the source side wiring of the transformer and the load side wiring of it, the effect may be diminished.

Appx. 4 Using Instrument with 2000 V or Higher Voltage Applied (With External Power Supply)

Be sure to read “Before performing a measurement” (p. 11) beforehand.

1 Connect the object to be measured and the other devices to the instrument as follows.

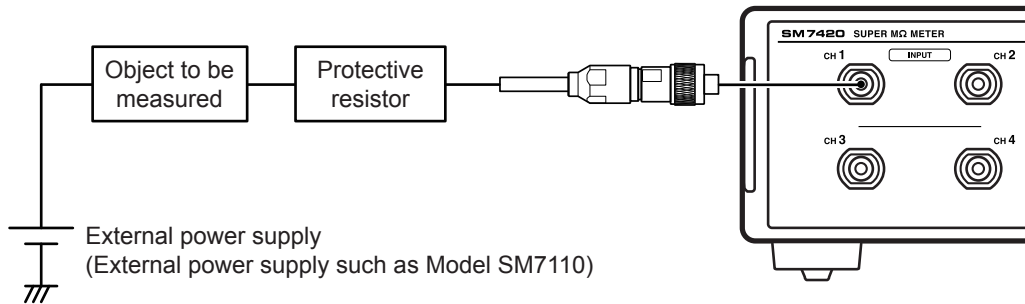

When using Model SM7110 or SM7120 as an external power supply, wire the system as follows: Connect the shorting plug to the GUARD terminal and the GROUND terminal. Connect an object to be measured to the OUTPUT terminal of Model SM7110/SM7120. Connect the GUARD terminal of Model SM7110/SM7120 and the COM terminal of Model SM7420 with each other.

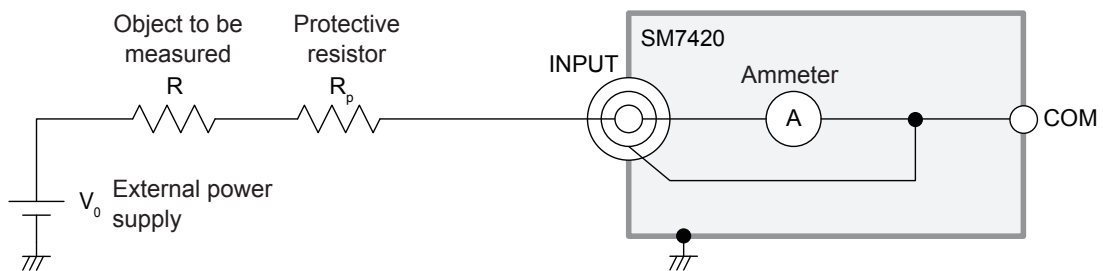

When using the external power supply, insert a protective resistor so that a current flowing through the instrument is reduced to the rated current or less even if the terminals of the object to be measured are short-circuited with each other.
 Test using a measurement voltage of 1000 V or less: 50 mA or less
 Test using a measurement voltage exceeding 1000 V: 1.8 mA or less

2 Configure the instrument setting as follows:

Trigger: Internal trigger (INT) (p. 46)

Voltage value setting for resistance calculation: (p. 35)

3 Turn on the external power supply.

4 Connect the measurement leads to the object to be measured.

5 Apply a voltage from an external power supply.

6 Press the **START** key.

A measurement starts.

Determining protective resistance

See “Current-limiting resistor” (p. Appx.10).

Appx. 5 Assembling Switching Unit for Object to Be Measured

To improve the operating efficiency of the insulation resistance measurement, you can assemble a switching device for the following cases:

- Measuring multiple objects in series, selecting the objects to be measured with relays
- Measuring an object that has multiple measurement points by selecting any two measurement points in series with relays

To measure objects precisely, consider various factors when assembling the switching device.

This chapter describes the following contents.

- Procedure for connecting objects to be measured and switching units to the instrument
- Precautions for selecting relays that are to be installed in the switching unit
- Circuit diagram of the switching unit
- Procedure for assembling the switching unit

Connecting objects to be measured and the switching unit to the instrument

Two methods are available depending on the status of the objects to be measured.

If the objects to be measured are grounded

Because the OUTPUT terminal of the external power supply is grounded, connect the switching unit to the INPUT terminal.

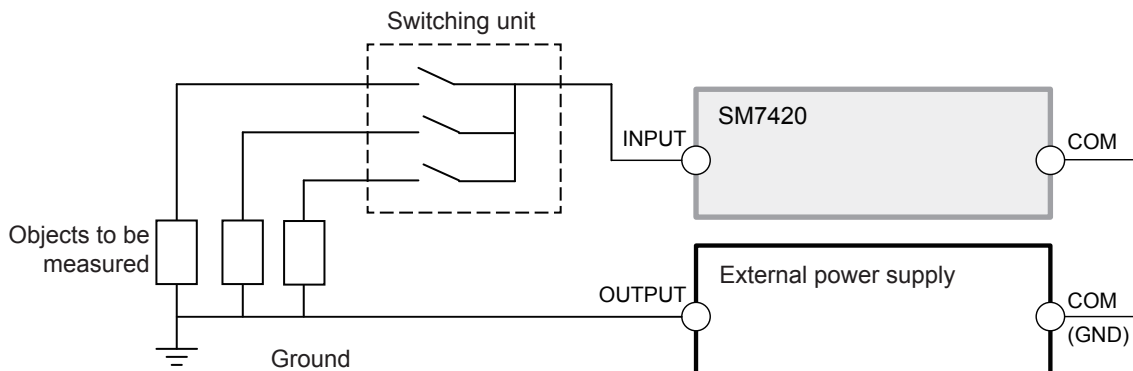

If the object to be measured are not grounded

Measurement can be performed using the same method given in "If the objects to be measured are grounded," but you can also measure objects with the switching unit connected to the OUTPUT terminal as follows.

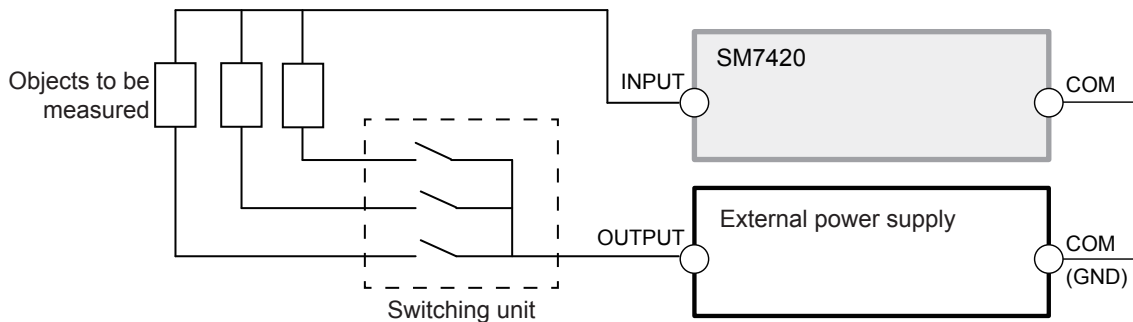

Selecting relays to be installed in the switching unit

Important specifications for relays

Switching voltage and dielectric strength

“Maximum switching voltage” and “dielectric strength between contacts and between a contact and a coil” must be sufficiently high with respect to the instrument’s set voltage.

Switching current

Select relays with switching currents that are high enough relative to a current flowing even if the terminals of a measured object are short-circuited with each other.

In addition, the rated maximum current of the relays must be higher than a transient surge current, which is generated at the moment when contacts close and open.

Thus, generally you should include a resistor that limits the current in series with the relay as close to as possible.

Insulation resistance

An insulation resistance between contacts and that between a contact and a coil must be high enough to be negligible with respect to the insulation resistance of an object to be measured (1000 times greater or more). For example, if the insulation resistance of the object to be measured is 100 MΩ, use a relay with an insulation resistance 100 times greater or more (10,000 MΩ or more) than the insulation resistance of the object to be measured. (If 100 times greater, the error from connecting the switching device to the instrument will be 1% of a measured value; and if 1000 times, 0.1%.)

Shape, structure

An ideal structure of a relay is such that its contacts are pulled out with a lead wire, and the contacts and coil are shielded with each other.

For a plug-in type relay, an insulation resistance between pins installed in a relay socket themselves are included in parallel with a space between contacts in the relay, resulting in the negative effect that measured insulation resistance values are lower than expected.

In addition, for the plug-in type relay, long-term use leads to the socket being covered with dirt due to the dust attraction effect of high voltage, and causes insulation deterioration.

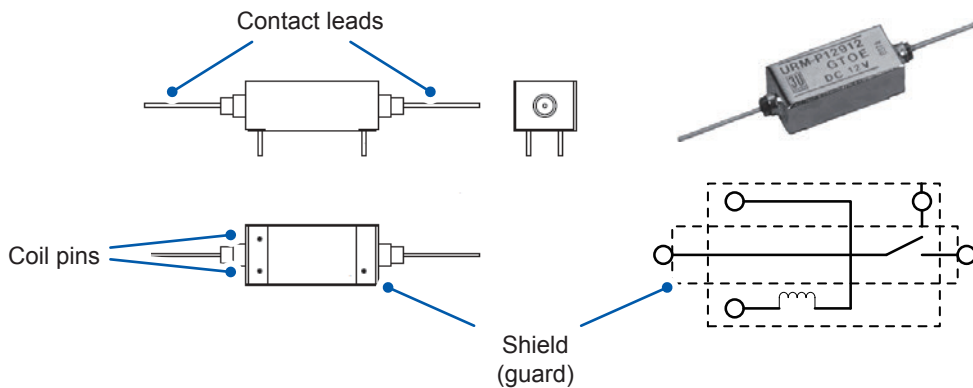

Example (measurement voltage is 350 V or less)

Manufacturer:	Sanyu Electric, Inc.
Model:	URM series
Maximum switching voltage:	350 V
Maximum switching current:	0.5 A
Insulation resistance between contacts:	$10^{13} \Omega$ or $10^{14} \Omega$ can be specified
Between contact and guard:	Same as above
Between coil and guard:	$10^{11} \Omega$

Circuit diagram of the switching unit

To connect between the measurement leads and the instrument or between the leads and objects to be measured, employ the connectors that are custom-made by Hioki for use with the Super Megohm Meter. In addition, as for the cables between the instrument and the switching unit and between the switching unit and objects to be measured, employ the cables that are custom-made by Hioki for use with the Super Megohm Meter.

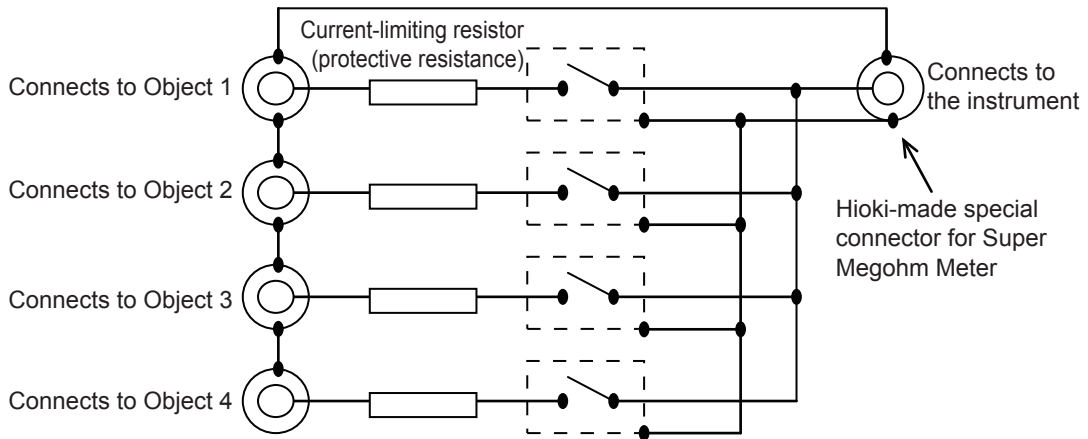

Including current-limiting resistor (protective resistance) and relay

Guard and shield

When connecting a relay and a current-limiting resistor (protective resistance) to the instrument, pay attention to the guard and shield.

See the following example (The guard prevents DC interfering currents from flowing, whereas the shield prevents AC interfering currents from flowing).

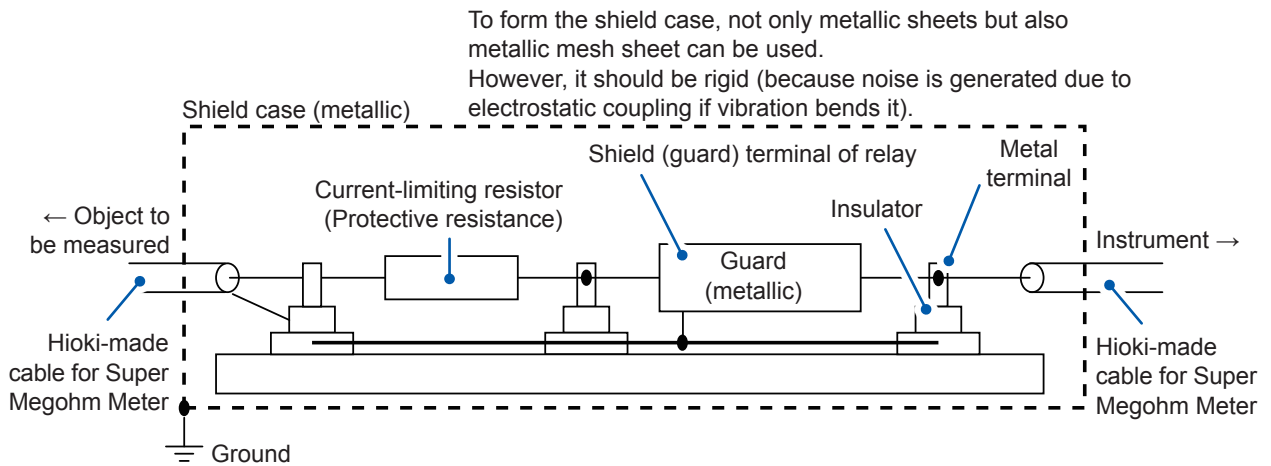

Example of terminal for adding relay and resistor

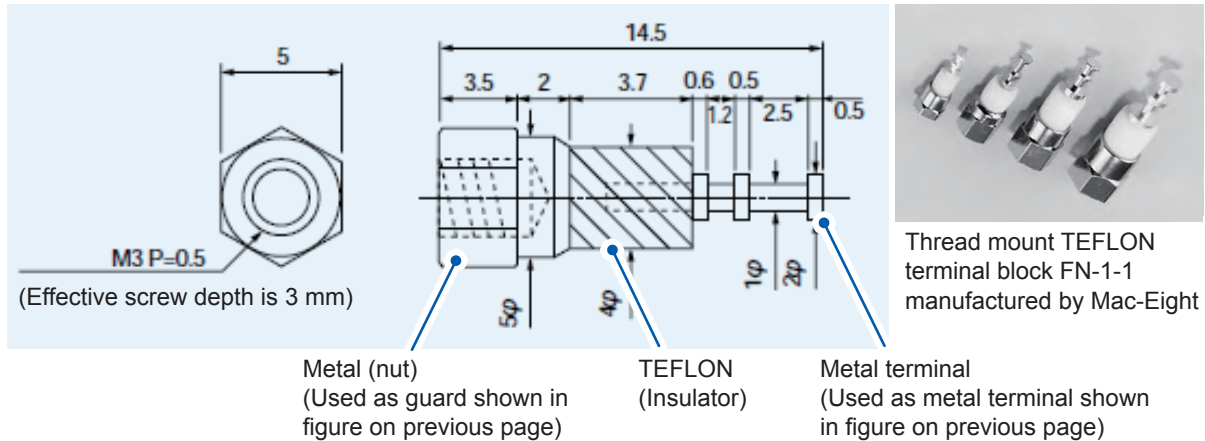

Current-limiting resistor

Resistance value

Decide resistance values of current-limiting resistor as follows:

- (1) Resistors shall be low enough to be negligible relative to the insulation resistance of objects to be measured; however, be as high as possible.
- (2) The value equivalent to 20 times the time constant with respect to the electrostatic capacity component of an object to be measured shall be short enough relative to the measurement time.

For example, if you want to measure the insulation resistance of 10,000 MΩ with a electrostatic capacitance of 1,000 pF for 5 sec, the resistance value can be determined in the following manner:

Considering Item (1), the current limit resistance is calculated from the following expression:

$$10000 \times 106 \div 1000 = \text{Approximately } 10 \text{ M}\Omega$$

The measurement time is calculated, as described in Item (2), from the following expression:

$$10 \text{ M}\Omega \times 1,000 \text{ pF} \times 20 = 0.02 \text{ sec}$$

Because this time is considered to be short enough compared to 5 seconds, a resistance of 10 MΩ is acceptable as the current-limiting resistance.

Selecting resistor

Refer to the specifications of current-limiting resistors to check if the maximum working voltages of them are higher than the set voltage of the instrument.

In addition, resistances with power ratings that are high enough relative to a current flowing even if the terminals of an object to be measured are short-circuited with each other.

For example, for a 10 MΩ current-limiting resistor and a set voltage of 250 V, if the terminals of the object to be measured are short-circuited with each other, the load power is calculated from the following expression:

$$250 \text{ V} \times 250 \text{ V} \div 10 \text{ M}\Omega = 0.00625 \text{ W}$$

Considering heat generated by resistance, in general, power ratings 5 times or more of the load power is required. (ideally 10 times)

(Example: KOA high voltage high resistance thick film resistor GS1/2 10 MΩ)

Determine a current-limiting resistor so as to limit the current flowing into the instrument to the current rating.

Testing using a measurement voltage of 1000 V or less: 50 mA or less

Testing using a measurement voltage exceeding 1000 V: 1.8 mA or less

The current is calculated from the following expression:

$$250 \text{ V} \div 10 \text{ M}\Omega = 25 \mu\text{A}$$

The resistance value, which meets the condition above, is proved to be acceptable.

Appx. 6 Modifying Measurement Lead

When modifying the tip of the Hioki-made measurement lead, follow the procedure below:

When stripping off the jacket or braided conductor, take care not to break the wires or short-circuit them with each other.

We will not guarantee the accuracy of measured values obtained using measurement leads modified by users.

Structure of shielding wire of Hioki-made measurement leads

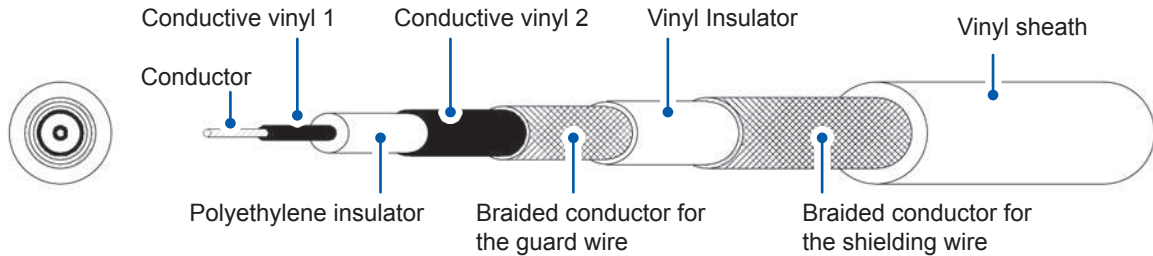

Item	Thickness (Approx.)	Diameter (Approx.)	
Conductor	–	0.54 mm	
Conductive vinyl 1	0.23 mm	1.00 mm	
Polyethylene insulator	0.85 mm	2.70 mm	
Conductive vinyl 2	0.22 mm	3.15 mm	
Braided conductor for the guard wire	0.25 mm	3.65 mm	
Vinyl Insulator	0.35 mm	4.35 mm	
Braided conductor for the shielding wire	0.25 mm	4.85 mm	
Vinyl sheath	1.05 mm	7.00 mm	+0.0 mm
			-0.2 mm

Modifying the tip of measurement leads

- 1 Strip off the jacket with a knife, etc.

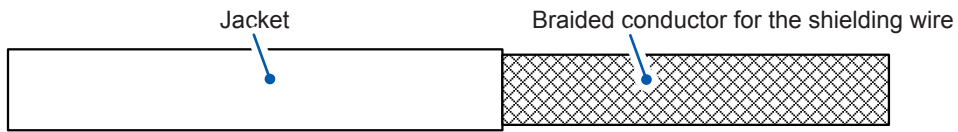

- 2 Turn the braided conductor for the shielding wire inside out.

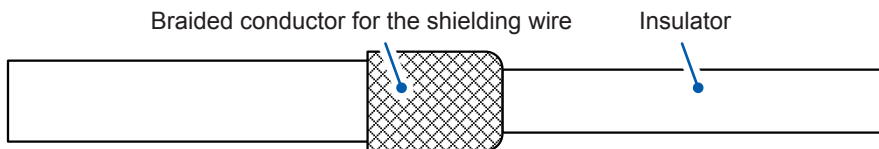

- 3 Strip off the insulator with a knife, etc.

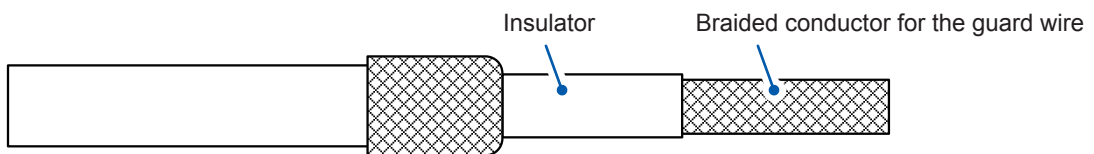

- 4 Turn the braided conductor for the guard wire inside out.

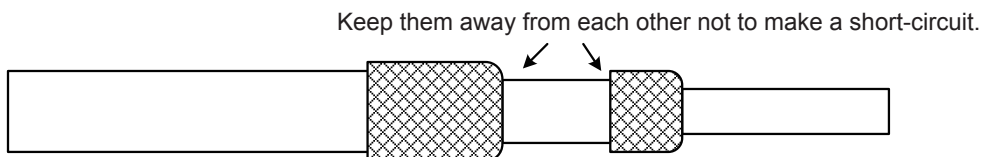

Take care not to short-circuit the shielding wire and the guard wire with each other.

5 Strip off the insulator with a knife, etc.

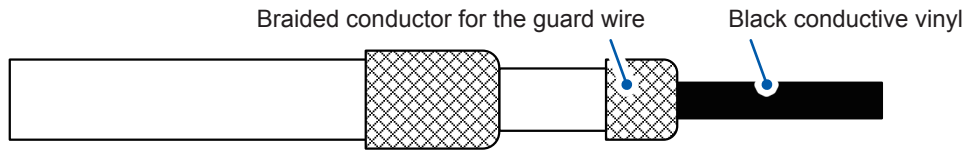

6 Completely remove the conducting vinyl.

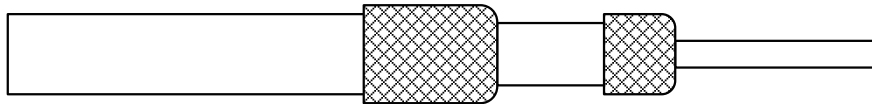

7 Strip off the insulator with a knife, etc.

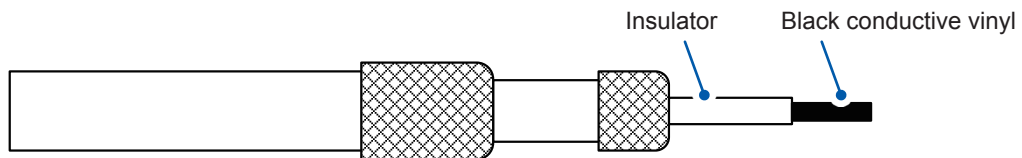

8 Completely remove the conducting vinyl.

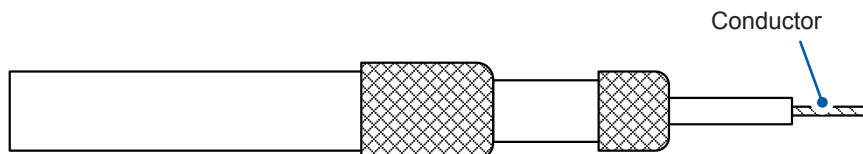

9 Cover the guard wire with a heat shrinkable tube and make it shrink.

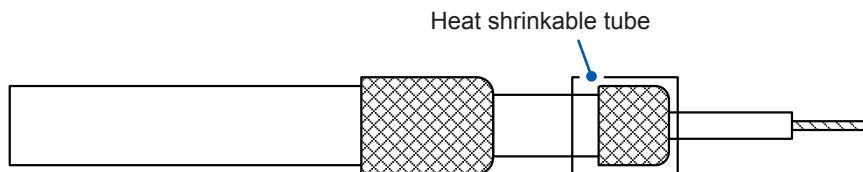

10 Cover the shielding wire with a heat shrinkable tube and make it shrink.

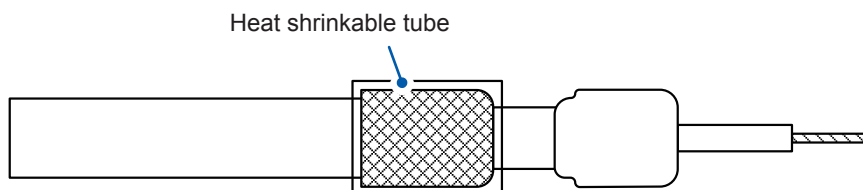

Completed

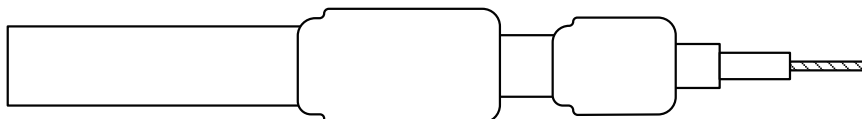

Appx. 7 Mounting Instrument in Rack

By using the internal threads on the sides, a rack mounting plate can be attached on the instrument.

! WARNING



To prevent instrument damage or an electric shock, use only the screws that originally secure the stands and the cover. (Stands: M3 × 6 mm, sides: M4 × 6 mm, when attaching a rack mounting plate: M4 × 10 mm)

If you lost any screws or find that any screws are damaged, please contact your Hioki distributor for a replacement.

Rack mounting plate (EIA)

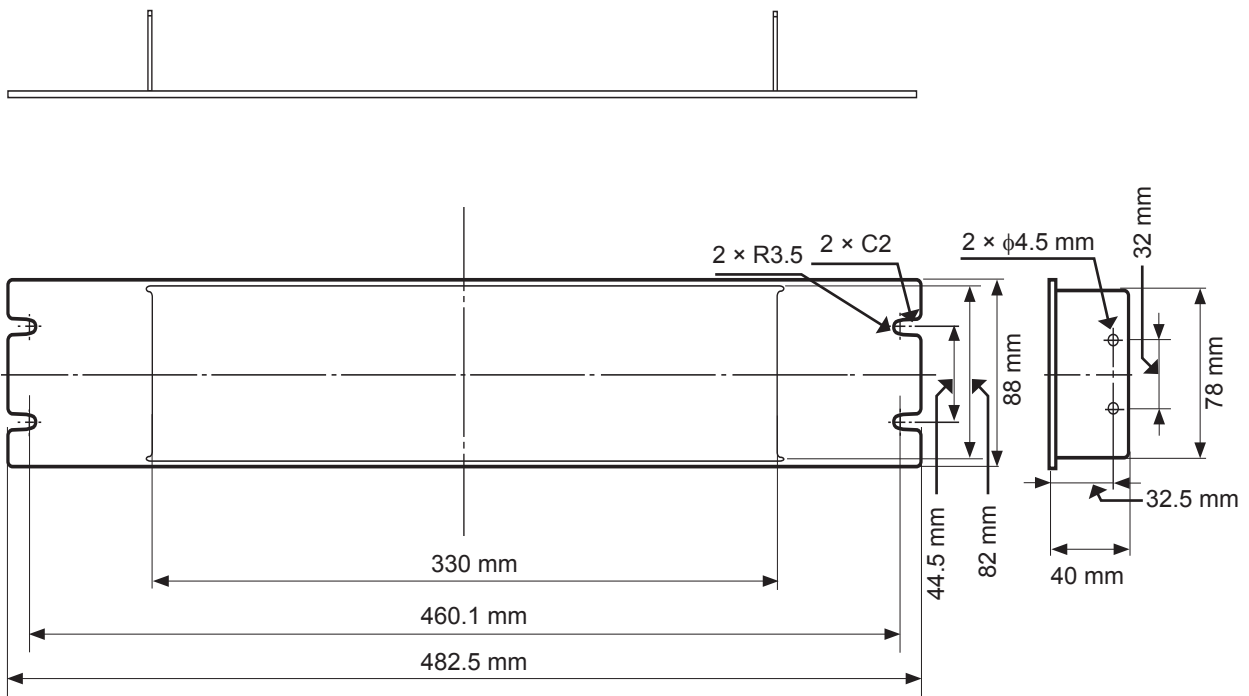

Rack mounting plate (JIS)

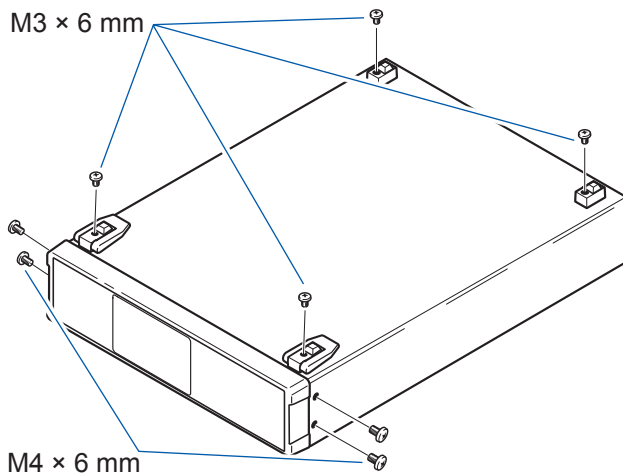
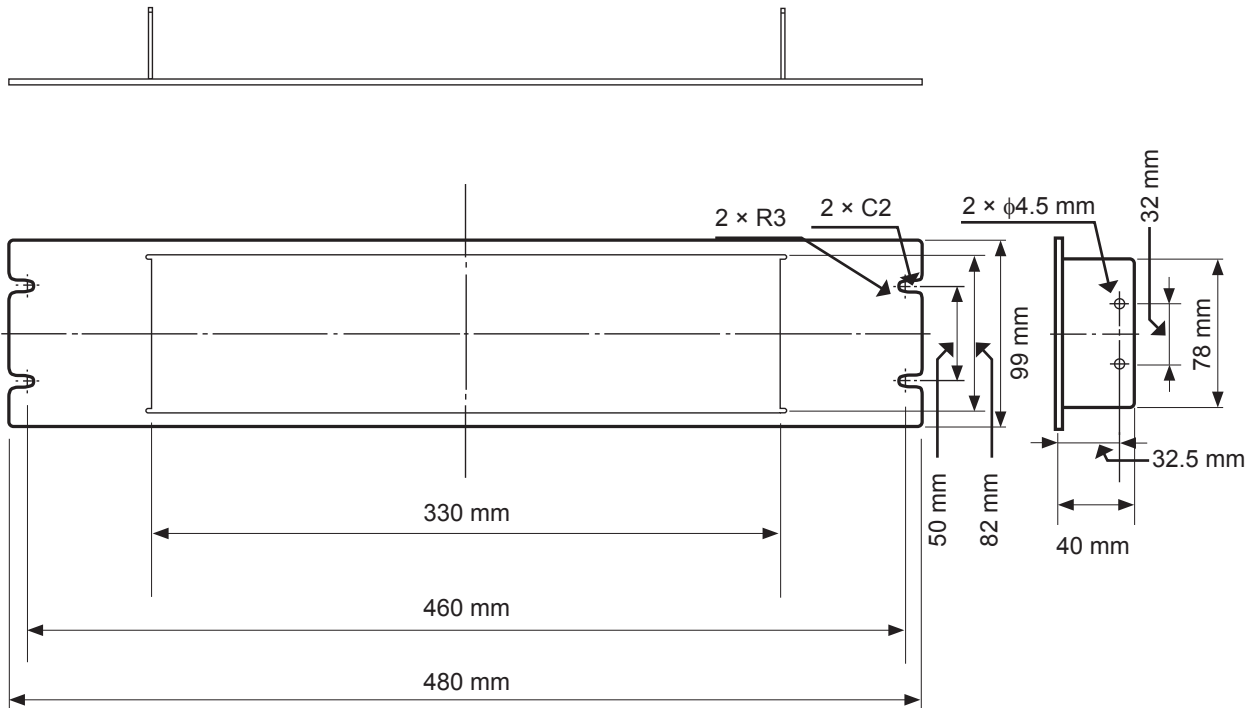

1 Remove the stands from the bottom of the instrument, and the screws from the sides (4 near the front).

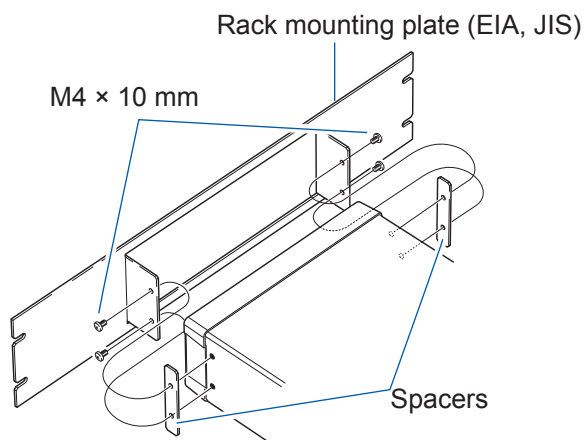

2 Install the spacers on both sides of the instrument, secure the rack mounting plate with the M4 x 10 screws.

- When installing the instrument into the rack, support the instrument with a commercially available support stand.
- Ensure that the vents on the sides are not blocked.

Appx. 8 Dimensional Diagram

Unit: mm

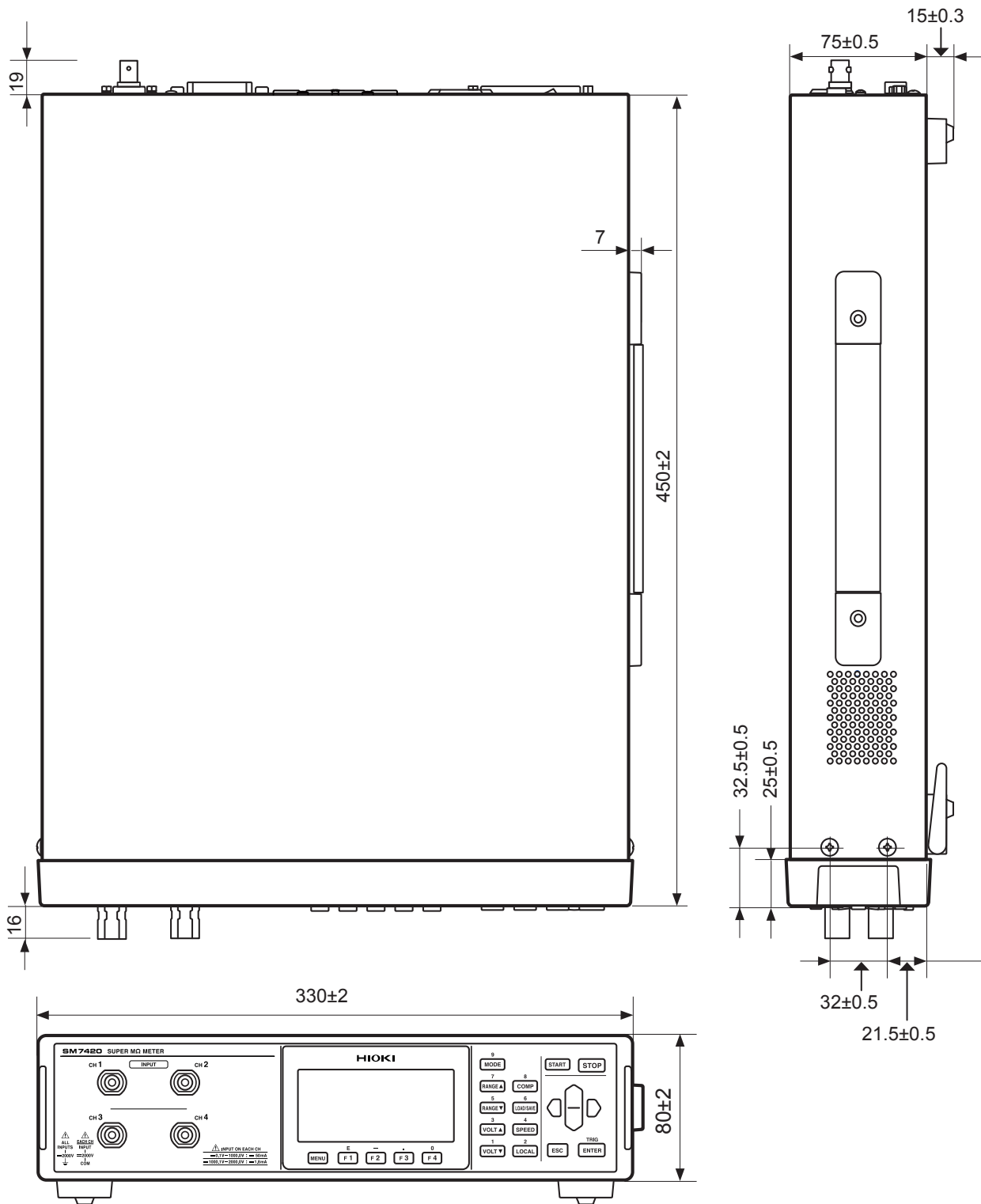

Unit: mm

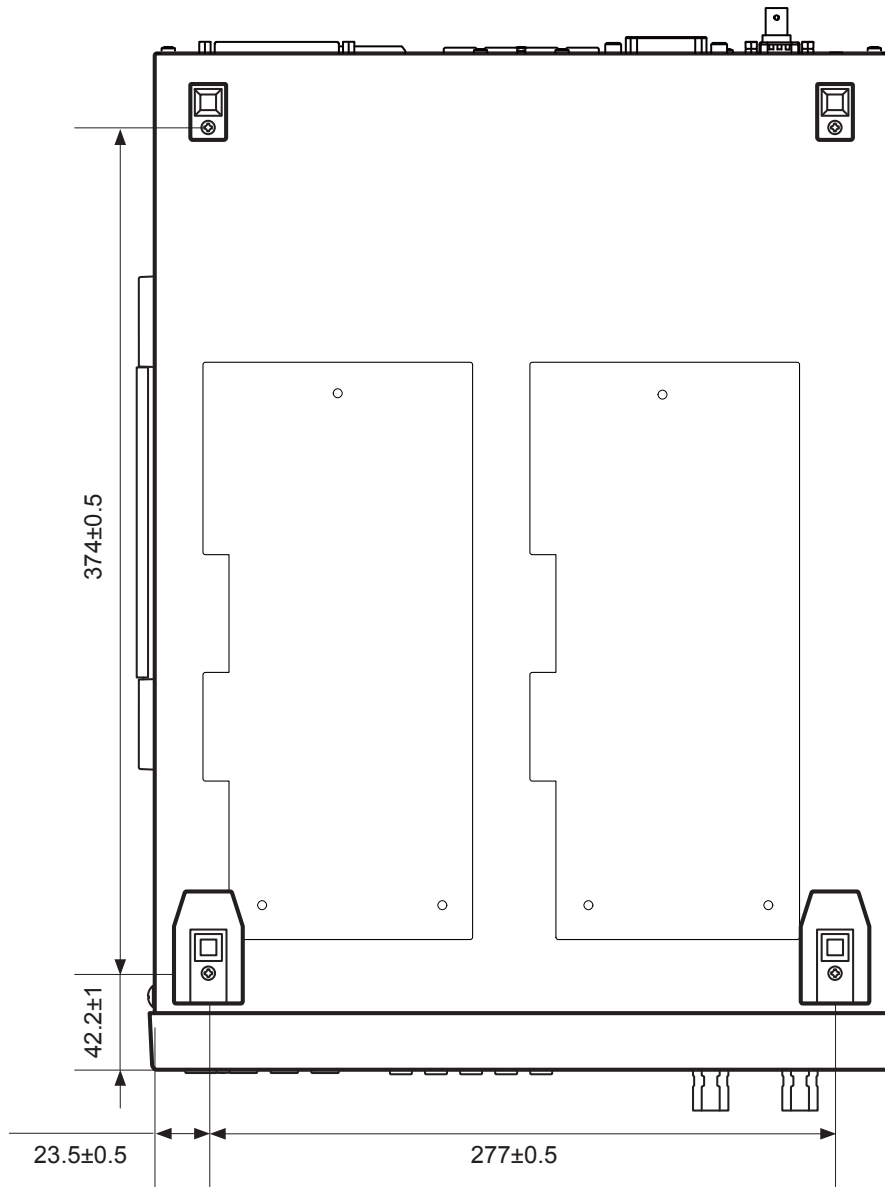

Index

A

Analog output	30, 83
Automatic measurement	62
Average function	44

B

Backlight	84
Block diagram	Appx.1

C

Calculation formula	127
Changing numerical values	25
Checking version numbers	88
Cleaning	138
Command	109, 118
Communication monitor function	117
Communications command	109
Comparator function	
Judgment result	72
Judgment sound	71
Connecting	
Humidity sensor	29
Measurement leads (to the instrument)	28
Measurement leads (to the object to be measured)	38
Measuring current	68
Power cord	27
Connecting	
Object to be measured, switching unit	Appx.7
Contact check function	53
Countermeasures against noise	Appx.3
Current range	36, 37
Current sink (NPN)	90
Current source (PNP)	90

D

D/A output	30, 83
Data output function	116
Delay function	43
Dimensional diagram	Appx.16
Display digit	34
Display format	34
Displaying communication commands	117

E

EOM signal output mode	107
Error display and solution	136
External control	89
EXT I/O	89
EXT I/O NPN/PNP switch	17
EXT I/O terminal	17
EXT I/O test functions	103

F

Fixture capacitance open correction function	52
Flat sample	63

G

GP-IB connector	17
GP-IB interface	114
Guard	60, 64, 65

H

High-speed measurement	58
Humidity Sensor	29

I

Initialization	86
Initial setting table	87
Input signal	93
Inspection before use	32
Installation	9
Internal circuit configuration	98
Electrical specifications	99
Examples of connection	100
Internal circuits	Appx.1
Internal memory data	81

J

Judgment results	72
Judgment sound	71

K

Key lock	80
Key operating sound	
Off	79
On	79
Key operation sound	79

L

Liquid sample	66
---------------------	----

M

Male connector for EXT I/O	102
Measured value display mode	33
Measured value judging function	69
Measurement abnormality detection	39
Measurement example	40
Measurement screen	21
Measurement speed	36

Measurement starting conditions.....	46
Measurement terminals.....	16
Measuring current.....	68
Memory function.....	81
Methods for changing numerical values.....	25
Modifying measurement lead.....	Appx.11

N

NPN/PNP.....	90
--------------	----

O

Operation keys.....	16, 19
Option.....	4
Out-of-range indication.....	39
Output signal.....	93
Outputting measured values.....	116

P

Panel loading function.....	75
Panel saving function.....	74
Power	
Power-off.....	31
Power-on.....	31
Power cord.....	27
Power supply frequency setting function.....	85
Power switch.....	17

Q

Q&A.....	133
----------	-----

R

Rack mounting.....	Appx.14
Remote state	
RMT.....	118
Replacement parts.....	138
Reset.....	86
Resistivity calculating function.....	55
RMT.....	118
RS-232C connector.....	17
RS-232C interface.....	112

S

Screen.....	21
Screen configuration.....	21, 23
Screen contrast.....	84
Self-calibration function.....	47
Setting	
Measurement speed.....	36
Voltage value for resistance calculation.....	35

Setting conditions	
Changing the panel name.....	76
Deleting.....	77
Loading.....	75
Saving.....	74
Settings screen.....	22
Shielding box.....	67
SM Sample Application Manual.....	138
Specifications.....	119
Stand.....	18
Surface resistivity.....	55
Switching unit.....	Appx.7
System test.....	88

T

Timing chart.....	94
Trigger filter.....	105
Trigger function.....	46
Inputting external trigger.....	46
Setting trigger.....	46
Trigger logic.....	104
Troubleshooting.....	133

U

USB connector.....	17
USB interface.....	110
Using external power supply.....	Appx.6

V

Voltage value for resistance value calculation.....	35
Volume resistivity.....	55

Warranty Certificate

HIOKI

Model	Serial number	Warranty period Three (3) years from date of purchase (___ / ___)
-------	---------------	--

Customer name: _____
Customer address: _____

Important

- Please retain this warranty certificate. Duplicates cannot be reissued.
- Complete the certificate with the model number, serial number, and date of purchase, along with your name and address. The personal information you provide on this form will only be used to provide repair service and information about Hioki products and services.

This document certifies that the product has been inspected and verified to conform to Hioki's standards. Please contact the place of purchase in the event of a malfunction and provide this document, in which case Hioki will repair or replace the product subject to the warranty terms described below.

Warranty terms

1. The product is guaranteed to operate properly during the warranty period (three [3] years from the date of purchase).
If the date of purchase is unknown, the warranty period is defined as three (3) years from the date (month and year) of manufacture (as indicated by the first four digits of the serial number in YYMM format).
2. If the product came with an AC adapter, the adapter is warranted for one (1) year from the date of purchase.
3. The accuracy of measured values and other data generated by the product is guaranteed as described in the product specifications.
4. In the event that the product or AC adapter malfunctions during its respective warranty period due to a defect of workmanship or materials, Hioki will repair or replace the product or AC adapter free of charge.
5. The following malfunctions and issues are not covered by the warranty and as such are not subject to free repair or replacement:
 - 1. Malfunctions or damage of consumables, parts with a defined service life, etc.
 - 2. Malfunctions or damage of connectors, cables, etc.
 - 3. Malfunctions or damage caused by shipment, dropping, relocation, etc., after purchase of the product
 - 4. Malfunctions or damage caused by inappropriate handling that violates information found in the instruction manual or on precautionary labeling on the product itself
 - 5. Malfunctions or damage caused by a failure to perform maintenance or inspections as required by law or recommended in the instruction manual
 - 6. Malfunctions or damage caused by fire, storms or flooding, earthquakes, lightning, power anomalies (involving voltage, frequency, etc.), war or unrest, contamination with radiation, or other acts of God
 - 7. Damage that is limited to the product's appearance (cosmetic blemishes, deformation of enclosure shape, fading of color, etc.)
 - 8. Other malfunctions or damage for which Hioki is not responsible
6. The warranty will be considered invalidated in the following circumstances, in which case Hioki will be unable to perform service such as repair or calibration:
 - 1. If the product has been repaired or modified by a company, entity, or individual other than Hioki
 - 2. If the product has been embedded in another piece of equipment for use in a special application (aerospace, nuclear power, medical use, vehicle control, etc.) without Hioki's having received prior notice
7. If you experience a loss caused by use of the product and Hioki determines that it is responsible for the underlying issue, Hioki will provide compensation in an amount not to exceed the purchase price, with the following exceptions:
 - 1. Secondary damage arising from damage to a measured device or component that was caused by use of the product
 - 2. Damage arising from measurement results provided by the product
 - 3. Damage to a device other than the product that was sustained when connecting the device to the product (including via network connections)
8. Hioki reserves the right to decline to perform repair, calibration, or other service for products for which a certain amount of time has passed since their manufacture, products whose parts have been discontinued, and products that cannot be repaired due to unforeseen circumstances.

HIOKI E.E. CORPORATION

<http://www.hioki.com>

18-07 EN-3

HIOKI

<http://www.hioki.com>



**All regional
contact
information**

HEADQUARTERS

81 Koizumi
Ueda, Nagano 386-1192 Japan

HIOKI EUROPE GmbH

Rudolf-Diesel-Strasse 5
65760 Eschborn, Germany
hioki@hioki.eu

1906 EN

Edited and published by HIOKI E.E. CORPORATION

Printed in Japan

- CE declarations of conformity can be downloaded from our website.
- Contents subject to change without notice.
- This document contains copyrighted content.
- It is prohibited to copy, reproduce, or modify the content of this document without permission.
- Company names, product names, etc. mentioned in this document are trademarks or registered trademarks of their respective companies.