

RIGOL



RSA5000 Series Real-time Spectrum Analyzer

- Ultra-Real technology
- Frequency: up to 6.5 GHz
- Displayed average noise level (DANL): < -165 dBm (typical)
- Phase noise: < -108 dBc/Hz (typical)
- Level measurement uncertainty: < 0.8 dB
- 6.5 GHz tracking generator
- Min. RBW 1 Hz
- Up to 40 MHz real-time analysis bandwidth
- Multiple measurement modes
- Various advanced measurement functions
- Vector signal analysis measurement application (option)
- EMI measurement application (option)
- Vector network analyzer application
- Multiple trigger modes and trigger masks
- Density, spectrogram, and other display modes
- PC software options
- 10.1" capacitive multi-touch screen, supporting touch gestures
- USB, LAN, HDMI and other communication and display interfaces

RSA5000 Series Real-time Spectrum Analyzer

Built-in Linux operating system reliable and stable interface



Product Dimensions: Width × Height × Depth = 410 mm × 224 mm × 135 mm

UltraReal

Based on the Ultra-Real technology, the high-speed real-time measurement mode allows you to acquire the signals in the analysis bandwidth seamlessly and make data analysis. It also provides various display modes, such as Spectrogram, Density, and PVT. Besides, FMT function is also available.

The Ultra-Real technology has the following features:

- Seamless analysis
- Seamless I/Q data acquisition in the analysis bandwidth
- Gap-free spectrum analysis

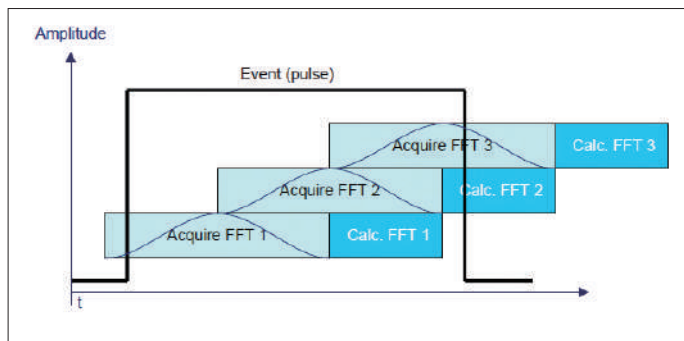

FMT

Frequency mask trigger (FMT) to trigger the measurement by sporadic or transient events in the spectrum

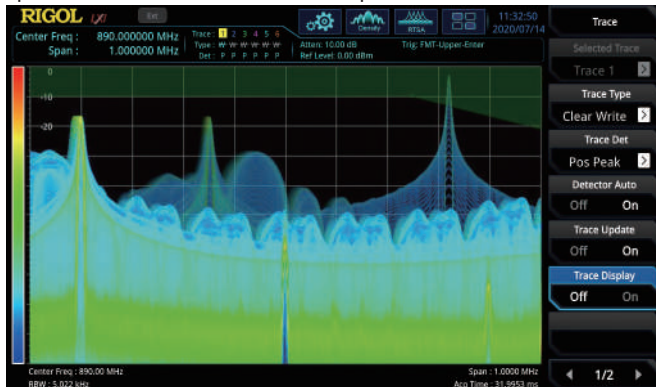

Composite displays

Spectrogram for gap-free display of the spectrum

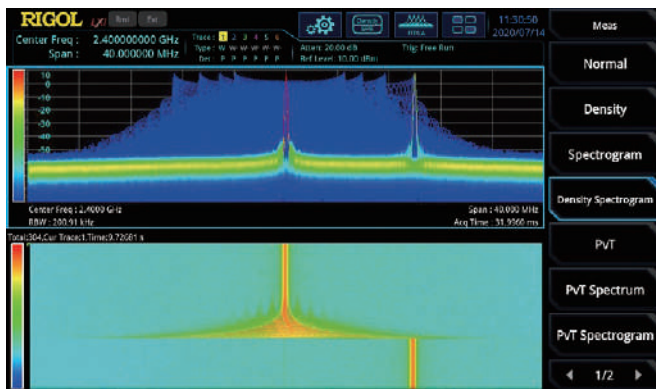

Density spectrum for you to visualize how frequently signals occur

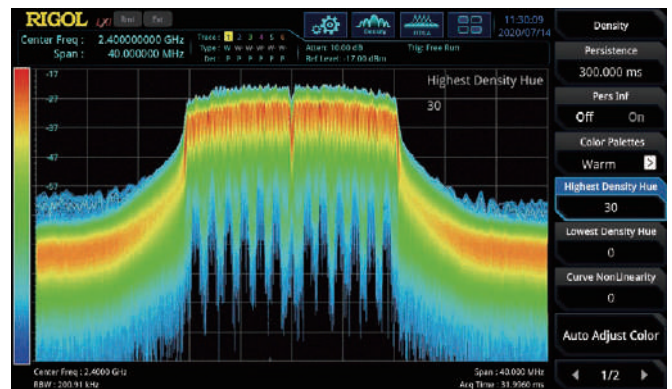

► RSA5000 Series Real-Time Spectrum Analyzer

- Integrates five measurement modes to address the challenges for multiple RF test requirements with one single instrument

RSA5000 series provides EMI, RTSA, VSA, and VNA modes in addition to the traditional GPSA mode. Engineers may find it convenient to address multiple RF test challenges with just one instrument, effectively reducing their time and costs, greatly improving their working efficiency.



Advanced measurement mode provides test items required for the transmitter test such as multichannel power, ACP, and occupied BW.



Quickly recall the limit line compliant with the CISPR standard (e.g. EN55011, EN55012, etc.) to carry out pre-test and monitor the target point with three different detectors.

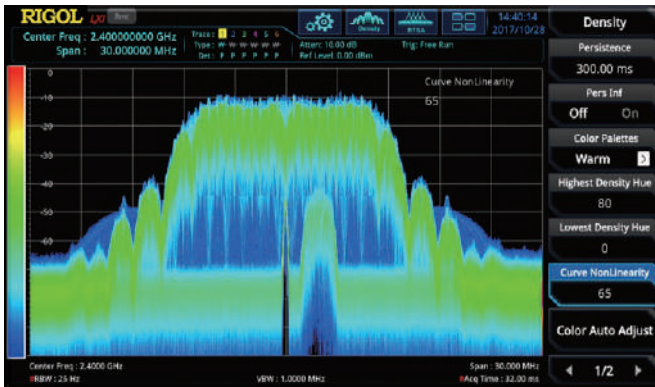

With the Density spectrum, you can find out the exceptional signals hidden behind the high-level signals, and capture them accurately with the FMT.

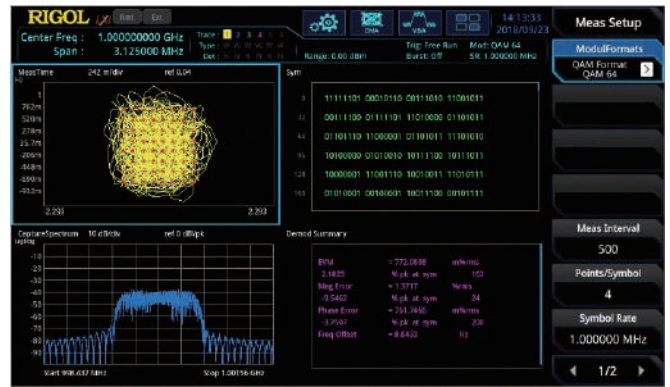

You can freely set the way to display the measurement results, demonstrate multiple views of the signals at one time to obtain a clearer display effect through flexible adjustment of the display layout.

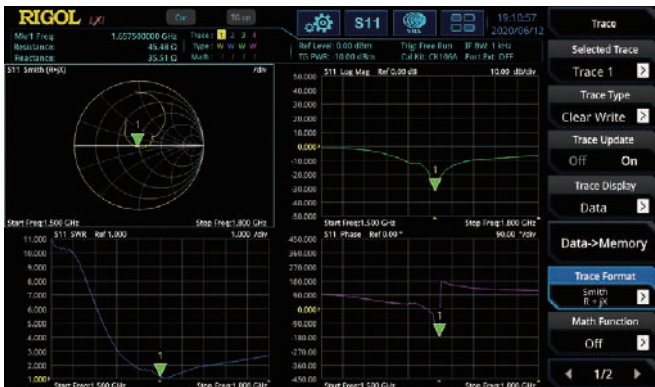

In VNA mode, you can make S11, S21, and DTF measurements for the components and circuit networks. The network characteristics of the components under test can be accurately demonstrated in Smith chart, Polar chart, and other formats.

■ Various operation modes to improve your operation experience

The 10.1-inch capacitive multi-touch screen supports various touch gestures, making it always keep up with the mainstream development trend for screen operation. The gesture-enabled operation such as tapping, dragging, pinching & stretching makes the measurement action smooth and convenient, easy for you to operate the instrument. Meanwhile, the instrument still keeps the knob and key operation as what RIGOL traditional instruments have, optimizing the user-friendly interactive experience to a large extent. It also supports keyboard and mouse operation.



■ Multiple interfaces to improve the connectivity of the instruments

The instrument can be connected to a larger display/monitor via the HDMI interface for better display effects. The Web Control function allows you to directly control the device by accessing the device IP address, improving the experience of remote control.



► Specifications

Specifications are valid under the following conditions: the instrument is within the calibration period, is stored for at least two hours at 0°C to 50°C temperature, and is warmed up for 40 minutes. Unless otherwise noted, the specifications in this manual include the measurement uncertainty.

Typical: characteristic performance, which 80 percent of the measurement results will meet at room temperature (approximately 25°C). This data is not warranted and does not include the measurement uncertainty.

Nominal: the expected mean or average performance or a designed attribute (such as the 50 Ω connector). This data is not warranted and is measured at room temperature (approximately 25°C).

Measured: an attribute measured during the design phase which can be compared to the expected performance, such as the amplitude drift variation with time. This data is not warranted and is measured at room temperature (approximately 25°C).

NOTE: All charts in this manual are the measurement results of multiple instruments at room temperature unless otherwise noted. The specifications (except the tracking generator specifications) listed in this manual are those when the tracking generator is off.

Measurement Mode

Measurement Mode

General-Purpose Spectrum Analyzer (GPSA)

Real-time Spectrum Analyzer (RTSA)

Vector Signal Analysis Measurement Application (VSA)

EMI Measurement Application (EMI)

Vector Network Analyzer Application (VNA)

Measurement Mode and Product Model Adaptation Table

	RSA5032	RSA5032-TG	RSA5032N	RSA5065	RSA5065-TG	RSA5065N
GPSA	√	√	√	√	√	√
RTSA	√	√	√	√	√	√
VSA	O	O	O	O	O	O
EMI	O	O	O	O	O	O
VNA	x	x	√	x	x	√
Tracking Generator	x	√	√	x	√	√

Note: x indicates not supported; √ indicates standard configuration; O indicates optional configuration.

The RSA5000N models include hardware capability not in the RSA5000-TG. The RSA5000-TG models cannot be used in VNA mode.

All Measurement Modes

Frequency

	RSA5032/-TG/N	RSA5065/-TG/N
Frequency Range	9 kHz to 3.2 GHz	9 kHz to 6.5 GHz
Internal Reference Frequency	10 MHz	
Reference Frequency	10 MHz	
Accuracy	± [(time since last calibration × aging rate) + temperature stability + calibration accuracy]	
Initial Calibration Accuracy	Standard	<1 ppm
	Option OCXO-C08	<0.1 ppm
Temperature Stability	0°C to 50°C, with the reference 25°C	
	Standard	<0.5 ppm
	Option OCXO-C08	<0.005 ppm
Aging Rate	Standard	<1 ppm/year
	Option OCXO-C08	<0.03 ppm/year

GPSA Mode

Frequency

Frequency Readout Accuracy		
Marker Frequency Resolution	span/(number of sweep points - 1)	
Marker Frequency Uncertainty	\pm (marker frequency readout \times reference frequency accuracy + 1% \times span + 10% \times resolution bandwidth + marker frequency resolution)	
Frequency Counter		
Resolution	1 Hz	
Uncertainty	\pm (marker frequency readout \times reference frequency accuracy + counter resolution)	
Frequency Span		
Range	0 Hz, 10 Hz to maximum frequency	
Resolution	2 Hz	
Uncertainty	\pm span/(number of sweep points - 1)	
SSB Phase Noise		
20°C to 30°C, $f_c = 500$ MHz		
Carrier Offset	1 kHz	<-95 dBc/Hz (typical)
	10 kHz	<-106 dBc/Hz, <-108 dBc/Hz (typical)
	100 kHz	<-106 dBc/Hz, <-108 dBc/Hz (typical)
	1 MHz	<-115 dBc/Hz, <-117 dBc/Hz (typical)

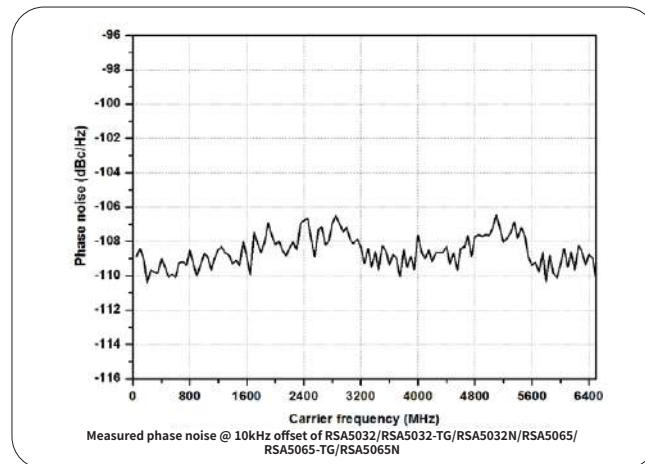

Residual FM	
	20°C to 30°C, RBW = VBW = 1 kHz
Residual FM	<10 Hz (nominal)
Bandwidth	
	Set "Sweep Time Rule" to "Accy"
Resolution Bandwidth (-3 dB) ^[1]	1 Hz to 10 MHz, in 1-3-10 sequence
RBW Accuracy	3 kHz to 10 MHz, <5% (nominal)
	10 Hz to 1 kHz, <15% (nominal)
Resolution Filter Shape Factor (60 dB: 3 dB)	<5 (nominal)
Video Bandwidth (-3 dB)	1 Hz to 10 MHz, in 1-3-10 sequence
Resolution Bandwidth (-6 dB)	200 Hz, 9 kHz, 120 kHz, 1 MHz

Note: [1] When the tracking generator is enabled or in zero span mode, the available range of RBW is from 1 kHz to 10 MHz.

Amplitude

Measurement Range	
Range	$f_c \geq 10$ MHz DANL to +30 dBm
Maximum Safe Input Level ^[1]	
DC Voltage	50 V
CW RF Power	+30 dBm, attenuation ≥ 40 dB, preamp off. -10 dBm, attenuation = 20 dB, preamp on.
Maximum Damage Level	
CW RF Power	+33 dBm (2 W)

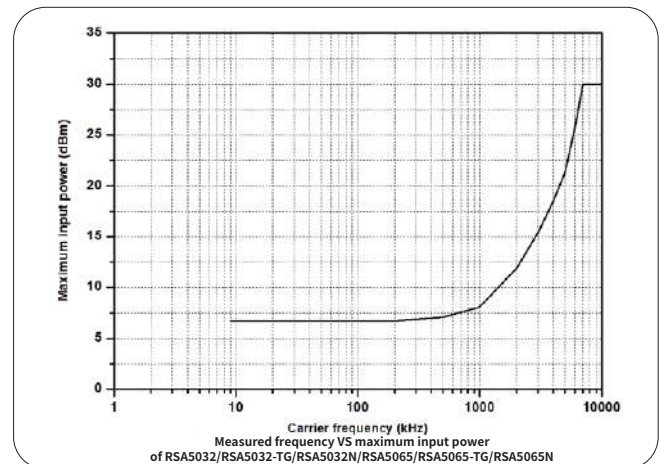
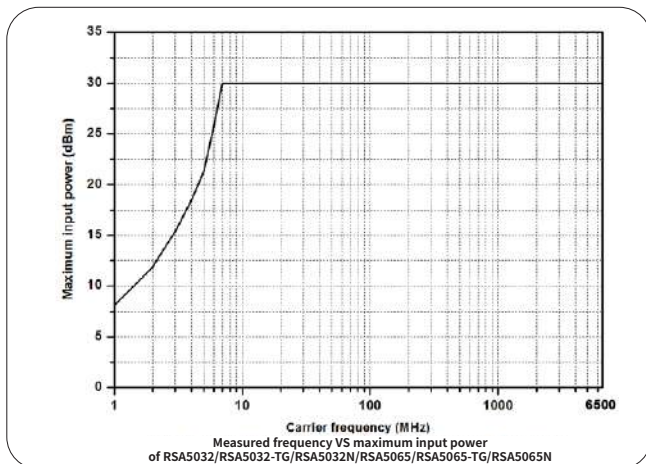

Displayed Average Noise Level (DANL)			
		RSA5032/-TG/N	RSA5065/-TG/N
		attenuation = 0 dB, sample detector, trace averages ≥ 50 , tracking generator off, normalized to 1 Hz, 20°C to 30°C, input impedance = 50 Ω .	
Preamp off	9 kHz to 100 kHz	<-120 dBm (typical)	<-120 dBm (typical)
	100 kHz to 20 MHz	<-135 dBm, <-140 dBm (typical)	<-135 dBm, <-140 dBm (typical)
	20 MHz to 1.5 GHz	<-142 dBm, <-145 dBm (typical)	<-142 dBm, <-145 dBm (typical)
	1.5 GHz to 2.7 GHz	<-140 dBm, <-143 dBm (typical)	<-140 dBm, <-143 dBm (typical)
	2.7 GHz to 3.2 GHz	<-138 dBm, <-141 dBm (typical)	<-138 dBm, <-141 dBm (typical)
	3.2 GHz to 5.5 GHz		<-138 dBm, <-143 dBm (typical)
	5.5 GHz to 6.5 GHz		<-136 dBm, <-141 dBm (typical)
Preamp on	100 kHz to 20 MHz	<-152 dBm, <-160 dBm (typical)	<-152 dBm, <-160 dBm (typical)
	20 MHz to 1.5 GHz	<-162 dBm, <-165 dBm (typical)	<-162 dBm, <-165 dBm (typical)
	1.5 GHz to 2.7 GHz	<-160 dBm, <-163 dBm (typical)	<-160 dBm, <-163 dBm (typical)
	2.7 GHz to 3.2 GHz	<-158 dBm, <-161 dBm (typical)	<-158 dBm, <-161 dBm (typical)
	3.2 GHz to 5.5 GHz		<-156 dBm, <-161 dBm (typical)
	5.5 GHz to 6.5 GHz		<-154 dBm, <-159 dBm (typical)

Note: [1] When $f_c < 10$ MHz, the maximum safe input level is decreased.

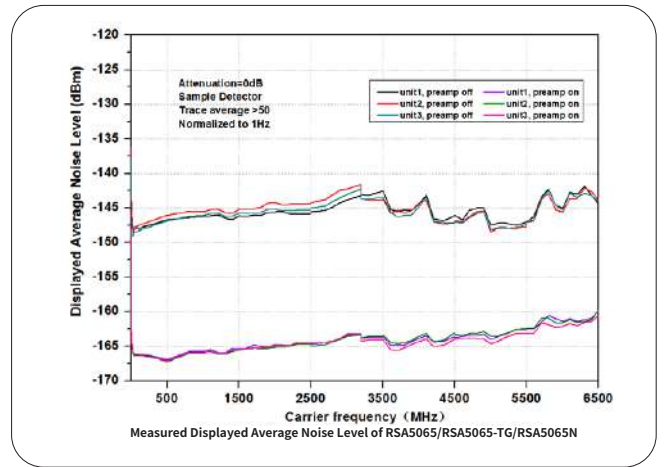
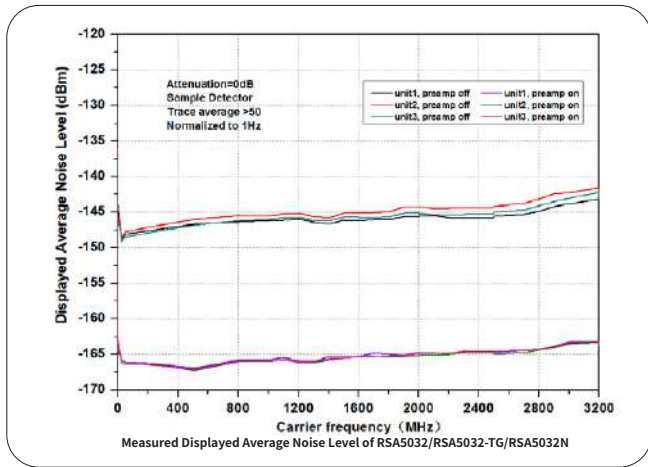

Level Display

Logarithmic Scale	1 dB to 200 dB
Linear Scale	0 to reference level
Number of Display Points	801
Number of Traces	6
Trace Detector	normal, pos-peak, neg-peak, sample, RMS average, voltage average, and quasi-peak
Trace Function	clear write, max hold, min hold, average, view, blank
Scale Unit	dBm, dBmV, dBμV, nV, μV, mV, V, nW, μW, mW, W

Frequency Response

		RSA5032/-TG/N	RSA5065/-TG/N
attenuation = 10 dB, relative to 50 MHz, 20°C to 30°C			
Preamp off	100 kHz to 3.2 GHz	<0.5 dB, <0.3 dB (typical)	<0.5 dB, <0.3 dB (typical)
	3.2 GHz to 6.5 GHz		<0.7 dB, <0.5 dB (typical)
attenuation = 0 dB, relative to 50 MHz, 20°C to 30°C			
Preamp on	100 kHz to 3.2 GHz	<0.7 dB, <0.3 dB (typical)	<0.7 dB, <0.3 dB (typical)
	3.2 GHz to 6.5 GHz		<0.9 dB, <0.5 dB (typical)

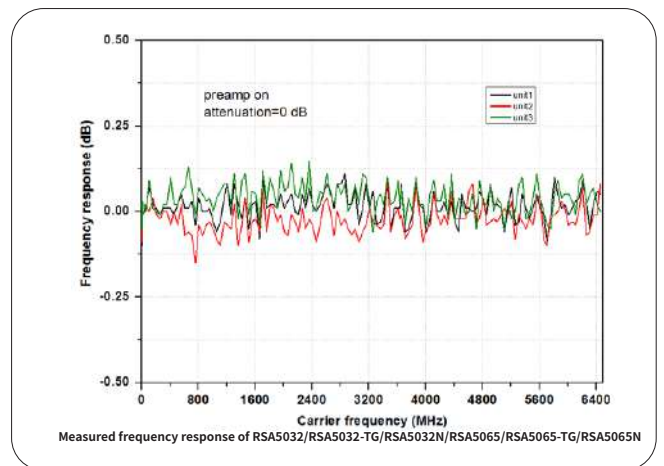
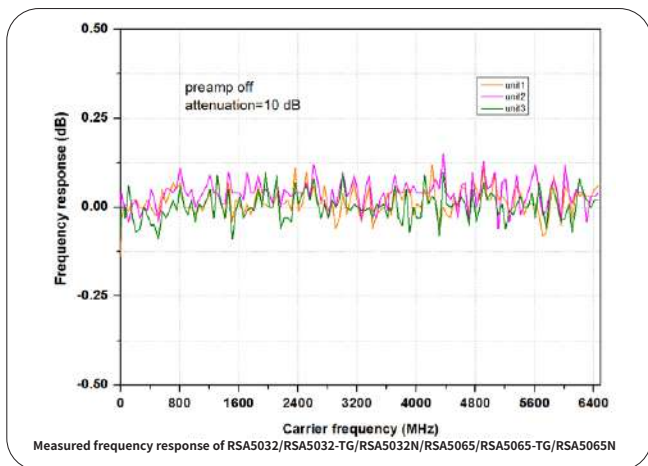

Input Attenuation Switching Uncertainty

Setting Range	0 dB to 50 dB, in 1 dB step
Switching Uncertainty	$f_c = 50$ MHz, relative to 10 dB, preamp off, 20°C to 30°C <0.3 dB

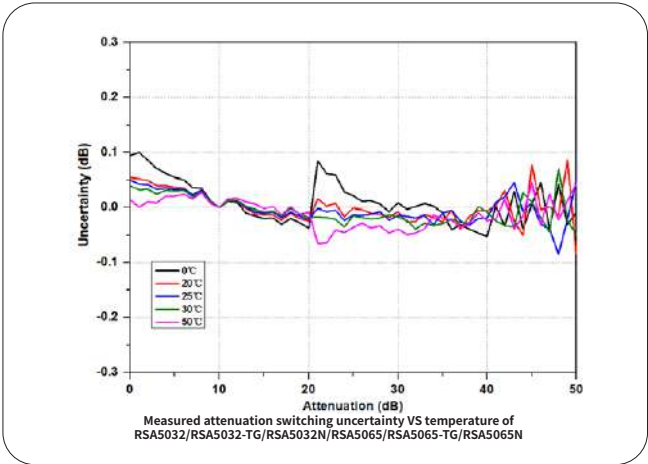
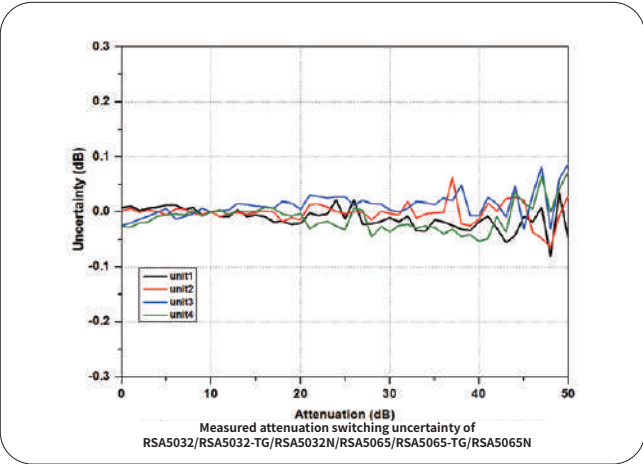

Absolute Amplitude Accuracy

Uncertainty	$f_c = 50$ MHz, peak detector, preamp off, attenuation = 10 dB, input signal level = -10 dBm, 20°C to 30°C <0.3 dB
-------------	---

Reference Level

Range	Logarithmic Scale	-170 dBm to +30 dBm, in 0.01 dB step
	Linear Scale	707 pV to 7.07 V, 0.11% (0.01 dB) resolution

RBW Switching

	Set "Sweep Time Rule" to "Accy", relative to 30 kHz RBW	
Uncertainty	1 Hz to 1 MHz	<0.1 dB
	3 MHz, 10 MHz	<0.3 dB

Preamp (Option RSA5000-PA)

	RSA5032/-TG/N	RSA5065/-TG/N
Frequency Range	100 kHz to 3.2 GHz	100 kHz to 6.5 GHz
Gain	20 dB (nominal)	

Level Measurement Uncertainty

	95% confidence level, S/N > 20 dB, RBW = VBW = 1 kHz, preamp off, attenuation = 10 dB, -50 dBm < input level ≤ 0 dBm, $f_c > 10$ MHz, 20°C to 30°C
Level Measurement Uncertainty	<0.8 dB (nominal)

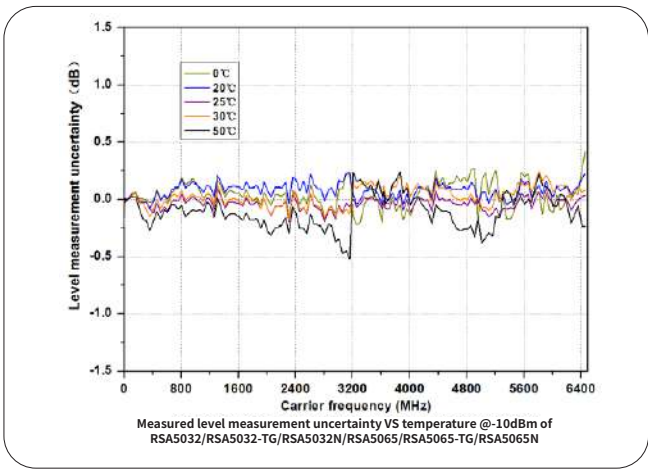

RF Input VSWR

		RSA5032/-TG/N	RSA5065/-TG/N
		attenuation ≥ 10 dB, preamp off	
VSWR	300 kHz to 3.2 GHz	<1.6 (nominal)	<1.6 (nominal)
	3.2 GHz to 6.5 GHz		<1.8 (nominal)

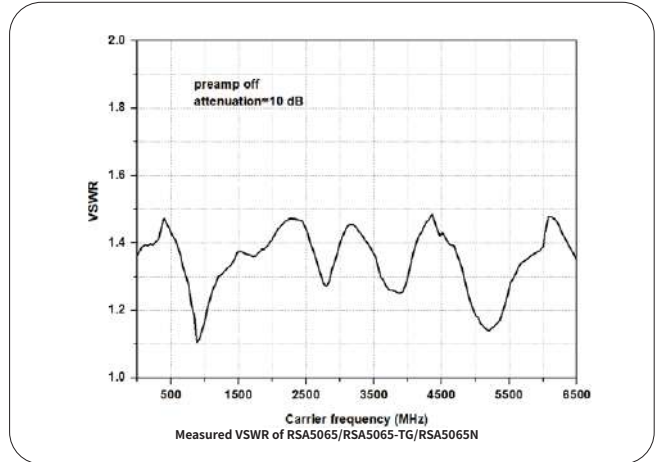
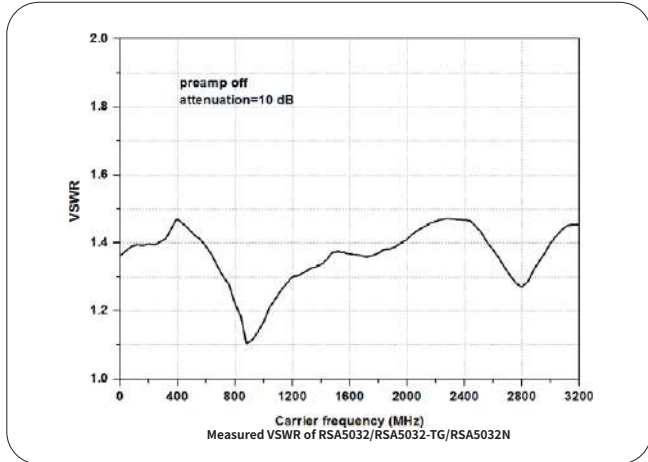

Distortion

Second Harmonic Intercept (SHI)	$f_c \geq 50$ MHz, input signal level = -20 dBm, attenuation = 0 dB, preamp off. +45 dBm
Third-order Intercept (TOI)	$f_c \geq 50$ MHz, two -20 dBm tones at input mixer spaced by 200 kHz, attenuation = 0 dB, preamp off. +11 dBm, +15 dBm (typical)
1 dB Gain Compression (P1dB) ^[1]	$f_c \geq 50$ MHz, attenuation = 0 dB, preamp off. 0 dBm (nominal)

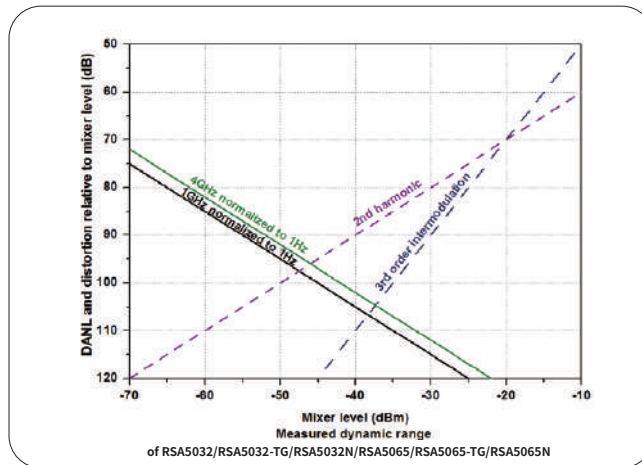

Spurious Response

Residual Response	input terminated with a 50 Ω load, attenuation = 0 dB, 20°C to 30°C <-90 dBm, <-100 dBm (typical)
Intermediate Frequency	<-60 dBc
System-related Sideband	referenced to local oscillators, referenced to A/D conversion, referenced to subharmonic of first LO, referenced to harmonic of first LO <-60 dBc
Input-related Spurious	mixer level = -30 dBm <-60 dBc

Note: [1] The frequency interval of the two-tone signals should be greater than 10 MHz.

Sweep

Sweep		
Sweep Time	span \geq 10 Hz	1 ms to 4,000 s
	zero span	1 μ s to 6,000 s
Sweep Time Uncertainty	span \geq 10 Hz, RBW \geq 1 kHz	5% (nominal)
	zero span (sweep time > 1 ms)	5% (nominal)
Sweep Mode	continue, single	

Trigger

Trigger		
Trigger Source	free run, external 1, external 2, video	
Trigger Delay	span \geq 10 Hz	0 to 500 ms
	zero span	0 to 500 ms

Tracking Generator

Tracking Generator Output		
	RSA5032-TG/N	RSA5065-TG/N
Frequency Range	100 kHz to 3.2 GHz	100 kHz to 6.5 GHz
Output Level Range	-40 dBm to 0 dBm	
Output Level Resolution	1 dB	
Output Flatness	relative to 50 MHz	
	\pm 3 dB (nominal)	

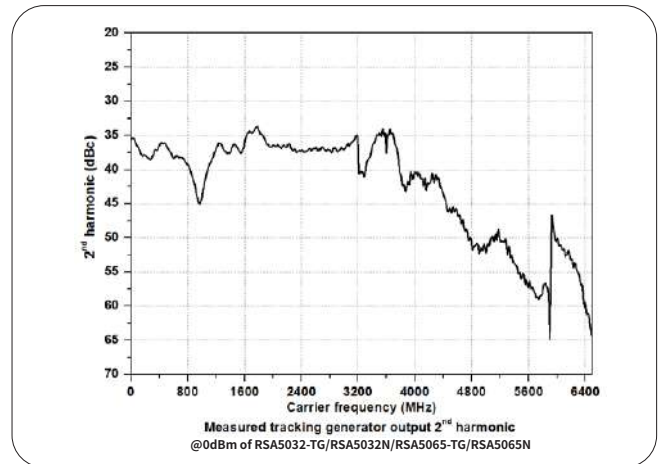
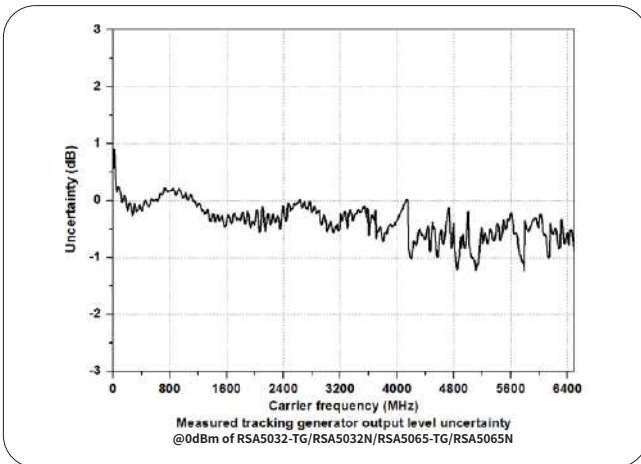

RTSA Mode

Real-time Analysis Bandwidth	25 MHz					
	40 MHz (Option RSA5000-B40)					
Min. Signal Duration for 100% POI at the Full-Scale Accuracy	maximum span, default Kaiser window					
	7.45 μ s					
Trace Detector	pos-peak, neg-peak, sample, average					
Number of Traces	6					
Window Type	Hanning, Blackman-Harris, Rectangular, Flattop, Kaiser, and Gaussian					
Resolution Bandwidth	provides 6 RBWs for each window, except the Rectangular; for Kaiser window					
	Span	Min. bandwidth		Max. bandwidth		
	40 MHz	100 kHz		3.21 MHz		
	25 MHz	62.8 kHz		2.01 MHz		
	10 MHz	25.1 kHz		804 kHz		
	1 MHz	2.51 kHz		80.4 kHz		
100 kHz	251 Hz		8.04 kHz			
Max. Sample Rate	51.2 MSa/s					
FFT Rate	146,484/s (nominal)					
Number of Markers	8					
Amplitude Resolution	0.01 dB					
Frequency Point	801					
Acquisition Time	Max. sample rate					
	>156.5 μ s					
Min. Signal Duration for 100% POI at Different RBWs						
	Duration Time (μ s)					
Span	RBW1	RBW2	RBW3	RBW4	RBW5	RBW6
40 MHz	26.9	16.9	11.9	9.32	8.07	7.45
25 MHz	38.9	22.9	14.9	10.9	8.82	7.82
10 MHz	86.8	46.8	26.8	16.8	11.8	9.30
1 MHz	807	407	207	107	56.3	31.3
Amplitude						
Amplitude Flatness	± 0.5 dB ^[1] (nominal)					
SFDR	<-60 dBc (typical)					
UltraReal Density						
Probability Range	0 to 100% (with a step of 0.1%)					
Min. Span	5 kHz					
Persistence Duration	32 ms to 10 s					
UltraReal Spectrogram						
History Depth	8,192					
Dynamic Range Covered by Bitmap Color	200 dB					
UltraReal PVT						
Min. Acquisition Time	187.9 μ s					
Max. Acquisition Time	40 s					
Trigger						
Trigger Source	free run, external 1, external 2, power (time), FMT					
UltraReal FMT						
Trigger Diagram	density, spectrogram, normal, PVT					
Trigger Resolution	0.5 dB (nominal)					
Trigger Criteria	enter, leave, inside, outside, enter-leave, leave-enter					

Note: [1] Only applicable to the Normal measurement.

VSA Mode (Option RSA5000-VSA)

Capture Oversampling		
Capture Oversampling	4, 8, 16	
Capture Length		
Capture Oversampling = 4	Maximum 4096	
Capture Oversampling = 8	Maximum 2048	
Capture Oversampling = 16	Maximum 1024	
Sample Rate		
Maximum Sample Rate	32 MHz 51.2 MHz (Option RSA5000-B40)	
Symbol Rate		
Symbol Rate	depends on capture oversampling = sample rate/capture oversampling, ≥ 1 kHz	
Usable I/Q Bandwidth		
Usable I/Q Bandwidth	symbol rate \times capture oversampling / 1.28	
Trigger Mode		
Trigger Mode	free run, external1, external2, power (time), FMT	
Modulation Format		
FSK	2FSK, 4FSK, 8FSK,	
MSK	including GMSK, can select differential coding or not	
PSK	BPSK, QPSK, OQPSK, DQPSK, $\pi/4$ -DQPSK, 8PSK, D8PSK, $\pi/8$ -D8PSK	
QAM	16QAM, 32QAM, 64QAM	
ASK	2ASK, 4ASK	
Filter Type		
Measurement Filter Type	No Filter, RRC, Gaussian, Rectangular, User Defined	
Reference Filter Type	Raised Cosine, RRC, Gaussian, Rectangular, Half Sine, User Defined	
Predefined standard		
Cellular	GSM, NADC, WCDMA, PDC, PHP (PHS)	
Wireless Networking	Bluetooth, WLAN (802.11b), ZigBee	
Others	TETRA, DECT, APCO-25	
Measurement Uncertainty		
	Specifications apply under the following conditions: temperature from +20 °C to +30 °C signal level ≥ -25 dBm properly adjusted reference level offset between device's center frequency and signal's center frequency smaller than 5 % of symbol rate Random data sequence Capture oversampling is set to 4.	
Residual Error for QPSK		
Test Signal	The reference filter is RRC with rolloff factor 0.22. The measurement filter is RRC with rolloff factor 0.22. The result length is 150 symbol. The center frequency is 1 GHz.	
	Residual EVM RMS	
Symbol Rate	100 kHz	< 1.5% (nominal)
	1 MHz	< 2% (nominal)
Residual Error for FSK		
Test Signal	The reference filter is RRC with rolloff factor 0.22. The measurement filter is RRC with rolloff factor 0.22. The FSK reference deviation is a quarter of the symbol rate. The result length is 150 symbols. The center frequency is 1 GHz.	
	Residual Frequency Error RMS	
Symbol Rate	100 kHz	< 2% (nominal)
	1 MHz	< 2.5% (nominal)

EMI Mode (Option RSA5000-EMI)

EMI Resolution Bandwidth		
Resolution Bandwidth (-3 dB)	100 Hz to 10 MHz, in 1-3-10 sequence	
Resolution Bandwidth (-6 dB)	200 Hz, 9 kHz, 120 kHz, 1 MHz	
EMI Detector		
Detector	pos-peak, neg-peak, average, quasi-peak, CISPR average, RMS average	

EMI Key Feature	
Key Feature	CISPR 16-1-1 detectors
	CISPR 16-1-1 bandwidths
	log and linear display
	signal table
	scan table
	simultaneous detectors
	automatic limit testing
	measure at marker
	delta to limit
	step and swept scans
report generation	

VNA Mode

Measurement Setup		
Frequency Range	RSA5032N 10 MHz~3.2 GHz	RSA5065N 10 MHz~6.5 GHz
Measurement Type	Reflection(S11), Transmission(S21), Distance-to-fault (DTF)	
Measurement Bandwidth	1 kHz~10 MHz (in 1-3-10 sequence)	
Data Points	101~10001; default 201	
Trace Type	mem, math, clear write, average, max hold, min hold,	
Number of Markers	8	
Mechanical Calibration Kit	Open, Short, Load, Through; User Calibration Kit	
Transmission Measurement S ₂₁		
Port Output Power	-10 dBm (nom.)	
Format	Lin Mag, Log Mag, Phase, Group Delay	
Magnitude Range	-500 G to 500 G	
Magnitude Resolution	Log: 100f; Lin 1a	
Dynamic Range	S21, RBW=10 kHz, Port1 level=0 dBm, Log Mag, Average=50 80 dB (nom.)	
Reflection Measurement S ₁₁		
Port Output Power	-10 dBm (nom.)	
Format	Lin Mag, Log Mag, Phase, Group Delay, SWR, Smith Chart (Lin/Phase, Log/Phase, Real/Imag, R+j*X, G+j*B), Polar Chart (Lin/Phase, Log/Phase, Real/Imag)	
Magnitude Range	-500 G to 500 G	
Magnitude Resolution	Log: 100f; Lin 1a	
VSWR Range	-500 G to 500 G	
Corrected Directivity (With CK106A)	S11, Log Mag, Average=50 > 40 dB (nom.)	

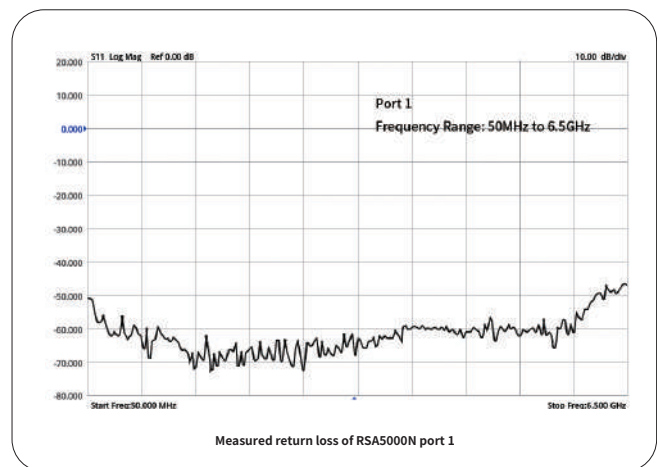
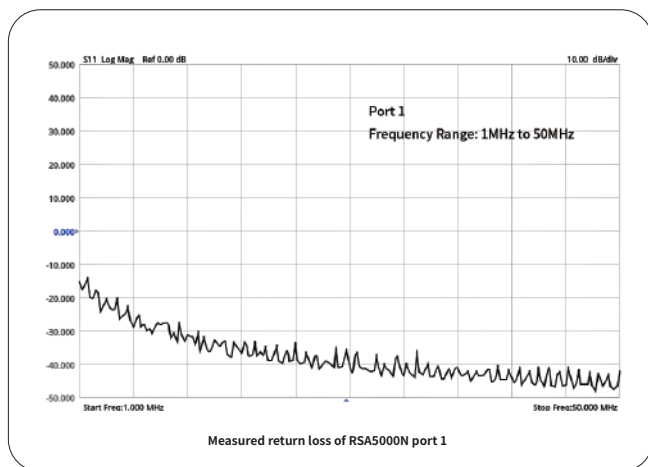

Distance to Fault (DTF)	
Port Output Power	0 dBm (nom.)
Format	Lin Mag, Log Mag, SWR
Maximum Distance (meters)	$8.0 \times 10^{10} \times \text{Velocity Factor/Span}$
Fault Resolution in meters	$1.5 \times 10^8 \times \text{Velocity Factor/Span}$
Windows	Gaussian, Flattop, Rectangular, Hanning, Hamming
Velocity Factor	0.1~1

General Specifications

Display		
Type	capacitive multi-touch screen	
Resolution	1024 × 600 pixels	
Size	10.1"	
Color	24-bit color	
Printer Supported		
Protocol	network printer	
Mass Memory		
Mass Memory	Internal Storage	512 MB (nominal)
	External Storage	USB storage device (not supplied)
Power		
Input Voltage Range, AC	100 V to 240 V (nominal)	
AC Frequency	45 Hz to 440 Hz	
Power Consumption	55 W (typical), max. 90 W with all options	
Environment		
Temperature	Operating Temperature Range	0°C to 50°C
	Storage Temperature Range	-20°C to 70°C
Humidity	0°C to 30°C	≤ 95% RH
	30°C to 40°C	≤ 75% RH
Altitude	Operating Height	below 3,048 m (10,000 feet)
Electromagnetic Compatibility and Safety		
EMC	complies with EMC Directive 2014/30/EU, complies with or above the standard specified in IEC61326-1:2013/EN61326-1:2013 Group 1 Class A	
	CISPR 11/EN 55011	
	IEC 61000-4-2:2008/EN 61000-4-2	±4.0 kV (contact discharge), ±8.0 kV (air discharge)
	IEC 61000-4-3:2002/EN 61000-4-3	3V/m (80 MHz to 1 GHz); 3V/m (1.4 GHz to 2 GHz); 1V/m (2.0 GHz to 2.7 GHz)
	IEC 61000-4-4:2004/EN 61000-4-4	1 kV power
	IEC 61000-4-5:2001/EN 61000-4-5	0.5 kV (phase-to-neutral voltage); 1 kV (phase-to-earth voltage); 1 kV (neutral-to-earth voltage)
	IEC 61000-4-6:2003/EN 61000-4-6	3 V, 0.15 to 80 MHz
Safety	IEC 61000-4-11:2004/EN 61000-4-11	
	voltage dip: 0% UT during half cycle; 0% UT during 1 cycle; 70% UT during 25 cycles short interruption: 0% UT during 250 cycles	
Safety	complies with IEC 61010-1:2010 (Third Edition)/EN 61010-1:2010, UL 61010-1:2012 R4.16 and CAN/CSA-C22.2 No. 61010-1-12+ G11+ G12	
Environmental Stress	Samples of this product have been type tested in accordance with RIGOL's reliability test regulations and verified to be robust against the environmental stresses of storage, transportation, and end-use; those stresses include, but are not limited to, temperature, humidity, shock, and vibration. The test methods are compliant with standards specified in GB/T6587 Class 2 and MILPRF-28800F Class 3.	

Size	
(W x H x D)	410 mm × 224 mm × 135 mm (16.14" × 8.82" × 5.32")
Weight	
Without Tracking Generator	4.65 kg (10.25 lb)
With Tracking Generator	4.95 kg (10.91 lb)
Calibration Interval	
Recommended Calibration Interval	18 months

Input/Output

Front Panel Connector			
RF Input	Impedance	50 Ω (nominal)	
	Connector	N-type female	
TG Output	Impedance	50 Ω (nominal)	
	Connector	N-type female	
Internal/External Reference			
Internal Reference	Frequency	10 MHz	
	Output Level	+3 dBm to +10 dBm, +7 dBm (typical)	
	Impedance	50 Ω (nominal)	
	Connector	BNC female	
External Reference	Frequency	10 MHz ± 5 ppm	
	Input Level	0 dBm to +10 dBm	
	Impedance	50 Ω (nominal)	
	Connector	BNC female	
External Trigger Input/Output			
External Trigger Input 1	Impedance	≥ 1 kΩ (nominal)	
	Connector	BNC female	
	Level	5 V TTL level	
External Trigger Input 2/Trigger Output	Impedance	on trigger input	≥ 1 kΩ (nominal)
		on trigger output	50 Ω (nominal)
	Connector	BNC female	
	Level	5 V TTL level	
IF Output			
IF Output	Frequency	430 MHz ± 20 MHz (nominal)	
	Amplitude	RF input power (PRFin) ≤ -10 dBm, attenuation = 0, preamp off.	
		50MHz, PRFin ± 4 dB (nominal) other frequency, PRFin ± 4 dB + RF frequency response (nominal)	
	Impedance	50 Ω (nominal)	
Connector	SMB male		
Communication Interface			
USB Host (4 ports)	Connector	A plug	
	Protocol	version 2.0	
USB Device	Connector	B plug	
	Protocol	version 2.0	
LAN	Connector	100/1000Base, RJ-45	
	Protocol	LXI Core 2011 Device	
HDMI	Connector	A plug	
	Protocol	HDMI 1.4b	

► Order Information

	Description	Order No .
Model	Real-time Spectrum Analyzer, 9 kHz to 3.2 GHz	RSA5032
	Real-time Spectrum Analyzer, 9 kHz to 6.5 GHz	RSA5065
	Real-time Spectrum Analyzer, 9 kHz to 3.2 GHz (include TG)	RSA5032-TG
	Real-time Spectrum Analyzer, 9 kHz to 6.5 GHz (include TG)	RSA5065-TG
	Real-time Spectrum Analyzer, 9 kHz to 3.2 GHz (include TG and VNA)	RSA5032N
	Real-time Spectrum Analyzer, 9 kHz to 6.5 GHz (include TG and VNA)	RSA5065N
Standard Accessories	Quick Guide (hard copy)	-
	Power Cable	-
Option	Vector Signal Analysis Measurement Application	RSA5000-VSA
	EMI Measurement Application	RSA5000-EMI
	Preamplifier (PA)	RSA5000-PA
	High Stability Clock	OCXO-C08
	Real-time/Analysis Bandwidth 40 MHz	RSA5000-B40
	Advanced Measurement Kit	RSA5000-AMK
	Spectrum Analyzer PC Software	Ultra Spectrum
	EMI Pre-compliance Test Software	S1210 EMI Pre-compliance Software
Optional Accessories	High-performance Network Analysis Calibration Kit(frequency range: DC to 6.5 GHz)	CK106A
	Economical Network Analysis Calibration Kit(frequency range: DC to 1.5 GHz)	CK106E
	Include: N-SMA cable, BNC-BNC cable, N-BNC adaptor, N-SMA adaptor, 75 Ω-50 Ω adaptor, 900 MHz/1.8 GHz antenna (2pcs), 2.4 GHz antenna (2pcs)	DSA Utility Kit
	Include: N(F)-N(F) adaptor (1pcs), N(M)-N(M) adaptor (1pcs), N(M)-SMA(F) adaptor (2pcs), N(M)-BNC(F) adaptor (2pcs), SMA(F)-SMA(F) adaptor (1pcs), SMA(M)-SMA(M) adaptor (1pcs), BNC T type adaptor (1pcs), 50 Ω SMA load (1pcs), 50 Ω BNC impedance adaptor (1pcs)	RF Adaptor Kit
	Include: 50 Ω to 75 Ω adaptor (2pcs)	RF CATV Kit
	Include: 6 dB attenuator (1pcs), 10 dB attenuator (2pcs)	RF Attenuator Kit
	30 dB high-power attenuator, with the max power of 100 W	ATT03301H
	N(M)-N(M) RF Cable	CB-NM-NM-75-L-12G
	N(M)-SMA(M) RF Cable	CB-NM-SMAM-75-L-12G
	VSWR Bridge, 1 MHz to 3.2 GHz	VB1032
	VSWR Bridge, 2 GHz to 8 GHz	VB1080
	Near-field Probe	NFP-3
	Rack Mount Kit	RM6041
	USB Cable	CB-USBA-USBB-FF-150

Warranty

Three years for the mainframe.

HEADQUARTER

RIGOL TECHNOLOGIES CO., LTD.
No.8 Keling Road, New District,Suzhou,
JiangSu,P.R.China
Tel:+86-400620002
Email:info@rigol.com

EUROPE

RIGOL TECHNOLOGIES EU GmbH
Lindbergh str. 4
82178 Puchheim
Germany
Tel: +49-89/89418950
Email: info-europe@rigol.com

NORTH AMERICA

RIGOL TECHNOLOGIES, USA INC.
8140 SW Nimbus Ave.
Beaverton, OR 97008
Tel: +1-877-4-**RIGOL**-1
Fax: +1-877-4-**RIGOL**-1
Email: info@rigol.com

JAPAN

RIGOL TECHNOLOGIES JAPAN, LLC
MJ Bldg. 3F, 1-7-4 Minato, Chuou-ku,
Tokyo, Japan 104-0043
Tel: +81-3-6262-8932
Fax: +81-3-6262-8933
Email: info-japan@rigol.com

RIGOL® is the trademark of **RIGOL** TECHNOLOGIES CO., LTD. Product information in this document subject to update without notice. For the latest information about **RIGOL**'s products, applications and services, please contact local **RIGOL** Channel Partners or access **RIGOL** official website: www.rigol.com