

Identical User Interfaces

Vout from 7.5V to 1500V (10kW and 15kW)

AC Inputs include 3-Phase 208VAC, 400VAC and 480VAC

Genesys™

Programmable DC Power Supplies
Full-Rack 10kW/15kW in 3U Height
Built in RS-232 & RS-485 Interface
Parallel Operation (Basic or Advanced)

Optional Interfaces:

LAN (**LXI** 1.5 compliant w/ Multi-Drop)

IEEE (488.2 & SCPI compliant w/ Multi-Drop)

USB (2.0 w/ Multi-Drop)

Isolated Analog (5V/10V or 4-20mA Pgm/Mon)



Genesys™ Family

GENH-1U 750W Half-Rack

GEN-1U 750W-1.5kW-2.4kW Full-Rack

GEN-2U 3.3kW-5.0kW Full-Rack

GEN-3U 10kW-15kW Full-Rack

TDK-Lambda

www.us.lambda.tdk.com

The Genesys™ family of programmable power supplies sets a new standard for flexible, reliable, AC/DC power systems in OEM, Industrial and Laboratory applications.

Features include:

- High Power Density 10kW/15kW in Full-Rack 3U package
- High Output Current (up to 1000ADC)
- Popular worldwide 3Φ AC inputs, (208VAC, 400VAC, 480VAC)
- Power Factor 0.88 (Passive PFC on all 3Φ AC Inputs)
- Output Voltage from 7.5V (1000A) to 1500V (10A)
- Built-in RS-232/RS-485 Serial Interface (standard)
- Last Setting Memory, Safe/Auto-ReStart, Front Panel Lock/Unlock
- “Advanced Parallel” configuration reports total system current (up to four identical units)
- Global Commands for RS-232/RS-485 Serial Interface
- Continuous Encoders for Voltage and Current Adjustment (COARSE & FINE mode)
- Independent Remote SHUTOFF and Remote ENABLE/DISABLE
- 19” Rack Mounted for ATE and OEM Applications; zero-stack capability
- Optional Interfaces
 - **LXI** 1.5 compliant LAN w/ Multi-Drop capability: option for all models
 - IEEE (488.2 & SCPI compliant) w/ Multi-Drop capability: option for all models
 - USB (2.0) w/ Multi-Drop capability: option for all models
 - Isolated Analog Programming and Monitoring Interface
 - 0-5V/0-10V: option for models with $V_{out} \leq 600V$, standard for models with $V_{out} \geq 800V$
 - 4-20mA: option for all models
- LabView™ and LabWindows™ Instrument Software Drivers
- Worldwide Safety Agency Approvals: UL/cUL/EN 61010-1 ($20V \leq V_{out} \leq 1500V$); UL/cUL/EN 60950-1 ($V_{out} < 20V$)
- Five Year Warranty

Applications

Genesys™ power supplies are designed for demanding applications.

Test & Measurement systems using GPIB control save significant costs by incorporating the optional IEEE Multi-Drop Interface (IEMD) in the Master unit. This allows up to 30 Slave units to be used with the standard RS-485 Multi-Drop Serial interface.

Automated System designers will appreciate new, standard, remote programming features such as Global commands. Also, new high-speed status monitoring is available for the standard RS-485 and optional LAN (LXI compliant) Interface.

Industrial & Military high power systems can be configured with up to four identical units in parallel (up to 60kW). No space is required above or below each power supply (zero-stack). The Master unit can be configured by the user to report the total Output current of the combined system. Applications include Heaters, Magnets and Laser Diodes.

Aerospace & Satellite Testing systems use the complete Genesys™ Family: 1U-750W Half-Rack, 1U-750W/1.5kW/2.4kW Full-Rack, 2U-3.3kW/5kW Full-Rack and 3U-10kW/15kW Full-Rack. All are identical in Front Panel, Rear Panel Analog and Digital Interface commands. A wide variety of Outputs (voltage and current) allows testing of many different user configurations.

Component Device Testing is simplified because of the many user-friendly control options in the Analog and Digital interfaces. Lamps, capacitors, motors and actuators are typical devices tested.

Medical Imaging and Treatment systems require reliable power. Modular construction, SMT and thoroughly proven designs assure continuous performance at full rated power.

Semiconductor Processing & Burn-in equipment designers appreciate the wide variety of worldwide AC Inputs and DC Outputs from which to select, depending on application. Selectable Safe-Start and Auto Re-Start protects loads and process integrity. Typical applications include Magnets, Filaments and Heaters.

Front Panel Description ($7.5V \leq V_{out} < 20V$)

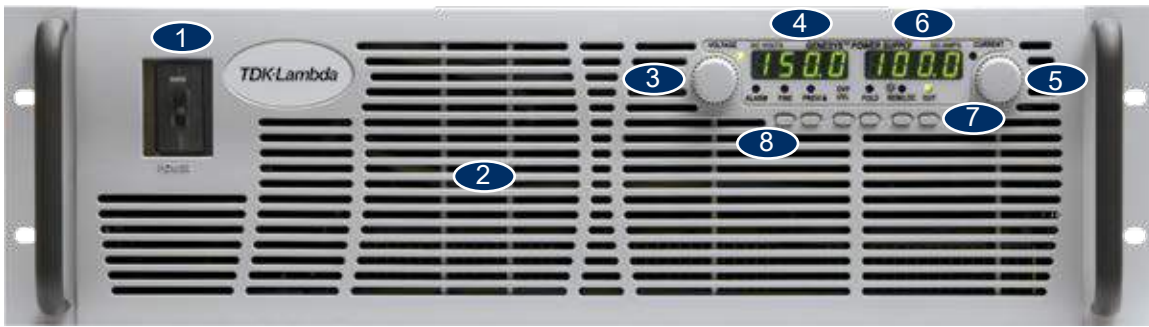

1. AC ON/OFF Switch (circuit breaker for $V_{out} < 20V$; rocker switch for $V_{out} \geq 20V$ models)
2. Air Intake allows zero-stacking for maximum system flexibility and power density.
3. Continuous encoder controls Output Voltage, Address, OVP and UVL settings.
4. Voltage Display shows Output Voltage and directly displays OVP, UVL and Address settings.
5. Continuous encoder controls Output Current, sets Baud rate and Advanced Parallel mode.
6. Current Display shows Output Current and displays Baud rate. Displays total current in Parallel Master/Slave Mode.
7. Function/Status LEDs:
 - Alarm
 - Foldback Mode
 - Fine Control
 - Remote Mode
 - Preview Settings
 - Output On
8. Pushbuttons allow flexible user configuration
 - Coarse and Fine adjustment of Output Voltage/Output Current and Advanced Parallel Master or Slave select.
 - Preview Settings and set Voltage/Current with Output OFF, Front Panel Lock/Unlock.
 - Parallel Master/Slave (Basic and Advanced).
 - Set Output OVP and UVL Limits.
 - Set Output Current Foldback Protection.
 - Go to Local Mode and select unit Address and Baud rate.
 - Output ON/OFF and Safe-Start/Auto Re-Start mode.

Rear Panel Description ($7.5V \leq V_{out} < 20V$)

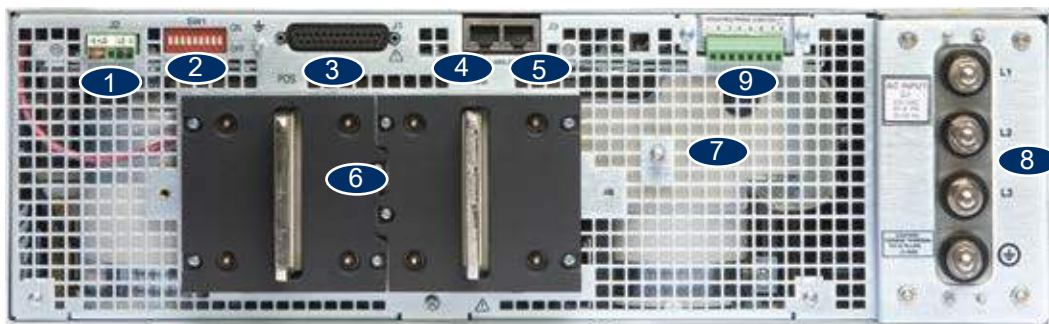

1. Remote/Local Output Voltage Sense Connections.
2. DIP Switches select 0-5V or 0-10V Programming and other functions.
3. DB25 (Female) connector allows Analog Program and Monitor (non-isolated) and other functions.
4. RS-485 OUT to other Genesys™ Power Supplies.
5. RS-232/RS-485 IN Remote Serial Programming.
6. Output Connectors: Rugged 2 hole busbars (shown) for models where $V_{out} < 20V$, single hole busbars for $20V \leq V_{out} \leq 300V$ Output, and threaded-stud terminals for models where $V_{out} > 300V$.
7. Exit air assures reliable operation when zero-stacked.
8. Input Terminals L1, L2, L3, and Ground (threaded studs).
9. Optional location for LAN (LXI 1.5), IEEE (488.2 & SCPI compliant), USB (2.0) or Isolated Analog Interface.

Genesys™ 3U 10kW Specifications

| 1.0 MODEL | GEN | 7.5-1000 | 10-1000 | 12.5-800 | 20-500 | 25-400 | 30-333 | 40-250 | 50-200 | 60-167 | 80-125 | 100-100 | 125-80 | 10kW |
|---|-----|----------|---------|----------|--------|--------|--------|--------|--------|--------|--------|---------|--------|------|
| 1. Rated Output Voltage | VDC | 7.5 | 10 | 12.5 | 20 | 25 | 30 | 40 | 50 | 60 | 80 | 100 | 125 | X |
| 2. Rated Output Current | ADC | 1000 | 1000 | 800 | 500 | 400 | 333 | 250 | 200 | 167 | 125 | 100 | 80 | X |
| 3. Rated Output Power | kW | 7.5 | 10.0 | 10.0 | 10.0 | 10.0 | 10.0 | 10.0 | 10.0 | 10.0 | 10.0 | 10.0 | 10.0 | X |
| 4. Efficiency (min) at low AC line, 100% Rated Load | % | 77 | 83 | | | | | | | | | | | X |
| Contact Factory for other models | | | | | | | | | | | | | | |

| 1.1 CONSTANT VOLTAGE MODE (CV) | | | | | | | | | | | | | | | |
|--|----------|---|----|------|----|----|-----|----|----|----|-----|-----|------|---|---|
| 1. Max. Line Reg (0.1% - Vor ≤ 30V; 0.05% - 30V < Vor ≤ 600V; 0.05% - 600V < Vor ≤ 1500V) | mV | 7.5 | 10 | 12.5 | 20 | 25 | 30 | 20 | 25 | 30 | 40 | 50 | 62.5 | X | |
| 2. Max. Load Reg (0.1% for Vor ≤ 30V; 0.05% for 30V < Vor ≤ 600V; 0.1% for 600V < Vor ≤ 1500V) | mV | 7.5 | 10 | 12.5 | 20 | 25 | 30 | 20 | 25 | 30 | 40 | 50 | 62.5 | X | |
| 3. Output Ripple, rms (5Hz~1MHz), CV mode; (*1) | mV | 20 | 20 | 20 | 20 | 20 | 20 | 20 | 20 | 20 | 25 | 25 | 25 | X | |
| 4. Output Noise, p-p (20MHz), CV mode; (*1) | mV | 60 | 60 | 60 | 60 | 60 | 60 | 60 | 75 | 75 | 100 | 100 | 125 | X | |
| 5. Remote Sense Compensation / Wire | V | 1 | 1 | 1 | 1 | 1 | 1.5 | 2 | 3 | 3 | 4 | 5 | 5 | X | |
| 6. Temperature Stability | --- | ± 0.05% of Vo(rated) over 8 hours after 30 minute warm up (constant Line, Load & Temperature) | | | | | | | | | | | | | X |
| 7. Temperature Coefficient | ppm / °C | ± 200 (± 0.02% of Vo(rated)) / °C | | | | | | | | | | | | | X |
| 8. Up-Prog. Response Time, 0~Vomax, full-load | ms | 100 | | | | | | | | | | | | | X |
| 9. Up-Prog. Response Time, 0~Vomax, no-load | ms | 50 | | | | | | | | | | | | | X |
| 10. Transient Response Time (CV mode); (*2), (*3) | ms | Less than 3 | | | | | | | | | | | | | X |

| 1.2 CONSTANT CURRENT MODE (CC) | | | | | | | | | | | | | | | |
|---|--------|--|------|------|------|-----|-----|-----|-----|------|------|----|----|---|---|
| 1. Max. Line Reg. (0.1% - Ior ≥ 333A; 0.050% - 17A < Ior < 333A; 0.15% - Ior < 17A) | mA | 1000 | 1000 | 800 | 500 | 400 | 333 | 125 | 100 | 83.5 | 62.5 | 50 | 40 | X | |
| 2. Max. Load Reg (0.1% - Ior ≥ 333A; 0.075% - 17A < Ior < 333A; 0.2% - Ior < 17A) | mA | 1000 | 1000 | 800 | 500 | 400 | 333 | 188 | 150 | 125 | 94 | 75 | 60 | X | |
| 3. Output Ripple, rms (5Hz~1MHz), CC mode | mA | 5300 | 4000 | 2560 | 1000 | 640 | 444 | 250 | 160 | 67 | 50 | 40 | 32 | X | |
| 4. Temperature Stability | --- | ± 0.05% of Io(rated) over 8 hours, after 30 minute warm up (constant Line, Load & Temperature) | | | | | | | | | | | | | X |
| 5. Temperature Coefficient | ppm/°C | ± 300 (± 0.03% of Io(rated)) / °C | | | | | | | | | | | | | X |

| 1.3 PROTECTIVE FUNCTIONS | | | | | | | | | | | | | | | |
|---------------------------------------|-----|--|--|--|--|--|--|--|--|--|--|--|--|--|---|
| 1. OCP | % | 0 ~ 100 | | | | | | | | | | | | | X |
| 2. OCP type | --- | Constant current | | | | | | | | | | | | | X |
| 3. Foldback Protection (FOLD) | --- | Output shutdown; Manual reset by front panel OUT button or Digital communication, user-selectable | | | | | | | | | | | | | X |
| 4. Foldback Response Time | s | Less than 1 (Min = 0.25 / Max = 25 / Default = 0.25); Settable via "FBD" command | | | | | | | | | | | | | X |
| 5. OVP type | --- | Inverter shut-down; Manual reset by AC On/Off recycle, OUT button, Remote Analog or Digital communication | | | | | | | | | | | | | X |
| 6. OVP Programming Accuracy | % | ± 5% of Vo(rated) | | | | | | | | | | | | | X |
| 7. OVP Trip Point | V | 5% to 105% of Vo(rated) for Vor ≤ 600V; 10% to 105% of Vo(rated) for 600V < Vor ≤ 1500V Shall always be greater than 105% of Vo(setting); Default = 105% of Vo(rated) | | | | | | | | | | | | | X |
| 8. OVP Response Time | ms | Less than 10 (for Output to begin to drop) for Vor ≤ 600V Less than 2.0 (for Output to begin to drop) for 600V < Vor ≤ 1500V | | | | | | | | | | | | | X |
| 9. Max. OVP Reset Time | s | 7 (from AC On/Off switch turn On) | | | | | | | | | | | | | X |
| 10. Over-Temperature Protection (OTP) | --- | Shut down if internal temperature exceeds safe operating levels (Latched: Safe / Unlatched: Auto) | | | | | | | | | | | | | X |
| 11. Phase-Loss Protection | --- | Yes, power supply shutdown (Latched: Safe-Start / Unlatched: Auto-Restart) | | | | | | | | | | | | | X |

| 1.4 REMOTE ANALOG CONTROLS & SIGNALS | | | | | | | | | | | | | | | |
|---------------------------------------|--|--|--|--|--|--|--|--|--|--|--|--|--|--|---|
| 1. Vout Voltage Programming | | 0~100%, 0 ~ 5V or 0 ~ 10V, user-selectable., Accuracy & Linearity: ±1% of Vo(rated) | | | | | | | | | | | | | X |
| 2. Iout Voltage Programming | | 0~100%, 0 ~ 5V or 0 ~ 10V, user-selectable, Accuracy & Linearity: ± 1% of Io(rated) | | | | | | | | | | | | | X |
| 3. Vout Resistor Programming | | 0~100%, 0 ~ 5/10kohm full-scale, user-selectable, Accuracy & Linearity: ± 1% of Vo(rated) | | | | | | | | | | | | | X |
| 4. Iout Resistor Programming | | 0~100%, 0 ~ 5/10kohm full-scale, user-selectable, Accuracy & Linearity: ± 1% of Io(rated) | | | | | | | | | | | | | X |
| 5. Shut-Off (SO) Control (rear panel) | | By Voltage: 0.6V = DIS, 2-15V = ENA (default) or by Dry Contact: Open = ENA, Short = DIS (user-selectable logic) | | | | | | | | | | | | | X |
| 6. Output Current Monitor | | 0 ~ 5V or 0 ~ 10V, Accuracy: ± 1% of Io(rated), user-selectable | | | | | | | | | | | | | X |
| 7. Output Voltage Monitor | | 0 ~ 5V or 0 ~ 10V, Accuracy: ± 1% of Vo(rated), user-selectable | | | | | | | | | | | | | X |
| 8. Power Supply OK (PS_OK) Signal | | Yes. TTL High = OK, 0V = Fail (500ohm series impedance) | | | | | | | | | | | | | X |
| 9. CV/CC Signal | | CV: TTL High (4 ~ 5V), Max source current = 10mA; CC: TTL Low (0 ~ 0.4V), Max sink current = 10mA | | | | | | | | | | | | | X |
| 10. Enable/Disable | | Dry contact; Open = OFF, Short = ON; Maximum voltage across Enable/Disable contacts = 6V | | | | | | | | | | | | | X |
| 11. Remote/Local Selection | | Selects Remote or Local operation by voltage: 0 ~ 0.6V = Local / 2 ~ 15V = Remote | | | | | | | | | | | | | X |
| 12. Remote/Local Signal | | Signals operating mode; Open collector: Local = Open (Max voltage = 30V), Remote = On (Max sink current = 10mA) | | | | | | | | | | | | | X |

| 1.5 FRONT PANEL | | | | | | | | | | | | | | | |
|----------------------|--|---|--|--|--|--|--|--|--|--|--|--|--|--|---|
| 1. Control Functions | | Vout/ Iout manual adjust by separate encoders (COARSE and FINE adjustment selectable) | | | | | | | | | | | | | X |
| | | OVP/UVL manual adjust by VOLTAGE Adjust encoder, Front Panel Lock/Unlock | | | | | | | | | | | | | X |
| | | Address selection by VOLTAGE Adjust encoder. # of Addresses = 31 | | | | | | | | | | | | | X |
| | | AC ON/OFF, Output On/Off, Restart Modes (Auto/Safe), Foldback Control (CV to CC), Go-to-Local | | | | | | | | | | | | | X |
| | | RS-232/RS-485, LAN, IEEE (IEMD) and USB selection by rear panel DIP-switch | | | | | | | | | | | | | X |
| 2. Display | | Baud rate selection (RS-232/RS-485 only): 1200, 2400, 4800, 9600 and 19,200 (by CURRENT Adjust encoder) | | | | | | | | | | | | | X |
| | | Advanced Parallel Master/Slave: Hx = Master unit, where x = # of Slave units (0 to 4), S = Slave unit(s) | | | | | | | | | | | | | X |
| | | Voltage: 4 digits, Accuracy: ± 0.5% of Vo(rated) ±1 count | | | | | | | | | | | | | X |
| 3. Indications | | Current: 4 digits, Accuracy: ± 0.5% of Io(rated) ±1 count | | | | | | | | | | | | | X |
| | | VOLTAGE meter displays voltage at power supply (Local sense) or at load (Remote sense) | | | | | | | | | | | | | X |
| | | Green LED's: PREVIEW, FOLD, REM/LOCAL, OUT ON/OFF, CV/CC, FINE Red LED: ALARM (OVP, OTP, FOLD, AC FAIL, ENA, SO) | | | | | | | | | | | | | X |

| 1.6 DIGITAL PROGRAMMING & READBACK | | | | | | | | | | | | | | | |
|------------------------------------|--|---|--|--|--|--|--|--|--|--|--|--|--|--|---|
| 1. Vout Programming Accuracy | | ± 0.5% of Vo(rated) | | | | | | | | | | | | | X |
| 2. Iout Programming Accuracy | | ± 0.5% of Io(rated) for units with Io < 187.5A; ± 0.7% of Io(rated) for Io ≥ 187.5A | | | | | | | | | | | | | X |
| 3. Vout Programming Resolution | | 0.02% of Vo(rated) | | | | | | | | | | | | | X |
| 4. Iout Programming Resolution | | 0.04% of Io(rated) | | | | | | | | | | | | | X |
| 5. Vout Readback Accuracy | | ± (0.1% of Vo(actual) + 0.2% of Vo(rated)) | | | | | | | | | | | | | X |
| 6. Iout Readback Accuracy | | ± (0.1% of Io(actual) + 0.4% of Io(rated)) | | | | | | | | | | | | | X |
| 7. Vout Readback Resolution | | 0.02% of Vo(rated) | | | | | | | | | | | | | X |
| 8. Iout Readback Resolution | | 0.02% of Io(rated) | | | | | | | | | | | | | X |
| 9. OV Response Time | | 20ms maximum (between Vout exceeding IEEE Limit and supply Inhibit turning On) | | | | | | | | | | | | | X |
| 10. Other Functions | | Set OVP/UVL limits; Set Local/Remote, Operating parameters and Status, Get Identity | | | | | | | | | | | | | X |

*1 Ripple and Noise at Vo(rated) and rated Load, Ta = +25C and nominal AC Input per EIJ R900A.
 *2. Time for the Output voltage to recover within 2% of rating for a load current change of 50~100% or 100-50% of Io(rated).
 *3. Operating with a load that continuously pulses the current (or voltage) can reduce the operating life of the Power Supply. Please contact TDK-Lambda Sales/Technical Support to discuss the application in detail.
 All specifications subject to change without notice.

Genesys™ 3U 10kW Specifications

| | | | | | | | | | | | 10kW | | |
|---|---|--|--------|--------|--------|--------|--------|--------|-------------|---------|--------|----------|---|
| 1.0 MODEL | GEN | 150-66 | 200-50 | 250-40 | 300-33 | 400-25 | 500-20 | 600-17 | 800-12.5 | 1000-10 | 1250-8 | 1500-6.7 | X |
| 1. Rated Output Voltage | VDC | 150 | 200 | 250 | 300 | 400 | 500 | 600 | 800 | 1000 | 1250 | 1500 | X |
| 2. Rated Output Current | ADC | 66 | 50 | 40 | 33 | 25 | 20 | 17 | 12.5 | 10 | 8.0 | 6.7 | X |
| 3. Rated Output Power | kW | 9.9 | 10.0 | 10.0 | 9.9 | 10.0 | 10.0 | 10.2 | 10.0 | 10.0 | 10.0 | 10.0 | X |
| 4. Efficiency (min) at low AC line, 100% Rated Load | % | 83 | | | | | | | 93.5 | | | | X |
| 1.1 CONSTANT VOLTAGE MODE (CV) | Contact Factory for other models | | | | | | | | | | | | X |
| 1. Max. Line Reg (0.1% - Vor ≤ 30V; 0.05% - 30V < Vor ≤ 600V; 0.05% - 600V < Vor ≤ 1500V) | mV | 75 | 100 | 125 | 150 | 200 | 250 | 300 | 400 | 500 | 625 | 750 | X |
| 2. Max. Load Reg (0.1% - Vor ≤ 30V; 0.05% - 30V < Vor ≤ 600V; 0.1% - 600V < Vor ≤ 1500V) | mV | 75 | 100 | 125 | 150 | 200 | 250 | 300 | 800 | 1000 | 1250 | 1500 | X |
| 3. Output Ripple, rms (5Hz~1MHz), CV mode; (*1) | mV | 25 | 35 | 35 | 60 | 60 | 60 | 60 | 80 | 100 | 120 | 140 | X |
| 4. Output Noise, p-p (20MHz), CV mode; (*1) | mV | 150 | 175 | 200 | 200 | 300 | 350 | 350 | 700 | 800 | 1000 | 1400 | X |
| 5. Remote Sense Compensation / Wire | V | 5 | 5 | 5 | 5 | 5 | 5 | 5 | 5 | 5 | 5 | 5 | X |
| 6. Temperature Stability | --- | ± 0.05% of Vo(rated) over 8 hours after 30 minute warm up (constant Line, Load & Temperature) | | | | | | | | | | | X |
| 7. Temperature Coefficient | ppm / °C | ± 200 (0.02% of Vo(rated)) / °C | | | | | | | | | | | X |
| 8. Up-Prog. Response Time, 0~Vomax, full-load | ms | 100 | | | | | | | 17 | | | | X |
| 9. Up-Prog. Response Time, 0~Vomax, no load | ms | 50 | | | | | | | 17 | | | | X |
| 10. Transient Response Time (CV mode); (*2), (*3) | ms | Less than 3 | | | | | | | Less than 1 | | | | X |
| 1.2 CONSTANT CURRENT MODE (CC) | | | | | | | | | | | | | |
| 1. Max. Line Reg (0.1% - Ior ≥ 333A; 0.050% - 17A < Ior < 333A; 0.15% - Ior < 17A) | mA | 33 | 25 | 20 | 17 | 13 | 10 | 9 | 19 | 15 | 12 | 10 | X |
| 2. Max. Load Reg (0.1% - Ior ≥ 333A; 0.075% - 17A ≤ Ior < 333A; 0.2% - Ior < 17A) | mA | 50 | 38 | 30 | 25 | 19 | 15 | 13 | 25 | 20 | 15 | 14 | X |
| 3. Output Ripple, rms (5Hz~1MHz), CC mode | mA | 26 | 20 | 16 | 13 | 10 | 8 | 7 | 15 | 10 | 6 | 4 | X |
| 4. Temperature Stability | --- | ± 0.05% of Io Rated over 8 hours after 30 minute warm up (constant Line, Load & Temperature) | | | | | | | | | | | X |
| 5. Temperature Coefficient | ppm / °C | ± 300 (0.03% of Io(rated)) / °C | | | | | | | | | | | X |
| 1.3 PROTECTIVE FUNCTIONS | | | | | | | | | | | | | |
| 1. OCP | % | 0 ~ 100 | | | | | | | | | | | X |
| 2. OCP type | --- | Constant current | | | | | | | | | | | X |
| 3. Foldback Protection (FOLD) | --- | Output shut down; Manual reset by front panel OUT button or Digital communication, user-selectable | | | | | | | | | | | X |
| 4. Foldback Response Time | s | Less than 1 (Min = 0.25 / Max = 25 / Default = 0.25); Settable via "FBD" command | | | | | | | | | | | X |
| 5. OVP type | --- | Inverter shut-down; Manual reset by AC On/Off recycle, OUT button, Remote Analog or Digital comm. | | | | | | | | | | | X |
| 6. OVP Programming Accuracy | % | ± 5% of Vo(rated) | | | | | | | | | | | X |
| 7. OVP Trip Point | V | 5% to 105% of Vo(rated) - for Vor ≤ 600V; 10% to 105% of Vo(rated) - 600V < Vor ≤ 1500V Shall always be greater than 105% of Vo(setting); Default = 105% of Vo(rated) | | | | | | | | | | | X |
| 8. OVP response time | ms | Less than 10 (for Output to begin to drop) for Vor ≤ 600V Less than 2.0 (for Output to begin to drop) for 600V < Vor ≤ 1500V | | | | | | | | | | | X |
| 9. Max. OVP reset time | s | 7 (from AC On/Off switch turn On) | | | | | | | | | | | X |
| 10. Over-Temperature Protection (OTP) | --- | Shut down if internal temperature exceeds safe operating levels. (Latched: Safe / Unlatched: Auto) | | | | | | | | | | | X |
| 11. Phase-Loss Protection | --- | Yes, power supply shutdown (Latched: Safe-Start / Unlatched: Auto-Restart) | | | | | | | | | | | X |
| 1.4 REMOTE ANALOG CONTROLS & SIGNALS | | | | | | | | | | | | | |
| 1. Vout Voltage Programming | 0~100%, 0 ~ 5V or 0 ~ 10V, user-selectable. Accuracy & Linearity: ± 1% of Vo(rated) | | | | | | | | | | | | X |
| 2. Iout Voltage Programming | 0 ~ 100%, 0~5V or 0 ~ 10V, user-selectable. Accuracy & Linearity ± 1% of Io(rated) | | | | | | | | | | | | X |
| 3. Vout resistor programming | 0~100%, 0~5/10kohm full-scale, user-selectable. Accuracy & Linearity ± 1% of Vo(rated) | | | | | | | | | | | | X |
| 4. Iout Resistor Programming | 0~100%, 0~5/10kohm full-scale, user-selectable. Accuracy & Linearity ± 1% of Io(rated) | | | | | | | | | | | | X |
| 5. Shut-Off (SO) Control (rear panel) | By Voltage: 0.6V = DIS, 2-15V = ENA (default) or Dry Contact : Open = ENA, Short = DIS (user-selectable logic) | | | | | | | | | | | | X |
| 6. Output Current Monitor | 0 ~ 5V or 0 ~ 10V, Accuracy: ± 1% of Io(rated), user-selectable | | | | | | | | | | | | X |
| 7. Output Voltage Monitor | 0 ~ 5V or 0 ~ 10V, Accuracy: ± 1% of Vo(rated), user-selectable | | | | | | | | | | | | X |
| 8. Power Supply OK (PS_OK) Signal | Yes. TTL high = OK, 0V = Fail (500ohm series impedance) | | | | | | | | | | | | X |
| 9. CV/CC Signal | CV: TTL High (4 ~ 5V), Max source current = 10mA; CC: TTL Low (0 ~ 0.4V), Max sink current = 10mA | | | | | | | | | | | | X |
| 10. Enable/Disable | Dry contact; Open = OFF, Short = ON; Maximum voltage across Enable/Disable contacts = 6V | | | | | | | | | | | | X |
| 11. Remote/Local Selection | Selects Remote or Local operation by voltage: 0 ~ 0.6V = Local / 2 ~ 15V = Remote | | | | | | | | | | | | X |
| 12. Remote/Local Signal | Signals operating mode; Open collector: Local = Open (Max voltage = 30V), Remote = On (Max sink current = 10mA) | | | | | | | | | | | | X |
| 1.5 FRONT PANEL | | | | | | | | | | | | | |
| 1. Control Functions | Vout/ Iout manual adjust by separate encoders (COARSE and FINE adjustment selectable) OVP/UVL manual adjust by VOLTAGE Adjust encoder, Front Panel Lock/Unlock Address selection by Voltage Adjust encoder. # of Addresses = 31 AC ON/OFF, Output On/Off, Restart Modes (Auto/Safe), Foldback Control (CV to CC), Go-to-Local RS-232/RS-485, LAN, IEEE (IEMD) and USB selection by rear-panel DIP-switch Baud rate selection (RS-232/RS-485 only): 1200, 2400, 4800, 9600 and 19,200 (by CURRENT Adjust encoder) Advanced Parallel Master/Slave: Hx = Master unit, where x = # of Slave units (0 to 4), Slave = Slave unit(s) | | | | | | | | | | | X | |
| 2. Display | Voltage: 4 digits, Accuracy: ± 0.5% of Vo(rated) ±1 count Current: 4 digits, Accuracy: ± 0.5% of Io(rated) ±1 count VOLTAGE meter displays voltage at power supply (Local sense) or at load (Remote sense) | | | | | | | | | | | X | |
| 3. Indications | Green LED's: PVIEW, FOLD, REMLOCAL, OUT ON/OFF, CV/CC, FINE Red LED: ALARM (OVP, OTP, FOLD, AC FAIL, ENA, SO) | | | | | | | | | | | X | |
| 1.6 DIGITAL PROGRAMMING & READBACK | | | | | | | | | | | | | |
| 1. Vout Programming Accuracy | ± 0.5% of Vo(rated) | | | | | | | | | | | X | |
| 2. Iout Programming Accuracy | ± 0.5% of Io(rated) for units with Io < 187.5A; ± 0.7% of Io(rated) for Io ≥ 187.5A | | | | | | | | | | | X | |
| 3. Vout Programming Resolution | 0.02% of Vo(rated) | | | | | | | | | | | X | |
| 4. Iout Programming Resolution | 0.04% of Io(rated) | | | | | | | | | | | X | |
| 5. Vout Readback Accuracy | ± (0.1% of Vo(actual) + 0.2% of Vo(rated)) | | | | | | | | | | | X | |
| 6. Iout Readback Accuracy | ± (0.1% of Io(actual) + 0.4% of Io(rated)) | | | | | | | | | | | X | |
| 7. Vout Readback Resolution | 0.02% of Vo(rated) | | | | | | | | | | | X | |
| 8. Iout Readback Resolution | 0.02% of Io(rated) | | | | | | | | | | | X | |
| 9. OV Response Time | 20ms maximum (between Vout exceeding IEEE Limit and supply Inhibit turning On) | | | | | | | | | | | X | |
| 10. Other Functions | Set OVP/UVL limits; Set Local/Remote, Operating Parameters and Status; Get Identity | | | | | | | | | | | X | |

*1. Ripple and Noise at Vo(rated) and rated Load, Ta = +25°C and nominal AC input, per EIJ R9002A

*2. Time for the Output voltage to recover within 2% of rating for a load current change of 50~100% or 100~50% of Io(rated).

*3. Operating with a load that continuously pulses the current (or voltage) can reduce the operating life of the Power Supply. Please contact TDK-Lambda Sales/Technical Support to discuss the application in detail.

All specifications subject to change without notice.

Genesys™ 3U 15kW Specifications

| | GEN | N/A | N/A | N/A | N/A | N/A | 30-500 | 40-375 | 50-300 | 60-250 | 80-187.5 | 100-150 | 125-120 | 15kW |
|---|-----|-----|-----|-----|-----|-----|--------|--------|--------|--------|----------|---------|---------|------|
| 1.0 MODEL | | | | | | | | | | | | | | X |
| 1. Rated Output Voltage | VDC | --- | --- | --- | --- | --- | 30 | 40 | 50 | 60 | 80 | 100 | 125 | X |
| 2. Rated Output Current | ADC | --- | --- | --- | --- | --- | 500 | 375 | 300 | 250 | 187.5 | 150 | 120 | X |
| 3. Rated Output Power | KW | --- | --- | --- | --- | --- | 15.0 | 15.0 | 15.0 | 15.0 | 15.0 | 15.0 | 15.0 | X |
| 4. Efficiency (min) at low AC line, 100% Rated Load | % | --- | --- | --- | --- | --- | | | | 88 | | | | X |
| Contact Factory for other models | | | | | | | | | | | | | | |
| | | | | | | | | | | | | | | X |

1.1 CONSTANT VOLTAGE MODE (CV)

| | | | | | | | | | | | | | | |
|---|----------|---|-----|-----|-----|-----|-----|----|----|----|-----|-----|------|---|
| 1. Max. Line Reg (0.1% - Vor ≤ 30V; 0.05% - 30V < Vor ≤ 600V; 0.05% - 600V < Vor ≤ 1500V) | mV | --- | --- | --- | --- | --- | 30 | 20 | 25 | 30 | 40 | 50 | 62.5 | X |
| 2. Max. Load Reg (0.1% - Vor ≤ 30V; 0.05% - 30V < Vor ≤ 600V; 0.1% - 600V < Vor ≤ 1500V) | mV | --- | --- | --- | --- | --- | 30 | 20 | 25 | 30 | 40 | 50 | 62.5 | X |
| 3. Output Ripple, rms (5Hz~1MHz), CV mode; (*1) | mV | --- | --- | --- | --- | --- | 20 | 20 | 20 | 20 | 25 | 25 | 25 | X |
| 4. Output Noise, p-p (20MHz), CV mode; (*1) | mV | --- | --- | --- | --- | --- | 60 | 60 | 75 | 75 | 100 | 100 | 125 | X |
| 5. Remote Sense Compensation / Wire | V | --- | --- | --- | --- | --- | 1.5 | 2 | 3 | 3 | 4 | 5 | 5 | X |
| 6. Temperature Stability | --- | ± 0.05% of Vo(rated) over 8 hours after 30 minute warm up (constant Line, Load & Temperature) | | | | | | | | | | | | |
| 7. Temperature Coefficient | ppm / °C | ± 200 (± 0.02% of Vo(rated)) / °C | | | | | | | | | | | | |
| 8. Up-Prog. Response Time, 0 ~ Vomax, full-load | ms | 100 | | | | | | | | | | | | |
| 9. Up-Prog. Response Time, 0~Vomax, no load | ms | 50 | | | | | | | | | | | | |
| 10. Transient Response Time (CV mode); (*2), (*3) | ms | Less than 3 | | | | | | | | | | | | |

1.2 CONSTANT CURRENT MODE (CC)

| | | | | | | | | | | | | | | |
|---|--------|---|-----|-----|-----|-----|-----|-----|-----|-----|-----|-----|----|---|
| 1. Max. Line Reg. (0.1% - Ior ≥ 333A; 0.050% - Ior < 333A) | mA | --- | --- | --- | --- | --- | 500 | 375 | 334 | 125 | 94 | 75 | 60 | X |
| 2. Max. Load Reg (0.1% - Ior ≥ 333A; 0.075% - 25A ≤ Ior < 333A; 0.2% - Ior < 25A) | mA | --- | --- | --- | --- | --- | 500 | 375 | 334 | 188 | 141 | 113 | 90 | X |
| 3. Ripple, rms (5Hz~1MHz), CC mode | mA | --- | --- | --- | --- | --- | 350 | 200 | 150 | 100 | 100 | 100 | 50 | X |
| 4. Temperature Stability | --- | ± 0.05% of Io(rated) over 8 hours after 30 minute warm up (constant Line, Load & Temperature) | | | | | | | | | | | | |
| 5. Temperature Coefficient | ppm/°C | ± 300 (± 0.03% of Io(rated)) / °C | | | | | | | | | | | | |

1.3 PROTECTIVE FUNCTIONS

| | | | | | | | | | | | | | |
|---------------------------------------|-----|--|--|--|--|--|--|--|--|--|--|--|--|
| 1. OCP | % | 0 ~ 100 | | | | | | | | | | | |
| 2. OCP type | --- | Constant current | | | | | | | | | | | |
| 3. Foldback Protection (FOLD) | --- | Output shutdown; Manual reset by front panel OUT button or Digital communication, user-selectable | | | | | | | | | | | |
| 4. Foldback Response Time | s | Less than 1 (Min = 0.25 / Max = 25 / Default = 0.25); Settable via "FBD" command | | | | | | | | | | | |
| 5. OVP type | --- | Inverter shut-down; Manual reset by AC On/Off recycle, OUT button, Remote Analog or Digital communication | | | | | | | | | | | |
| 6. OVP Programming Accuracy | % | ± 5% of Vo(rated) | | | | | | | | | | | |
| 7. OVP Trip Point | V | 5% to 105% of Vo(rated) - for Vor ≤ 600V; 10% to 105% of Vo(rated) - 600V < Vor ≤ 1500V Shall always be greater than 105% of Vo(setting); Default = 105% of Vo(rated) | | | | | | | | | | | |
| 8. OVP Response Time | ms | Less than 10 (for Output to begin to drop) for Vor ≤ 600V Less than 2.0 (for Output to begin to drop) for 600V < Vor ≤ 1500V | | | | | | | | | | | |
| 9. Max. OVP Reset Time | s | 7 (from AC On/Off switch turn On) | | | | | | | | | | | |
| 10. Over-temperature Protection (OTP) | --- | Shut down if internal temperature exceeds safe operating levels (Latched: Safe / Unlatched: Auto) | | | | | | | | | | | |
| 11. Phase-Loss Protection | --- | Yes, power supply shutdown (Latched: Safe-Start / Unlatched: Auto-Restart) | | | | | | | | | | | |

1.4 REMOTE ANALOG CONTROLS & SIGNALS

| | | | | | | | | | | | | | |
|---------------------------------------|--|---|--|--|--|--|--|--|--|--|--|--|--|
| 1. Vout Voltage Programming | | 0~100%, 0 ~ 5V or 0 ~ 10V, user-selectable., Accuracy & Linearity: ±1% of Vo(rated) | | | | | | | | | | | |
| 2. Iout Voltage Programming | | 0~100%, 0 ~ 5V or 0 ~ 10V, user-selectable, Accuracy & Linearity: ± 1% of Io(rated) | | | | | | | | | | | |
| 3. Vout Resistor Programming | | 0~100%, 0 ~ 5/10kohm full-scale, user-selectable, Accuracy & Linearity: ± 1% of Vo(rated) | | | | | | | | | | | |
| 4. Iout Resistor Programming | | 0~100%, 0 ~ 5/10kohm full-scale, user-selectable, Accuracy & Linearity: ± 1% of Io(rated) | | | | | | | | | | | |
| 5. Shut-Off (SO) Control (rear panel) | | By Voltage: 0.6V = DIS, 2-15V = ENA (default) or Dry Contact: Open = ENA, Short = DIS (user-selectable logic) | | | | | | | | | | | |
| 6. Output Current Monitor | | 0 ~ 5V or 0 ~ 10V, Accuracy: ± 1% of Io(rated), user-selectable | | | | | | | | | | | |
| 7. Output Voltage Monitor | | 0 ~ 5V or 0 ~ 10V, Accuracy: ± 1% of Vo(rated), user-selectable | | | | | | | | | | | |
| 8. Power Supply OK (PS_OK) Signal | | Yes. TTL High = OK, 0V = Fail (500ohm series impedance) | | | | | | | | | | | |
| 9. CV/CC Signal | | CV: TTL High (4 ~ 5V), Max source current = 10mA; CC: TTL Low (0 ~ 0.4V), Max sink current = 10mA | | | | | | | | | | | |
| 10. Enable/Disable | | Dry contact: Open = OFF, Short = ON; Maximum voltage across Enable/Disable contacts = 6V | | | | | | | | | | | |
| 11. Remote/Local Selection | | Selects Remote or Local operation by voltage: 0 ~ 0.6V = Local / 2 - 15V = Remote | | | | | | | | | | | |
| 12. Remote/Local Signal | | Signals operating mode; Open collector: Local = Open (Max voltage = 30V), Remote = On (Max sink current = 10mA) | | | | | | | | | | | |

1.5 FRONT PANEL

| | | |
|----------------------|--|---|
| 1. Control Functions | Vout/ Iout manual adjust by separate encoders (COARSE and FINE adjustment selectable) | X |
| | OVP/UVL manual adjust by VOLTAGE Adjust encoder, Front Panel Lock/Unlock | X |
| | Address selection by VOLTAGE Adjust encoder. # of Addresses = 31 | X |
| | AC ON/OFF, Output On/Off, Restart Modes (Auto/Safe), Foldback Control (CV to CC), Go-to-Local | X |
| | RS-232/RS-485, LAN, IEEE (IEMD) and USB selection by rear panel DIP-switch | X |
| | Baud rate selection (RS-232/RS-485 only): 1200, 2400, 4800, 9600 and 19,200 (by Current Adjust encoder) | X |
| 2. Display | Advanced Parallel Master/Slave: Hx = Master unit, where x = # of Slave units (0 to 4); S = Slave unit(s) | X |
| | Voltage: 4 digits, Accuracy: ± 0.5% of Vo(rated) ±1 count | X |
| | Current: 4 digits, Accuracy: ± 0.5% of Vo(rated) ±1 count | X |
| 3. Indications | VOLTAGE meter displays voltage at power supply (Local sense) or at load (Remote sense) | X |
| | Green LED's: PREVIEW, FOLD, REM./LOCAL, OUT ON/OFF, CV/CC, FINE | X |
| | Red LED: ALARM (OVP, OTP, FOLD, AC FAIL, ENA, SO) | X |

1.6 DIGITAL PROGRAMMING & READBACK

| | | |
|--------------------------------|---|---|
| 1. Vout Programming Accuracy | ± 0.5% of Vo(rated) | X |
| 2. Iout Programming Accuracy | ± 0.5% of Io(rated) for units with Io < 187.5A; ± 0.7% of Io(rated) for Io ≥ 187.5A | X |
| 3. Vout Programming Resolution | 0.02% of Vo(rated) | X |
| 4. Iout Programming Resolution | 0.04% of Io(rated) | X |
| 5. Vout Readback Accuracy | ± (0.1% of Vo(actual) + 0.2% of Vo(rated)) | X |
| 6. Iout Readback Accuracy | ± (0.1% of Io(actual) + 0.4% of Io(rated)) | X |
| 7. Vout Readback Resolution | 0.02% of Vo(rated) | X |
| 8. Iout Readback Resolution | 0.02% of Io(rated) | X |
| 9. OV Response Time | 20ms maximum (between Vout exceeding IEEE Limit and supply Inhibit turning On) | X |
| 10. Other Functions | Set OVP/UVL limits, Set Local/Remote, Operating parameters and Status, Get Identity | X |

*1. Ripple and Noise at Vo(rated) and rated Load, Ta = 25C and nominal AC input, per EIJ R9002A.

*2. Time for the Output voltage to recover within 2% of rating for a load current change of 50~100% or 100~50% of rated Output.

*3. Operating with a load that continuously pulses the current (or voltage) can reduce the operating life of the Power Supply. Please contact TDK-Lambda Sales/Technical Support to discuss the application in detail.

All specifications subject to change without notice.

Genesys™ 3U 15kW Specifications

15kW

| 1.0 MODEL | GEN | 150-100 | 200-75 | 250-60 | 300-50 | 400-37.5 | 500-30 | 600-25 | 800-18.8 | 1000-15 | 1250-12 | 1500-10 | X |
|---|----------------------------------|--|--------|--------|--------|----------|--------|--------|-------------|---------|---------|---------|---|
| 1. Rated Output Voltage | VDC | 150 | 200 | 250 | 300 | 400 | 500 | 600 | 800 | 1000 | 1250 | 1500 | X |
| 2. Rated Output Current | ADC | 100 | 75 | 60 | 50 | 37.5 | 30 | 25 | 18.8 | 15 | 12 | 10 | X |
| 3. Rated Output Power | kW | 15.0 | 15.0 | 15.0 | 15.0 | 15.0 | 15.0 | 15.0 | 15.04 | 15.0 | 15.0 | 15.0 | X |
| 4. Efficiency (min) at low AC line, 100% Rated Load | % | 88 | | | | | | | 93.5 | | | | X |
| 1.1 CONSTANT VOLTAGE MODE (CV) | Contact Factory for other models | | | | | | | | | | | | X |
| 1. Max. Line Reg (0.1% - Vor ≤ 30V; 0.05% - 30V < Vor ≤ 600V; 0.05% - 600V < Vor ≤ 1500V) | mV | 75 | 100 | 125 | 150 | 200 | 250 | 300 | 400 | 500 | 625 | 750 | X |
| 2. Max. Load Reg (0.1% - Vor ≤ 30V; 0.05% - 30V < Vor ≤ 600V; 0.1% - 600V < Vor ≤ 1500V) | mV | 75 | 100 | 125 | 150 | 200 | 250 | 300 | 800 | 1000 | 1250 | 1500 | X |
| 3. Output Ripple, rms (5Hz~1MHz), CV mode; (*1) | mV | 25 | 35 | 35 | 60 | 60 | 60 | 60 | 80 | 100 | 120 | 140 | X |
| 4. Output Noise, p-p (20MHz), CV mode; (*1) | mV | 150 | 175 | 200 | 200 | 300 | 350 | 350 | 700 | 800 | 1000 | 1400 | X |
| 5. Remote Sense Compensation / Wire | V | 5 | 5 | 5 | 5 | 5 | 5 | 5 | 5 | 5 | 5 | 5 | X |
| 6. Temperature Stability | --- | ± 0.05% of Vo(rated) over 8 hours, after 30 minute warm up, constant Line, Load & Temperature | | | | | | | | | | | X |
| 7. Temperature Coefficient | ppm / °C | 200 (0.02% of Vo(rated)) / °C | | | | | | | | | | | X |
| 8. Up-Prog. Response Time, 0~Vomax, full-load | ms | 100 | | | | | | | 17 | | | | X |
| 9. Up-Prog. Response Time, 0~Vomax, no load | ms | 50 | | | | | | | 17 | | | | X |
| 10. Transient Response Time (CV mode); (*2), (*3) | ms | Less than 3 | | | | | | | Less than 1 | | | | X |
| 1.2 CONSTANT CURRENT MODE (CC) | | | | | | | | | | | | | |
| 1. Max. Line Reg (0.1% - Ior ≥ 333A; 0.050% - Ior < 333A) | mA | 50 | 38 | 30 | 25 | 19 | 15 | 13 | 28 | 23 | 18 | 15 | X |
| 2. Max. Load Reg (0.1% - Ior ≥ 333A; 0.075% - 25A ≤ Ior < 333A; 0.2% - Ior < 25A) | mA | 75 | 57 | 45 | 38 | 28 | 23 | 19 | 38 | 30 | 24 | 20 | X |
| 3. Output Ripple, rms (5Hz~1MHz), CC mode | mA | 50 | 20 | 20 | 20 | 10 | 10 | 10 | 15 | 10 | 6 | 4 | X |
| 4. Temperature Stability | --- | ± 0.05% of Io(rated) over 8 hours after 30 minute warm up (constant Line, Load & Temperature) | | | | | | | | | | | X |
| 5. Temperature Coefficient | ppm / °C | ± 300 (± 0.03% of Io(rated)) / °C | | | | | | | | | | | X |
| 1.3 PROTECTIVE FUNCTIONS | | | | | | | | | | | | | |
| 1. OCP | % | 0 ~ 100 | | | | | | | | | | | X |
| 2. OCP type | --- | Constant current | | | | | | | | | | | X |
| 3. Foldback Protection | --- | Output shut down; Manual reset by front panel OUT button or DIgital communication, user-selectable | | | | | | | | | | | X |
| 4. Foldback Response Time | s | Less than 1 (Min = 0.25 / Max = 25 / Default = 0.25); Settable via "FBD" command | | | | | | | | | | | X |
| 5. OVP type | --- | Inverter shut-down; Manual reset by On/Off recycle, OUT button, Remote Analog or Digital communication | | | | | | | | | | | X |
| 6. OVP Programming Accuracy | % | ± 5% of Vo(rated) | | | | | | | | | | | X |
| 7. OVP Trip Point | V | 5% to 105% of Vo(rated) - for Vor ≤ 600V; 10% to 105% of Vo(rated) - 600V < Vor ≤ 1500V Shall always be greater than 105% of Vo(setting); Default = 105% of Vo(rated) | | | | | | | | | | | X |
| 8. OVP response time | ms | Less than 10 (for Output to begin to drop) for Vor ≤ 600V Less than 2.0 (for Output to begin to drop) for 600V < Vor ≤ 1500V | | | | | | | | | | | X |
| 9. Max. OVP reset time | s | 7 (from AC On/Off switch turn On) | | | | | | | | | | | X |
| 10. Over temperature Protection | --- | Shut down if internal temperature exceeds safe operating levels (Latched: Safe / Unlatched: Auto) | | | | | | | | | | | X |
| 11. Phase Loss Protection | --- | Yes, power supply shutdown (Latched: Safe-Start / Unlatched: Auto-Restart) | | | | | | | | | | | X |
| 1.4 REMOTE ANALOG CONTROLS & SIGNALS | | | | | | | | | | | | | |
| 1. Vout Voltage Programming | | 0~100%, 0 ~ 5V or 0 ~ 10V, user-selectable, Accuracy & Linearity: ± 1% of Vo(rated) | | | | | | | | | | | X |
| 2. Iout Voltage Programming | | 0 ~ 100%, 0~5V or 0 ~ 10V, user-selectable, Accuracy & Linearity ± 1% of Io(rated) | | | | | | | | | | | X |
| 3. Vout resistor programming | | 0~100%, 0~5/10kohm full-scale, user-selectable, Accuracy & Linearity ± 1% of Vo(rated) | | | | | | | | | | | X |
| 4. Iout Resistor Programming | | 0~100%, 0~5/10kohm full-scale, user-selectable, Accuracy & Linearity ± 1% of Io(rated) | | | | | | | | | | | X |
| 5. Shut-Off (SO) Control (rear panel) | | By Voltage: 0.6V = DIS, 2-15V = ENA (default) or Dry Contact: Open = ENA, Short-DIS (user-selectable logic) | | | | | | | | | | | X |
| 6. Output Current Monitor | | 0 ~ 5V or 0 ~ 10V, Accuracy: ± 1% of Io(rated), user-selectable | | | | | | | | | | | X |
| 7. Output Voltage Monitor | | 0 ~ 5V or 0 ~ 10V, Accuracy: ± 1% of Vo(rated), user-selectable | | | | | | | | | | | X |
| 8. Power Supply OK (PS_OK) Signal | | Yes, TTL High = OK, 0V = Fail (500ohm series impedance) | | | | | | | | | | | X |
| 9. CV/CC Signal | | CV: TTL High (4 ~ 5V), Max source current = 10mA; CC: TTL Low (0 ~ 0.4V), Max sink current = 10mA | | | | | | | | | | | X |
| 10. Enable/Disable | | Dry contact; Open = OFF, Short = ON; Max. voltage across Enable/Disable contacts = 6V | | | | | | | | | | | X |
| 11. Remote/Local Selection | | Selects Remote or Local operation by voltage: 0 ~ 0.6V = Local / 2 - 15V = Remote | | | | | | | | | | | X |
| 12. Remote/Local Signal | | Signals operating mode; Open collector: Local = Open (Max voltage = 30V), Remote = On (Max sink current = 10mA) | | | | | | | | | | | X |
| 1.5 FRONT PANEL | | | | | | | | | | | | | |
| 1. Control Functions | | Vout/ Iout manual adjust by separate encoders (COARSE and FINE adjustment selectable) OVP/UVL manual adjust by VOLTAGE Adjust encoder, Front Panel Lock/Unlock Address selection by VOLTAGE Adjust encoder. # of Addresses = 31 AC ON/OFF, Output On/Off, Restart Modes (Auto/Safe), Foldback Control (CV to CC), Go-to-Local RS232/RS-485, LAN, IEEE (IEMD) and USB selection by rear panel DIP-switch Baud rate selection (RS-232/RS-485 only): 1200, 2400, 4800, 9600 and 19,200 (by CURRENT Adjust encoder) Advanced Parallel Master/Slave: Hx = Master unit, where x = # of Slave units (0 to 4); S = Slave unit(s) | | | | | | | | | | | X |
| 2. Display | | Voltage: 4 digits, Accuracy: ± 0.5% of Vo(rated) ± 1 count | | | | | | | | | | | X |
| | | Current: 4 digits, Accuracy: ± 0.5% of Io(rated) ± 1 count | | | | | | | | | | | X |
| | | VOLTAGE meter displays Voltage at power supply (Local sense) or at load (Remote sense) | | | | | | | | | | | X |
| 3. Indications | | Green LED's: PREVIEW, FOLD, REM./LOCAL, OUT ON/OFF, CV/CC, FINE Red LED's: ALARM (OVP, OTP, FOLD, AC FAIL, ENA, SO) | | | | | | | | | | | X |
| 1.6 DIGITAL PROGRAMMING & READBACK | | | | | | | | | | | | | |
| 1. Vout Programming Accuracy | | ± 0.5% of Vo(rated) | | | | | | | | | | | X |
| 2. Iout Programming Accuracy | | ± 0.5% of Io(rated) for units with Io < 187.5A; +/-0.7% of Io(rated) for Io ≥ 187.5A | | | | | | | | | | | X |
| 3. Vout Programming Resolution | | 0.02% of Vo(rated) | | | | | | | | | | | X |
| 4. Iout Programming Resolution | | 0.04% of Io(rated) | | | | | | | | | | | X |
| 5. Vout Readback Accuracy | | ± (0.1% of Vo(actual) + 0.2% of Vo(rated)) | | | | | | | | | | | X |
| 6. Iout Readback Accuracy | | ± (0.1% of Io(actual) + 0.4% of Io(rated)) | | | | | | | | | | | X |
| 7. Vout Readback Resolution | | 0.02% of Vo(rated) | | | | | | | | | | | X |
| 8. Iout Readback Resolution | | 0.02% of Io(rated) | | | | | | | | | | | X |
| 9. OV Response Time | | 20ms maximum (between Vout exceeding OVP Limit and supply inhibit turning On) | | | | | | | | | | | X |
| 10. Other Functions | | Set OVP/UVL limits, Set Local/Remote, Operating parameters and Status, Get Identity | | | | | | | | | | | X |

*1. Ripple and Noise at Vo(rated) and rated Load, Ta = 25C and nominal AC input, per EIJ R9002A.

*2. Time for the Output voltage to recover within 2% of rating for a load current change of 50~100% or 100-50% of rated Output.

*3. Operating with a load that continuously pulses the current (or voltage) can reduce the operating life of the Power Supply. Please contact TDK-Lambda Sales/Technical Support to discuss the application in detail.

All specifications subject to change without notice.

General Specifications, Genesys™ 3U 10kW/15kW

| 2.1 INPUT CHARACTERISTICS | | |
|---|------|--|
| 1. Input Voltage / Frequency (range) | --- | 208VAC (180-253), 400VAC (342-440 for $V_{out} \geq 30V$; 360-440 for $V_{out} < 30V$), 480VAC (432-528); 47-63Hz (all) |
| 2. No. of phases | --- | 3-Phase (Wye or Delta) 4 wire total (3 phases and 1 Protective Earth (PE) ground) |
| 3. Dropout Voltage | V | 180 / (342/360) / 432 |
| 4. Input Current (180VAC/342VAC or 360VAC/432VAC) | Arms | 10kW - 45/23/20 ($V_{out} \leq 600V$); 40/23/20 ($800V \leq V_{out} \leq 1500V$) - at full rated Output power 15kW - 64/32/27 ($V_{out} \leq 600V$); 55/32/27 ($800V \leq V_{out} \leq 1500V$) - at full rated Output power |
| 5. Inrush Current | A | Not to exceed full rated Input current (see 2.1.4 (Input Current)) |
| 6. Power Factor, passive (typical) | --- | $V_{out} < 600V$: 0.88 (passive), 10kW/15kW (208VAC, 400VAC, 480VAC) $V_{out} > 600V$: 0.90/0.93 - 10kW/15kW (208VAC), 0.89/0.92 - 10kW/15kW (400VAC), 0.84/0.88 - 10kW/15kW (480VAC) |
| 7. Leakage Current | mA | 3.5 maximum (EN60950) |
| 8. Input Protection | --- | Circuit breaker: 208VAC, ($V_{out} \leq 30V$); Line fuse: 208VAC ($V_{out} \geq 30V$) and 400VAC/480VAC (all models) |
| 10. Phase Imbalance | % | $\leq 5\%$ on three-phase Input |

| 2.2 POWER SUPPLY CONFIGURATION | |
|--------------------------------|--|
| 1. Parallel Operation; (*4) | Up to four (4) identical units may be connected in Master/Slave Mode with Single-Wire/Two-Wire connection. In "Advanced-Parallel", the current of Master unit multiplied by number of units connected in parallel is available via digital interface and displayed on the front panel display of the Master unit. Remote Analog current monitor of Master unit is scaled to the Output current of the Master unit (only) |
| 2. Series Operation (*4) | Possible (with external diodes); Up to two identical units with total Output voltage not to exceed $\pm 600V$ from Chassis ground (for $600V < V_{or} \leq 600V$) or not to exceed $\pm 1500V$ from Chassis ground (for $600V < V_{or} \leq 1500V$) |

| 2.3 ENVIRONMENTAL CONDITIONS | |
|------------------------------|--|
| 1. Operating Temperature | 0 to +50°C, 100% load |
| 2. Storage Temperature | -20 to +70°C |
| 3. Operating Humidity | 20 to 80% RH (non-condensing) |
| 4. Storage Humidity | 10 to 90% RH (non-condensing) |
| 5. Vibration & Shock | ASTM D4169, Standard Practice for Performance Testing of Shipping Containers and Systems, Shipping Unit: Single Package Assurance Level: Level II; Acceptance Criteria: Criterion 1 - No product damage Criterion 2 - Packaging is intact, Distribution Cycle: 12 - Air (intercity) and motor freight (local), unitized is used. |
| 6. Altitude | Operating: +50°C up to 6562ft (2000m), Derate Iout 2%/100m up to 3000m or 1°C/100m up to 3000m, Non-Operating 40,000ft (12,000m) |
| 7. Audible Noise | 70dBA at I _o (rated) (measured 1m from front panel) for $V_{out} < 30V$; 65dBA at I _o (rated) (measured 1m from front panel) for $V_{out} \geq 30V$ |

| 2.4 EMC | |
|-----------------------------------|--|
| 208VAC Input (all models) | |
| 1. ESD | EN61000-4-2 (IEC 801-2): Air-discharge $\pm 8kV$, Contact-discharge $\pm 4kV$ |
| 2. Fast Transients | EN61000-4-4 (IEC 1000-4-3); +/-2kV: AC Power, 2kV: DC Output |
| 3. Surge Immunity | EN61000-4-5 (IEC 1000-4-5); 1kV line-to-line, 2kV line-to-ground |
| 4. Conducted Immunity | EN61000-4-6 (IEC 1000-4-6); 10Vrms |
| 5. Radiated Immunity | EN61000-4-3 (IEC 1000-4-3); 10V/m |
| 6. Power Frequency Magnetic Field | EN61000-4-8; 30A/m |
| 7. Conducted Emissions | EN55011A, FCC part 15J-A |
| 8. Radiated Emissions | EN55011A, FCC part 15J-A |

| | |
|---|--|
| 400VAC (all models) /480VAC Input ($V_{out} \geq 20V$) | |
| 1. ESD | EN61000-4-2 (IEC 801-2): Air-discharge $\pm 8kV$, Contact-discharge $\pm 4kV$ |
| 2. Fast Transients | EN61000-4-4 (IEC 1000-4-3); +/-2kV: AC Power, 2kV: DC Output |
| 3. Surge Immunity | EN61000-4-5 (IEC 1000-4-5); 1kV line-to-line, 2kV line-to-ground |
| 4. Conducted Immunity | EN61000-4-6 (IEC 1000-4-6); 10Vrms |
| 5. Radiated Immunity | EN61000-4-3 (IEC 1000-4-3); 10V/m |
| 6. Power Frequency Magnetic Field | EN61000-4-8; 30A/m |
| 7. Voltage Dips, Short Interruptions and Voltage Variations Immunity Test (400VAC Only) | IEC 61000-4-11 |
| 8. Conducted Emissions | EN55011A, FCC part 15J-A |
| 9. Radiated Emissions | EN55011A, FCC part 15J-A |

| 2.5 SAFETY | |
|--|--|
| 1. Applicable Standards | IEC/EN/UL 61010-1, CSA 22.2 No. 61010-1 ($20V \leq V_{out} \leq 1500V$); UL/cUL 60950-1, EN60950-1 recognized, CB Scheme ($V_{out} < 20V$) 7.5V $\leq V_{out} \leq 400V$: Output is Hazardous; LAN/IEEE/USB/Isolated Analog are SELV 400V $< V_{out} \leq 600V$: Output is Hazardous; LAN/IEEE/USB/Isolated Analog are not SELV 600V $< V_{out} \leq 1500V$: Output is Hazardous; LAN/IEEE/USB/Isolated Analog are SELV |
| 2. Withstand Voltage: (208VAC/400VAC/480VAC; for 60 seconds); (*5) | $V_{out} < 80V$: Input - Ground: 2200VDC/2900VDC/2900VDC, Input-Hazardous Output: 2200VDC/3100VDC/3100VDC, Input - SELV: 2200VDC/2900VDC/2900VDC; Hazardous Output - SELV: 900VDC/900VDC/900VDC, Hazardous Output - Ground: 900VDC/900VDC/900VDC. $80V \leq V_{out} \leq 300V$: Input - Ground: 2200VDC/2900VDC/2900VDC, Input-Hazardous Output: 2200VDC/3500VDC/3500VDC, Input - SELV: 2200VDC/2900VDC/2900VDC; Hazardous Output - SELV: 900VDC/900VDC/900VDC, Hazardous Output - Ground: 900VDC/900VDC/900VDC. $300 < V_{out} \leq 600V$ models: Input-Ground: 2200VDC/2900VDC/2900VDC, Input-Hazardous Output: 3300VDC/3900VDC/3900VDC, Input-SELV: 2200VDC/2900VDC/2900VDC, Hazardous Output - SELV: 900VDC/900VDC/900VDC, Hazardous Output - Ground: 900VDC/900VDC/900VDC $600 < V_{out} \leq 1500V$ models: Input-Ground: 2200VDC/2900VDC/2900VDC, Input-Hazardous Output: 4500VDC/5040VDC/5040VDC, Input-SELV: 2900VDC/2900VDC/2900VDC, Hazardous Output - SELV: 2500VDC/2500VDC/2500VDC, Hazardous Output - Ground: 2500VDC/2500VDC/2500VDC |
| 3. Insulation Resistance | 20Megohms (typical) at 500VDC, $T_a = +25^\circ C$, RH = 70% |

| 2.6 MECHANICAL CONSTRUCTION | |
|---|--|
| 1. Cooling | Fan-driven with airflow from front to rear. Fan-speed control on models with $V_{out} \geq 20V$ "Zero Stackable" top and bottom. Vents on side shall not be blocked. Chassis slides or suitable rear support required. EIA rack mounting |
| 2. Dimensions (W x H x D) | Width: 429mm / 16.9"; Height: 3U - 133mm / 5.22" Depth: 564mm / 22.2" for $V_{out} < 600V$, 581mm / 22.9" for $800V \leq V_{out} \leq 1500V$; excluding connectors, encoders, handles, etc. |
| 3. Weight | 43kg / 97 lbs ($V_{out} \leq 600V$); 32kg / 70lbs ($V_{out} > 600V$) |
| 4. AC Input connector (with Protective Cover) | M6 x 1" (25.4mm) threaded studs (L1, L2, L3 and Chassis GND) and terminal cover. |
| 5. Output Connectors (busbar) | Busbars: $V_{out} < 20V$: (two-hole busbars); $20V \leq V_{out} \leq 300V$: busbars (one hole busbars) Threaded-stud terminals: $400V \leq V_{out} \leq 600V$: M6 x 0.5" (12.7mm) threaded-stud; $800V \leq V_{out} \leq 1500V$: M6 x 1.0" (25.4mm) threaded-stud |
| 6. Control Connectors | Analog Programming: DB25, plastic connector, AMP747461-5, Female on Supply; Male on Mating connector, 747321, 25 pin Sub-D connector. |
| 7. Mounting Method | Standard 19" Rack-Mount, provision for standard chassis slides. Side/Rear Support is required; Do not mount by front panel only |
| 8. Output Ground Connection | M5 x 0.91" (23mm) threaded-stud |

| 2.7 WARRANTY | |
|--------------|---------|
| 1. Warranty | 5 years |

*4. Please contact TDK-Lambda Sales/Technical Support to discuss your Parallel or Series application in more detail.

*5 Please contact TDK-Lambda Sales/Technical Support to discuss your System-Level Withstand Voltage requirements in more detail.

All specifications subject to change without notice.



Genesys™ Power Parallel and Series Configurations

Parallel Operation - Master/Slave^(*)

Active current sharing allows up to four identical units to be connected in an Auto-parallel configuration for the Output power. In Advanced Parallel Master/Slave Mode, total current is programmed and reported by the Master, Up to four 10kW/15kW Power Supplies in parallel act as one 40kW/60kW Power Supply.



Series Operation^(*)

Up to two units may be connected in series to increase the Output voltage or to provide bipolar output. (Max 600V to Chassis GND for $V_{or} \leq 600V$; Max 1500V to Chassis GND for $600V < V_{or} \leq 1500V$).

Remote Programming via RS-232 & RS-485 Interface

Standard Serial Interface allows daisy-chain control of up to 31 power supplies on the same communication bus with built-in RS-232 & RS-485 Interface or optional LAN, USB or IEEE Interface.



RS-232, RS-485
LAN, IEEE or USB

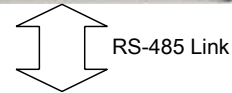
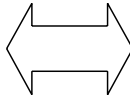

Programming Options (Factory installed)

Standard RS-232/RS-485 (Multi-Drop) Interface

- Standard Units are equipped with the RS-485 Multi-Drop function
- Allows RS-232 or RS-485 Master unit to control up to 30 (standard) Slave units using RS-485 daisy-chain link

P/N: "-----"

LAN Interface (LXI 1.5 Compliant w/ Multi-Drop)

- Meets all LXI 1.5 Requirements
- Address Viewable on Front Panel
- Fixed and Dynamic Addressing
- Fast Startup
- VISA & SCPI Compatible
- LAN Fault Indicators
- Auto-detects LAN Cross-over Cable
- Compatible with most standard Networks

P/N: LAN (for all models)

IEEE (Multi-Drop) Interface

- IEEE 488.2 & SCPI compliant
- Allows IEEE Master to control up to 30 (standard) Slave units using RS-485 daisy-chain
- Program/Measure Voltage
- Over-Voltage setting and shutdown
- Error and Status Messages
- Program/Measure Current
- Current Foldback shutdown

P/N: IEMD (for all models)

USB (Multi-Drop) Interface

- USB 2.0 compliant
- Allows serial connection to computer USB port
- Allows USB Master to control up to 30 (standard) Slaves using RS-485 daisy-chain
- Uses same command set as standard RS-232/RS-485 interface

P/N: USB (for all models)

Isolated Analog Programming

- Option for models with $V_{out} \leq 600V$ (IS510 & IS420); IS510 built-in for models where $800V \leq V_{out} \leq 1500V$
- Four Channels total (Two channels to Program Voltage and Current; Two channels to Monitor Voltage and Current)
- Isolation allows operation with floating references in harsh electrical environments
- Choose between programming with Voltage or Current
- Connection via removable terminal block: Phoenix MC1,5/8-ST-3.81

- Voltage Programming, User-selectable 0-5V or 0-10V signal
 - Power supply Voltage and Current Programming Accuracy: $\pm 1.0\%$
 - Power supply Voltage and Current Monitoring Accuracy: $\pm 1.5\%$

P/N: IS510 (for $V_{out} \leq 600V$)

- Current Programming with 4-20mA signal
 - Power supply Voltage and Current Programming Accuracy: $\pm 1.0\%$
 - Power supply Voltage and Current Monitoring Accuracy: $\pm 1.5\%$

P/N: IS420 (for all models)

Outline Drawing: Genesys™ 10kW (7.5V to 12.5V - 208VAC/400VAC/480VAC)

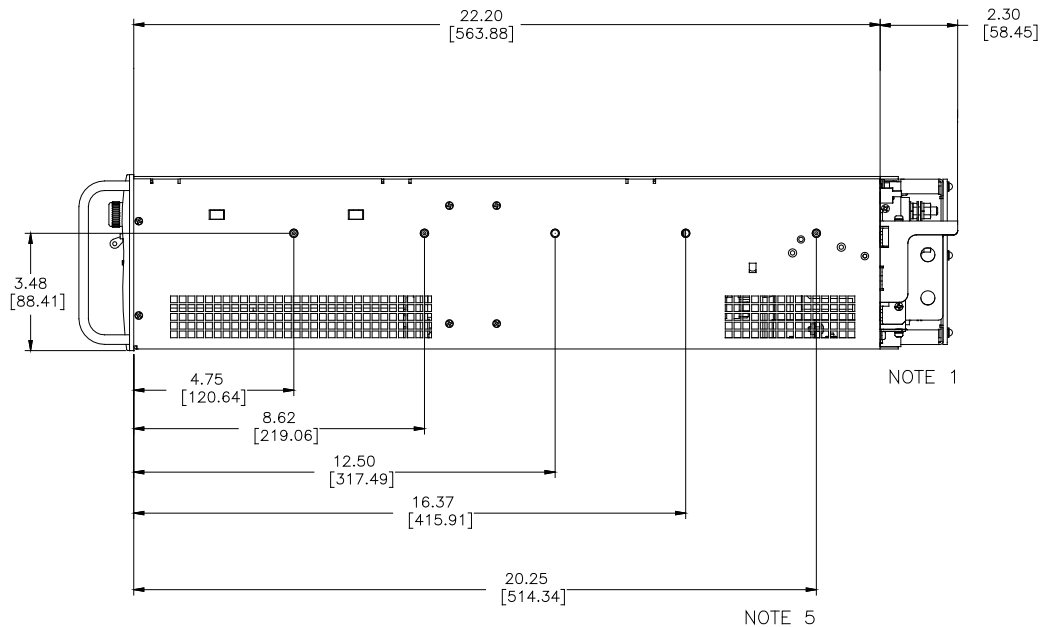
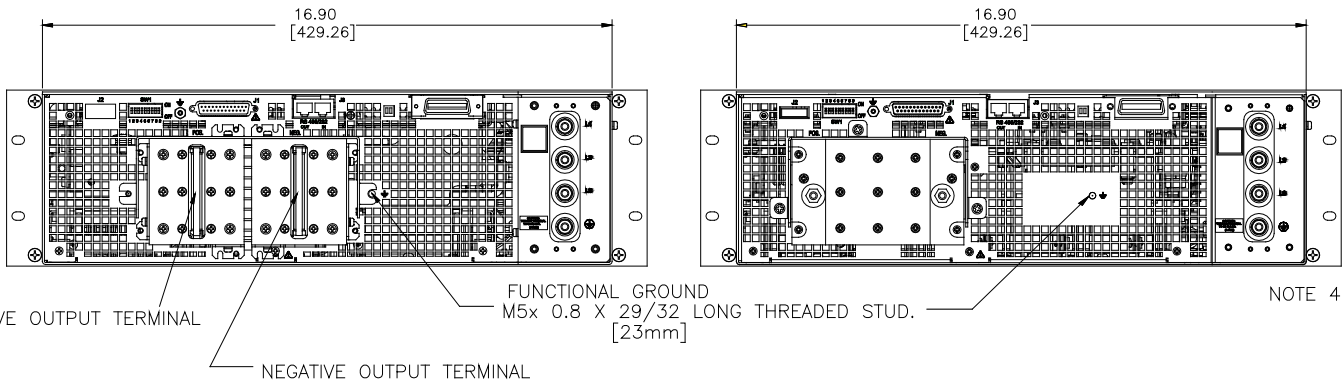
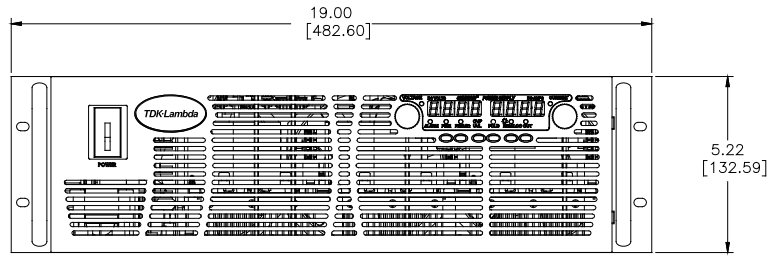

NOTES:

1. Busbars for models where $V_{out} < 20V$ Output: two holes 0.42" (10.72mm) diameter.
2. N/A
3. N/A
4. Input Terminals: M6 x 1" (Qty = 3); Ground Terminal: M5 x 1" (Qty = 2)
5. Mounting for Slide Mounts (not included).

Recommend: General Devices, Chassis Trak P/N C230-S-122; Verify requirements with slide manufacturer.
Secure with pan head screw: M5 x 0.8-8mm long (max).

Outline Drawing: Genesys™ 10kW/15kW (20V to 300V - 208VAC/400VAC/480VAC)

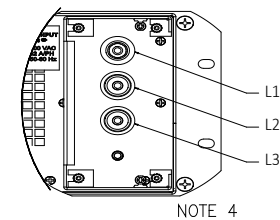
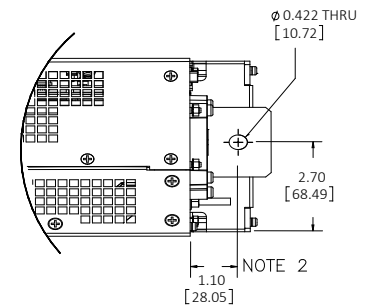
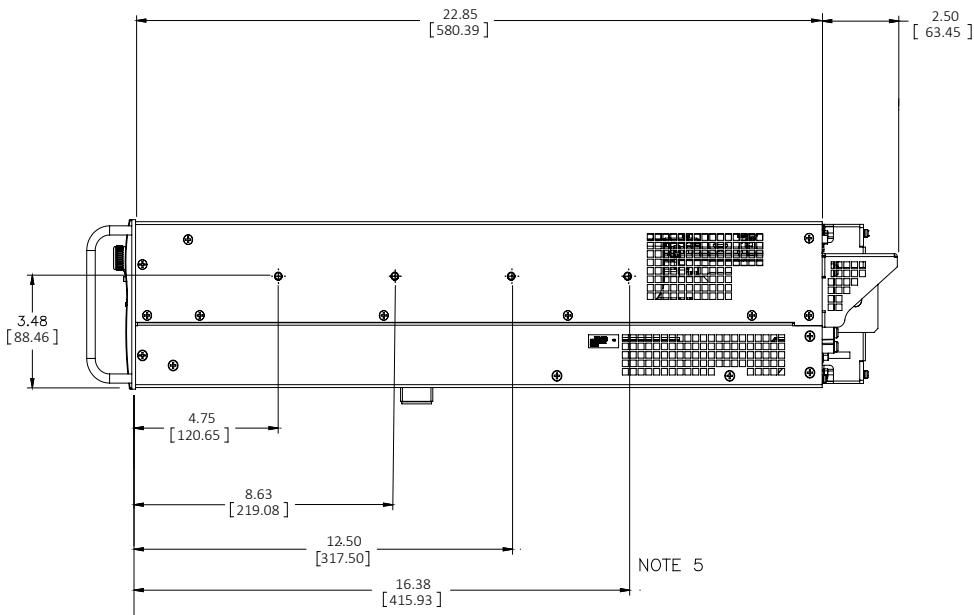
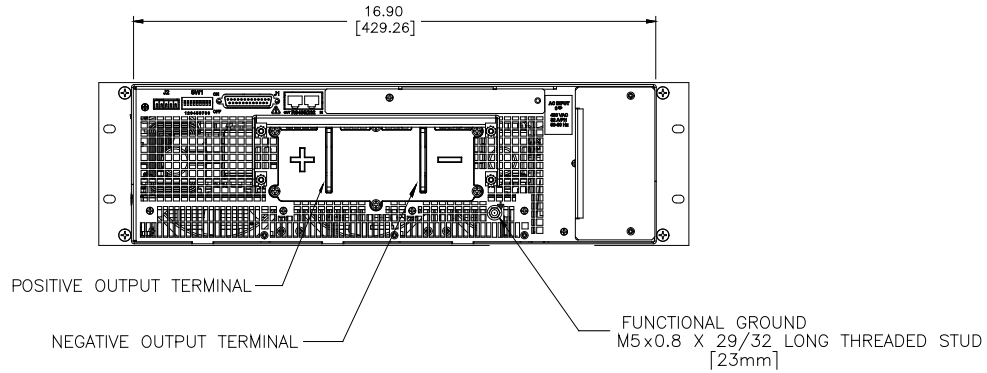
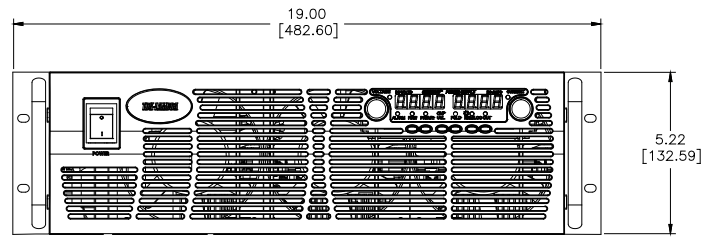

NOTES:

1. N/A
2. Bus bars for models $20V \leq V_{out} \leq 300V$ (10kW/15kW): one hole 0.42" (10.72mm) diameter.
3. N/A
4. Input Terminals: M6 x 1" (Qty = 3) + Ground M5 x 1" (Qty = 2)
5. Mounting for Slide Mounts (not included).
Recommend General Devices, Chassis Trak P/N C230-S-122; Verify requirements with slide manufacturer.
Secure with pan head screw: M5 x 0.8-8mm long (max).

Outline Drawing: Genesys™ 10kW/15kW (400V to 600V - 208VAC/400VAC/480VAC)

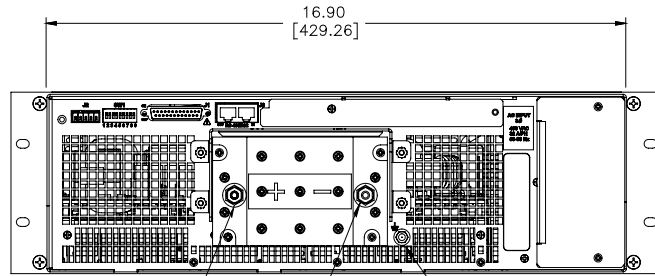
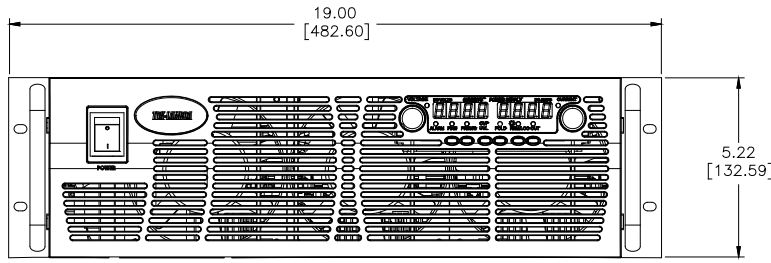

POSITIVE OUTPUT TERMINAL

NEGATIVE OUTPUT TERMINAL

FUNCTIONAL GROUND
M5x0.8 X 29/32 LONG THREADED STUD
[23mm]

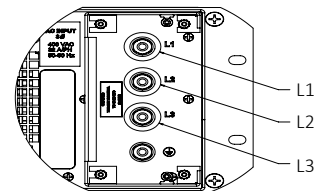
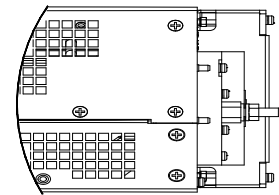
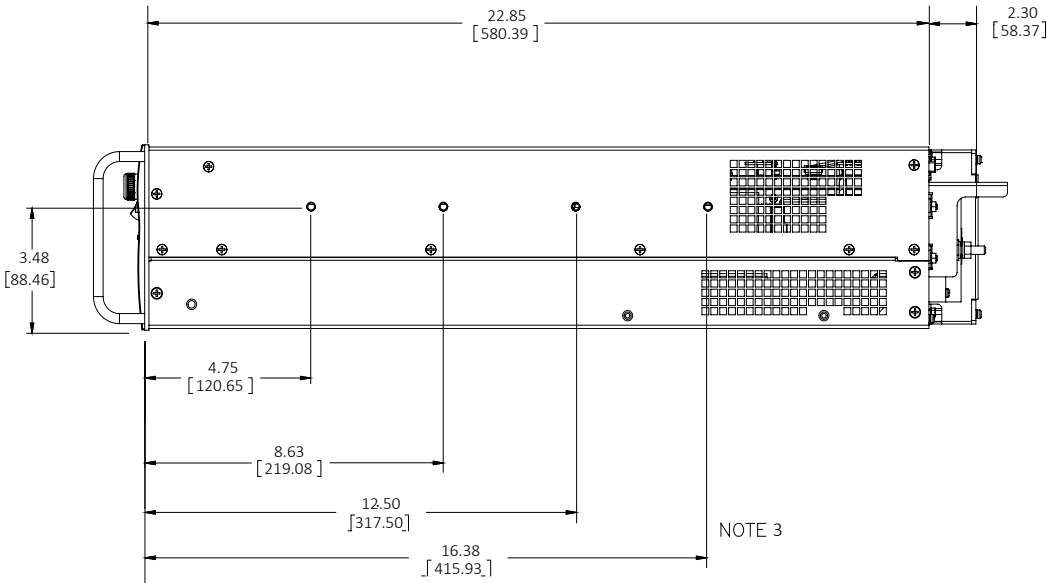

NOTES:

1. N/A

2. N/A

3. Threaded-stud terminals for models with $400V \leq V_{out} \leq 600V$ (M5 x 1").

4. Input Terminals M6 x 1" (Qty = 3) + Ground M5 x 1" (Qty = 2)

5. Mounting for Slide Mounts (not included).

Recommend General Devices, Chassis Trak P/N C230-S-122; Verify requirements with slide manufacturer.

Secure with pan head screw: M5 x 0.8-8mm long (max).

Outline Drawing: Genesys™ 10kW/15kW (800V to 1500V - 208VAC/400VAC/480VAC)

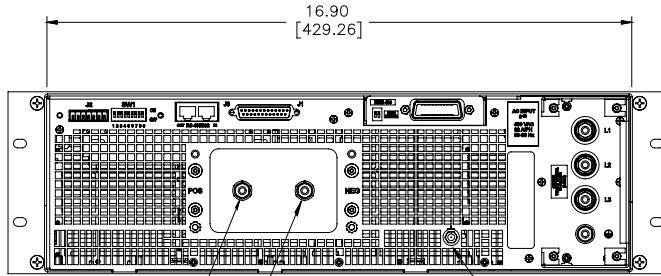
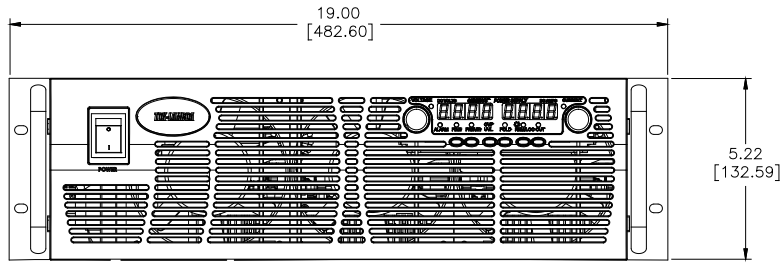

POSITIVE OUTPUT TERMINAL

NEGATIVE OUTPUT TERMINAL

FUNCTIONAL GROUND
M5x0.8 X 29/32 LONG THREADED STUD
[23mm]

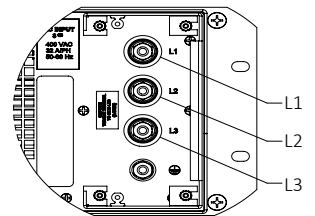
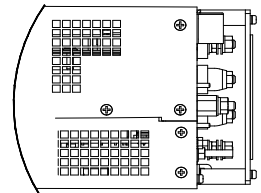
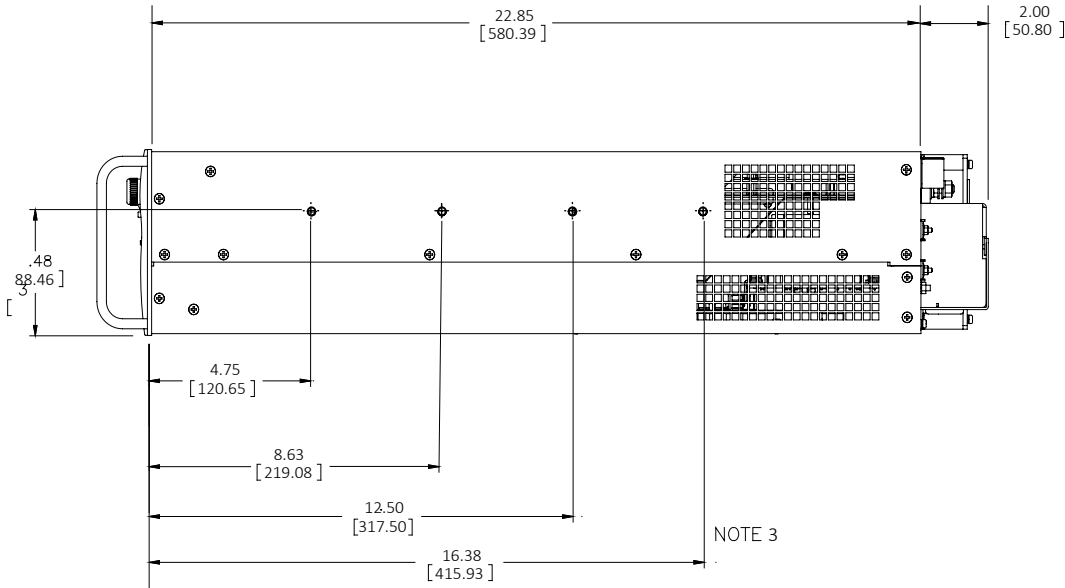

NOTES:

1. N/A
2. N/A
3. Threaded stud terminals for models with $800V \leq V_{out} \leq 1500V$ Output (M5 x 1").
4. Input Terminals M6 x 1" (Qty = 3) + Ground M5 x 1" (Qty = 2)
5. Mounting for Slide Mounts (not included).
Recommend General Devices, Chassis Trak P/N C230-S-122; Verify requirements with slide manufacturer.

Secure with pan head screw M5 x 0.8-8mm long (max).

Power Supply Identification / Accessories (Genesys™ 3U 10kW/15kW)

How to Order:

GEN **10** - **1000** - **LAN** - **3P208**
 Series Output Output
 Name Voltage Current
 (0~10V) (0~1000A)
 Factory Options
 Option: "-----"
 LAN
 IEMD
 USB
 IS510
 IS420
 AC Input Options
 3P208 (Three-Phase 208VAC)
 3P400 (Three-Phase 400VAC)
 3P480 (Three-Phase 480VAC)

| Model | Output Voltage (Vdc) | Output Current (A dc) | Output Power (kW) |
|--------------|----------------------|-----------------------|-------------------|
| GEN 7.5-1000 | 0~7.5 | 0~1000 | 7.5 |
| GEN 10-1000 | 0~10 | 0~1000 | 10 |
| GEN 12.5-800 | 0~12.5 | 0~800 | 10 |
| GEN 20-500 | 0~20 | 0~500 | 10 |
| GEN 25-400 | 0~25 | 0~400 | 10 |
| GEN 30-333 | 0~30 | 0~333 | 10 |
| GEN 30-500 | | 0~500 | 15 |
| GEN 40-250 | 0~40 | 0~250 | 10 |
| GEN 40-375 | | 0~375 | 15 |
| GEN 50-200 | 0~50 | 0~200 | 10 |
| GEN 50-300 | | 0~300 | 15 |
| GEN 60-167 | 0~60 | 0~167 | 10 |
| GEN 60-250 | | 0~250 | 15 |
| GEN 80-125 | 0~80 | 0~125 | 10 |
| GEN 80-187.5 | | 0~187.5 | 15 |
| GEN 100-100 | 0~100 | 0~100 | 10 |
| GEN 100-150 | | 0~150 | 15 |
| GEN 125-80 | 0~125 | 0~80 | 10 |
| GEN 125-120 | | 0~120 | 15 |
| GEN 150-66 | 0~150 | 0~66 | 10 |
| GEN 150-100 | | 0~100 | 15 |

| Model | Output Voltage (Vdc) | Output Current (A dc) | Output Power (kW) |
|---------------|----------------------|-----------------------|-------------------|
| GEN 200-50 | 0~200 | 0~50 | 10 |
| GEN 200-75 | | 0~75 | 15 |
| GEN 250-40 | 0~250 | 0~40 | 10 |
| GEN 250-60 | | 0~60 | 15 |
| GEN 300-33 | 0~300 | 0~33 | 10 |
| GEN 300-50 | | 0~50 | 15 |
| GEN 400-25 | 0~400 | 0~25 | 10 |
| GEN 400-37.5 | | 0~37.5 | 15 |
| GEN 500-20 | 0~500 | 0~20 | 10 |
| GEN 500-30 | | 0~30 | 15 |
| GEN 600-17 | 0~600 | 0~17 | 10 |
| GEN 600-25 | | 0~25 | 15 |
| *GEN 800-12.5 | 0~800 | 0~12.5 | 10 |
| *GEN 800-18.8 | | 0~18.8 | 15 |
| *GEN 1000-10 | 0~1000 | 0~10 | 10 |
| *GEN 1000-15 | | 0~15 | 15 |
| *GEN 1250-8 | 0~1250 | 0~8 | 10 |
| *GEN 1250-12 | | 0~12 | 15 |
| *GEN 1500-6.7 | 0~1500 | 0~6.7 | 10 |
| *GEN 1500-10 | | 0~10 | 15 |

Factory options

RS-232/RS-485 Multi-Drop Interface (built-in standard)
 LAN Interface (LXI 1.5 compliant w/ Multi-Drop)
 GPIB (488.2 w/ Multi-Drop) Interface
 USB (2.0 w/ Multi-Drop) Interface
 Isolated Analog Interface (Voltage Program/Monitor)
 Isolated Analog Interface (Current Program/Monitor)

P/N

"-----"
 LAN
 IEMD
 USB
 IS510 *(built-in standard on 800V-1500V models)
 IS420

Accessories

1. Serial Communication cable (optional)

RS-232/RS-485 cable is used to connect the power supply to the Host PC.

| Mode | RS-485 | RS-232 | RS-232 |
|------------------------|----------------------|----------------------|----------------------|
| PC Connector | DB-9F | DB-9F | DB-25F |
| Communication Cable | Shield Ground, L=2m | Shield Ground, L=2m | Shield Ground, L=2m |
| Power Supply Connector | EIA/TIA-568A (RJ-45) | EIA/TIA-568A (RJ-45) | EIA/TIA-568A (RJ-45) |
| P/N | GEN/485-9 | GEN/232-9 | GEN/232-25 |

2. Serial Link cable (optional)

Daisy-chain up to 31 Genesys™ power supplies.

| Mode | Power Supply Connector | Communication Cable | P/N |
|--------|------------------------|-----------------------|----------|
| RS-485 | EIA/TIA-568A (RJ-45) | Shield Ground, L=50cm | GEN/RJ45 |

Genesys™ Family - Output Voltage / Output Current

| Model | GENH | GEN-1U | | | GEN-2U | | GEN 3U | |
|----------------|----------------------|------------|------------|-------------|-------------|-------------|------------------------|---|
| Rated Power | 750W | 750W | 1.5kW | 2.4kW | 3.3kW | 5.0kW | 10kW | 15kW |
| Voltage Range | Output Current Range | | | | | | | |
| 0~6V | 0~100A | 0~100A | 0~200A | | | | | |
| 0~7.5V | | | | | | | 0~1000A | |
| 0~8V | 0~90A | 0~90A | 0~180A | 0~300A | 0~400A | 0~600A | | |
| 0~10V | | | | 0~240A | 0~330A | 0~500A | 0~1000A | |
| 0~12.5V | 0~60A | 0~60A | 0~120A | | | | 0~800A | |
| 0~15V | | | | | 0~220A | | | |
| 0~16V | | | | 0~150A | | 0~310A | | |
| 0~20V | 0~38A | 0~38A | 0~76A | 0~120A | 0~165A | 0~250A | 0~500A | |
| 0~25V | | | | | | | 0~400A | |
| 0~30V | 0~25A | 0~25A | 0~50A | 0~80A | 0~110A | 0~170A | 0~333A | 0~500A |
| 0~40V | 0~19A | 0~19A | 0~38A | 0~60A | 0~85A | 0~125A | 0~250A | 0~375A |
| 0~50V | | | 0~30A | | | | 0~200A | 0~300A |
| 0~60V | 0~12.5 | 0~12.5A | 0~25A | 0~40A | 0~55A | 0~85A | 0~167A | 0~250A |
| 0~80V | 0~9.5A | 0~9.5A | 0~19A | 0~30A | 0~42A | 0~65A | 0~125A | 0~187.5A |
| 0~100V | 0~7.5A | 0~7.5A | 0~15A | 0~24A | 0~33A | 0~50A | 0~100A | 0~150A |
| 0~125V | | | | | | | 0~80A | 0~120A |
| 0~150V | 0~5A | 0~5A | 0~10A | 0~16A | 0~22A | 0~34A | 0~66A | 0~100A |
| 0~200V | | | | | 0~16.5A | 0~25A | 0~50A | 0~75A |
| 0~250V | | | | | | | 0~40A | 0~60A |
| 0~300V | 0~2.5A | 0~2.5A | 0~5A | 0~8A | 0~11A | 0~17A | 0~33A | 0~50A |
| 0~400V | | | | | | 0~12.5A | 0~25A | 0~37.5A |
| 0~500V | | | | | | 0~10A | 0~20A | 0~30A |
| 0~600V | 0~1.3A | 0~1.3A | 0~2.6A | 0~4A | 0~5.5A | 0~8.5A | 0~17A | 0~25A |
| 0~800V | | | | | | | 0~12.5A ⁽⁵⁾ | 0~18.8A ⁽⁵⁾ |
| 0~1000V | | | | | | | 0~10A ⁽⁵⁾ | 0~15A ⁽⁵⁾ |
| 0~1250V | | | | | | | 0~8A ⁽⁵⁾ | 0~12A ⁽⁵⁾ |
| 0~1500V | | | | | | | 0~6.7A ⁽⁵⁾ | 0~10A ⁽⁵⁾ |
| Weight (kg/lb) | 4.5 / 9.9 | 7.0 / 15.0 | 8.5 / 18.0 | 10.0 / 22.0 | 13.0 / 29.0 | 16.0 / 35.0 | 43.0 / 97.0 | 43.0 / 97.0 32.0 / 70.0 ⁽⁶⁾ |

(6) 800V - 1500V models only (10kW/15kW)

AC Inputs

| | | | | | | | | |
|---------------|-------|-------|-------|-------|-------|-------|------------|------------|
| 85-265Vac, 1Ø | • (1) | • (1) | • (1) | | | | | |
| 230Vac, 1Ø | | | | • (1) | • (1) | | | |
| 208Vac, 3Ø | | | | • (1) | • (1) | • (1) | • (3) | • (3) |
| 400Vac, 3Ø | | | | | • (1) | • (1) | • (3) | • (3) |
| 480Vac, 3Ø | | | | | • (2) | • (2) | • (3), (4) | • (3), (4) |

(1) UL/IEC/EN/CSA22.2 No. 61010-1; CE Mark; (2) UL/IEC/EN/CSA22.2 No. 61010-1, RoHS; (3) UL/IEC/EN/CSA22.2 No. 61010-1, CE Mark - (Vout ≥ 20V);
4) UL/cUL/EN 60950-1 Recognized, RoHS - (Vout < 20V)

Options (All Models)

| | |
|---------|---|
| “-----” | Standard RS-232/RS-485 Master with RS-485 Multi-Drop capability installed |
| LAN | LXI 1.5 Compliant LAN Interface with RS-485 Multi-Drop capability installed |
| IEMD | IEEE Master (IEEE 488.2 & SCPI compliant) with RS-485 Multi-Drop capability installed |
| USB | USB (2.0) Master with RS-485 Multi-Drop capability installed |
| IS510 | Isolated Analog Program/Monitor (0-5V or 0-10V, user-selectable) for 6V-600V models; *(5) |
| IS420 | Isolated Analog Program/Monitor (4-20mA) |

All “Options” are factory installed and limited to one “option” per power supply
*(5) Isolated 5V/10V (IS510) Interface is built-in standard for 800V-1500V models
All specifications are subject to change without notice

USA

TDK-Lambda Americas Inc.
405 Essex Rd. Neptune, NJ 07753
Tel: +1-732-795-4100 Fax: +1-732-922-9334
E-Mail: sales@us.tdk-lambda.com
Web: www.us.tdk-lambda.com/hp

CANADA

ACA TMetrix
3835 Laird Road, Mississauga, Ontario, L5L 5Y4
Tel: +1-800-665-7301 Fax: +1-905-890-1959
E-Mail: lambda@aca.ca
Web: tmetrix.com

MEXICO

AcMax de Mexico
39 Poniente 3515 Piso 5 Col. Las Animas
Puebla, Pue. C.P. 72400
Tel: 01-800-211-0060 / (222) 891-8484 Fax: 222-264-1445
E-Mail: info@acmax.mx, Web: www.acmax.mx

BRAZIL

Suplítec
Rua Sena Madureira 465
31340-000 Belo Hte - MG-Brazil
Tel: +55-31-3498-1177
E-Mail: vendas@suplítec.com.br, Web: www.suplítec.com.br

UK

TDK-Lambda UK Ltd.
Kingsley Avenue
Ilfracombe, Devon 34 8ES, United Kingdom
Tel: +44-1271-856666 Fax: +44-1271-864894
E-Mail: powersolutions@uk.tdk-lambda.com
Web: www.uk.tdk-lambda.com

IRELAND

FRANCE

TDK-Lambda France SAS
3 Avenue du Canada, Parc Technopolis - Batiment Sigma
91940 Les Ulis - France CS 41077
Tel: +33 1 60 12 71 65 Fax: +33 1 60 12 71 66
E-Mail: france@fr.tdk-lambda.com, Web: www.fr.tdk-lambda.com

NETHERLANDS

SPAIN

GERMANY

TDK-Lambda Germany GmbH
Karl-Bold-Strasse 40
D-77855 Achern, Germany
Tel: +49-7841-666-0 Fax: +49-7841-500-0
E-Mail: info.germany@de.tdk-lambda.com
Web: www.de.tdk-lambda.com

AUSTRIA

SWITZERLAND

ITALY

TDK-Lambda Italy
France Sas Succursale Italiana
Via dei Lavoratori 128/130
IT 20092 Cinisello Balsamo, Milano, Italy
Tel: +39-02-6129-3863 Fax: +39-02-6129-0900
E-Mail: info.italia@it.tdk-lambda.com
Web: www.it.tdk-lambda.com

SCANDINAVIA

BALTICS

TDK-Lambda Germany GmbH
Karl-Bold-Strasse 40
D-77855 Achern, Germany
Tel: +49-7841-666-0 Fax: +49-7841-500-0
E-Mail: info.germany@de.tdk-lambda.com
Web: www.de.tdk-lambda.com

JAPAN

TDK-Lambda Corporation
International Sales Division,
3-9-1, Shibaura, Minato-ku,
Tokyo 108-0023, Japan
Tel: +81-3-6852-7125 Fax: +81-3-6852-7140
Web: www.jp.tdk-lambda.com

CHINA

Wuxi TDK-Lambda Electronics Co. Ltd, Shanghai Office
5th Floor Kehui Tower, 1188 Qinzhou Road (North)
Xuhui District Shanghai, 200233 P.R. CHINA
Tel: +86-21-6485-0777 Fax: +86-21-6485-0666
Web: www.cn.tdk-lambda.com

Beijing Branch of Wuxi TDK-Lambda Electronics Co. Ltd.
Room 12B11-12B12, Unit 7 Dacheng Square, No. 28
Xuanwumenxi Street, Xuanwu District Beijing, 100053, P.R. CHINA
Tel: +86-10-6310-4872 Fax: +86-10-6310-4874
Web: www.cn.tdk-lambda.com

Shenzen Branch of Wuxi TDK-Lambda Electronics Co. Ltd.
69/F, Ping An Finance Center, 5033 Yitian Road
Futian District, Shenzhen, P. R. CHINA
Tel: +86-755-83588261 Fax: +86-755-83588260
Web: www.cn.tdk-lambda.com

KOREA

TDK-Lambda Corporation Korea Branch
(Seocho-Dong, 8F, Songnam Bldg.) 273, Gangnam-Daero,
Seochu-Gu. Seoul 137-862, Republic of Korea 137-862
Tel: +82-2-3473-7051 Fax: +82-2-3472-9137
www.tdk-lambda.co.kr

MALAYSIA

TDK-Lambda Malaysia Sdn. Bhd.
c/o TDK (Malaysia) Sdn Bhd.,
Lot 709, Nilai Industrial Estate 71800 Nilai
Negeri Sembilan, Malaysia
Tel: +60-6-799-1130 Fax: +60-6-799-3277
Web: www.my.tdk-lambda.com

SINGAPORE

TDK-Lambda Singapore Pte. Ltd.
1008 Toa Payoh North # 06-01/08, #07-01/03
Singapore 318996
Tel: +65-6251-7211 Fax: +65-6250-9171
Web: www.sg.tdk-lambda.com

PHILIPPINES

THAILAND

INDIA

TDK-Lambda Singapore Pte. Ltd. (India Branch)
No.989, 1st Cross, 2nd Floor, 13th Main,
HAL 2nd Stage, Bangalore, Karnataka, India-560 008
Tel : +91-80-43550 500 Fax :+91-80-43550 501
E-Mail: mathew.philip@in.tdk-lambda.com Web: www.in.tdk-lambda.com

ISRAEL

TDK-Lambda Ltd. Israel
Kibbutz Givat Hashlosa Tel-Aviv 48800, Israel
Tel: +972-3-9024-333 Fax: +972-3-9024-777
E-Mail: info@tdk-lambda.co.il
Web: www.tdk-lambda.co.il

RUSSIA

