

Arbitrary Function Generator

AFG-4000 Series

User Manual

GW INSTEK PART NO.



ISO-9001 CERTIFIED MANUFACTURER

GW INSTEK

This manual contains proprietary information, which is protected by copyright. All rights are reserved. No part of this manual may be photocopied, reproduced or translated to another language without prior written consent of Good Will company.

The information in this manual was correct at the time of printing. However, Good Will continues to improve products and reserves the rights to change specification, equipment, and maintenance procedures at any time without notice.

Table of Contents

SAFETY INSTRUCTIONS	4
Safety Precaution before Operation	8
Electro-static Discharge (ESD) Protection	11
First Time to Power on	12
GETTING STARTED	13
Main Features	16
Appearance	18
Boot Up	24
User Interface	25
Product Operation	28
Remote Control	85
SPECIFICATIONS	88
Specifications	88
Build-in wave list	106
Certificate Of Compliance	110
APPENDIX	111
Appendix A: Attachments	111
Appendix B: Care and Cleaning Maintenance	111
Appendix C: Troubleshooting	113
Certificate Of Compliance	114

S SAFETY INSTRUCTIONS

This chapter contains important safety instructions that you must follow during operation and storage. Read the following before any operation to insure your safety and to keep the instrument in the best possible condition.

Safety Symbols

These safety symbols may appear in this manual or on the instrument.



WARNING

Warning: Identifies conditions or practices that could result in injury or loss of life.



CAUTION

Caution: Identifies conditions or practices that could result in damage to the AFG-4000 or to other properties.



DANGER High Voltage



Attention Refer to the Manual



Protective Conductor Terminal



Earth (ground) Terminal



Do not dispose electronic equipment as unsorted municipal waste. Please use a separate collection facility or contact the supplier from which this instrument was purchased.

Safety Guidelines

General Guideline • Do not place any heavy object on the AFG-4000.



CAUTION

- Avoid severe impact or rough handling that may damaging the AFG-4000.
- Avoid discharges of static electricity on or near the AFG-4000.
- Do not block the cooling fan opening.
- Use only mating connectors, not bare wires, for the terminals.
- The instrument should only be disassembled by a qualified technician..

(Measurement categories) EN 61010 specifies the measurement categories and their requirements as follows. The AFG-4000 falls under category I.

- Measurement category IV is for measurement performed at the source of a low-voltage installation.
- Measurement category III is for measurement performed in a building installation.
- Measurement category II is for measurement performed on circuits directly connected to a low voltage installation.
- Measurement category I is for measurements performed on circuits not directly connected to Mains.

Power Supply



WARNING

- AC Input voltage rating: 100Vac-240Vac (+/- 10%)
 - Frequency: 50Hz/60Hz
 - Connect the protective grounding conductor of the AC power cord to an earth ground to prevent electric shock..
-

Fuse



WARNING

- Fuse type: F2A/250V.
 - Only qualified technicians should replace the fuse.
 - To ensure fire protection, replace the fuse only with the specified type and rating.
 - Disconnect the power cord and all test leads before replacing the fuse.
 - Make sure the cause of fuse blowout is fixed before replacing the fuse.
-

Cleaning the
AFG-4000

- Disconnect the power cord before cleaning the AFG-4000.
 - Use a soft cloth dampened in a solution of mild detergent and water. Do not spray any liquid into the AFG-4000.
 - Do not use chemicals containing harsh material such as benzene, toluene, xylene, and acetone.
-

Operation
Environment

- Location: Indoor, no direct sunlight, dust free, almost non-conductive pollution (Note below)
- Relative Humidity: <80%
- Altitude: < 2000m
- Temperature: 0°C to 40°C

(Pollution Degree) EN 61010-1 specify the pollution degrees and their requirements as follows. The AFG-4000 falls under degree 2.

Pollution refers to “addition of foreign matter, solid, liquid, or gaseous (ionized gases), that may produce a reduction of dielectric strength or surface resistivity”.

- Pollution degree 1: No pollution or only dry, non-conductive pollution occurs. The pollution has no influence.
- Pollution degree 2: Normally only non-conductive pollution occurs. Occasionally, however, a temporary conductivity caused by condensation must be expected.
- Pollution degree 3: Conductive pollution occurs, or dry, non-conductive pollution occurs which becomes conductive due to condensation which is expected. In such conditions, equipment is normally protected against exposure to direct sunlight, precipitation, and full wind pressure, but neither temperature nor humidity is controlled.

Storage environment

- Location: Indoor
- Relative Humidity: <70%
- Temperature: -20°C to 60°C

Disposal



Do not dispose this instrument as unsorted municipal waste. Please use a separate collection facility or contact the supplier from which this instrument was purchased. Please make sure discarded electrical waste is properly recycled to reduce environmental impact.

Power cord for the United Kingdom

When using the function generator in the United Kingdom, make sure the power cord meets the following safety instructions.

NOTE: This lead/appliance must only be wired by competent persons



WARNING: THIS APPLIANCE MUST BE EARTHED

IMPORTANT: The wires in this lead are coloured in accordance with the following code:

Green/ Yellow:	Earth
Blue:	Neutral
Brown:	Live (Phase)



As the colours of the wires in main leads may not correspond with the coloured marking identified in your plug/appliance, proceed as follows:

The wire which is coloured Green & Yellow must be connected to the Earth terminal marked with either the letter E, the earth symbol  or coloured Green/Green & Yellow.

The wire which is coloured Blue must be connected to the terminal which is marked with the letter N or coloured Blue or Black.

The wire which is coloured Brown must be connected to the terminal marked with the letter L or P or coloured Brown or Red.

If in doubt, consult the instructions provided with the equipment or contact the supplier.

This cable/appliance should be protected by a suitably rated and approved HBC mains fuse: refer to the rating information on the equipment and/or user instructions for details. As a guide, a cable of 0.75mm² should be protected by a 3A or 5A fuse. Larger conductors would normally require 13A types, depending on the connection method used.

Any exposed wiring from a cable, plug or connection that is engaged in a live socket is extremely hazardous. If a cable or plug is deemed hazardous, turn off the mains power and remove the cable, any fuses and fuse assemblies. All hazardous wiring must be immediately destroyed and replaced in accordance to the above standard.

Safety Precaution before Operation

Check Power Supply

The analyzer is equipped with a three-wire power cord in accordance with international safety standards. The product must be grounded properly before being powered on, as floating or improper ground may cause damage to the instrument or personal injury.

Make sure the grounding conductor of the function generator is grounded before turning on the instrument. After which the AC power cord can be connected. Do not use a non-ground power cord.

Allowed Variation Range of Supply Power Parameters

The function generator is compatible with 100V~240V, 50Hz-60Hz AC power. The table below lists the power requirement to run the function generator.

Power Supply Parameter	Compatible Range
Voltage	100 - 240 VAC
Frequency	50 - 60 Hz $\pm 10\%$
Power	<50VA

To prevent or lower the risk of damage to the function generator from power interference between instruments, especially from peak pulses produced by large power consumption instruments, a 220V/110V AC regulated power supply is recommended.

Power Cord Selection

The analyzer is equipped with a three-wire power cord in accordance with international safety standards. This cable grounds the analyzer cabinet when connected to an appropriate power line outlet. The cable must be rated greater than 250Vac and 2A.

**WARNING**

Improper grounding may cause damage to the instrument, or result in personal injury. Make sure the grounding conductor of the function generator is grounded before turning on the instrument.

Always use a well-grounded power source. Do not use an external power cable, power cord or an auto transformer without grounded protection. If this product is to be powered via an external auto transformer for voltage reduction, ensure that its common terminal is connected to a neutral (earthed pole) of the power supply.

Make sure the supply power is stable before turning on the analyzer to protect it from damage. Refer to “First Time to Power on” on page 11.

Electro-static Discharge (ESD) Protection

ESD is an issue often ignored by users. Damage from ESD on the instrument is unlikely to occur immediately but will significantly reduce the reliability of it. Therefore, ESD precautions should be implemented in the work environment, and applied daily.

Generally, there are two steps to manage ESD protection:

1. Conductive table mats to connect hands via wrist bands
2. Conductive ground mat to connect feet via ankle straps

Implement both protection methods will provide a good level of anti-static protection. If used alone, the protection will not be as reliable. To ensure user's safety, anti-static components should offer at least $1M\Omega$ isolation resistance.



WARNING

The above ESD protections measures cannot be used when working with over 500V!

Make good use of anti-static technology to protect components from damage:

1. Quickly ground the internal and external conductor of the coaxial cable before it is connected with the function generator.
2. Staff must wear anti-static gloves before touching the connector cord or doing any assemble work.
3. Assure all the instruments are grounded properly to avoid static storage.

First Time to Power on

Connect the three-pin AC power cord into the instrument. Insert the plug into a power socket provided with a protective ground.



WARNING

Check the power source before turning on the function generator, to protect the device from damage.

Steps

1. Press the power switch  on the bottom left of the front panel.
2. Self-initialization takes about 30 seconds, after the boot screen the function generator will default to the scanning curve.
3. After power on, let the function generator warm up for 60 minutes for stabilization to obtain the most accurate results.

G E T T I N G S T A R T E D

This chapter introduces the front / rear panel, the user interface and explains how to use the instrument with a measurement example demonstration.

Main Features	16
Appearance	18
AFG-4125E Front Panel.....	18
AFG-4125AE Front Panel.....	18
AFG-4225E/4235/4260/4280/4210H/4225H Front Panel ...	19
AFG-4125E/4125AE/4225E Rear Panel.....	22
AFG-4235/4260/4280/4210H/4225H Rear Panel.....	22
Boot Up	24
User Interface.....	25
Product Operation	28
Channel Settings.....	28
Turn on/off the channel output	28
Waveform Settings.....	28
Sine Wave Output	29
Set the frequency.....	29
Set the amplitude	30
Set the offset:	30
Set the phase.....	30
Square Wave Output.....	31
Triangle Wave Output	31
Set the symmetry.....	32
Pulse Wave Output.....	33
Set the pulse width	35
Set the duty cycle.....	35
Set the rise time.....	36
Set the fall time.....	37
Noise Wave Output	37
Arbitrary Wave Output.....	38

Set the sampling rate.....	38
Set the display function for arbitrary wave.....	38
Set the editing function for arbitrary wave.....	39
Set the built-in waveforms for arbitrary wave	40
Set the Save function for arbitrary wave	41
Set the Import function for arbitrary wave.....	41
Set the output function for arbitrary wave	42
Harmonic Wave Output	43
Function Overview of Harmonic Wave	43
Select the harmonic wave type	44
Even harmonics.....	44
Odd harmonics.....	44
Sequential harmonics	44
Customize	45
Set the total count of harmonic waves.....	45
Set the harmonic order number.....	45
Set the harmonic amplitude	46
Set the harmonic phase.....	46
Modulation Waveform Output.....	46
Amplitude Modulation (AM)	46
Setting procedure for AM	47
Double Side Band Amplitude Modulation (DSBAM)	48
Setting procedure for DSBAM	48
Frequency Modulation (FM).....	49
Setting procedure for FM.....	49
Phase Modulation (PM)	50
Setting procedure for PM	51
Pulse Width Modulation (PWM).....	52
Setting procedure for PWM.....	52
Amplitude Shift Keying (ASK).....	53
Setting procedure for ASK.....	53
Phase Shift Keying (PSK).....	54
Setting procedure for PSK.....	55
Frequency Shift Keying (FSK)	56
Setting procedure for FSK	56
Ternary Frequency Shift Keying (3FSK)	57
Setting procedure for 3FSK	58
Quaternary Frequency Shift Keying (4FSK).....	58
Setting procedure for 4FSK	59
Binary Phase Shift Keying (BPSK)	59
Setting procedure for BPSK.....	60
Quadrature Phase Shift Keying (QPSK).....	60
Setting procedure for QPSK	61

Oscillation Shift Keying (OSK).....	61
Setting procedure for OSK.....	62
SUM Modulation (SUM)	62
Setting procedure for SUM.....	63
Sweep Frequency Output	64
Setting procedure for the sweep mode:.....	64
Burst Waveform Output	66
Set the Burst for N cycles.....	67
Set the Burst for gating.....	68
Frequency Counter.....	70
Utility Settings.....	71
Display Settings	72
Backlight.....	72
Screen Saver	72
Separator.....	73
CH1/CH2 Settings	73
Dual CH Settings.....	73
I/O Settings	74
System Settings.....	75
Language	75
Beeper.....	75
Clock Reference.....	75
Clock Output.....	76
Date	76
Upgrade.....	76
Save/Recall.....	77
Operation Procedure.....	78
Set to the Factory Defaults (Preset)	79
Channel (CH1/CH2) Function Settings.....	82
Set the load value.....	82
Setting procedure for CH1 or CH2 load value	82
Sync Int	82
Remote Control	85
Establishing a Remote Connection.....	85
Using the USB Interface.....	85
Using the LAN Interface.....	87
Direct connection.....	87

Main Features

- Provide single-channel or dual-channel output
 - AFG-4125E/ 4125AE: single channel
 - AFG-4225E/ 4235/ 4260/ 4280/ 4210H/ 4225H: dual-channel
 - Built-in Sine, Square, Triangle, Ramp, Pulse, Noise, Harmonic wave, Arbitrary wave
 - Min. resolution is 1uHz
 - Arbitrary function
 - Sampling Range
 - AFG-4225H: 1.25GSa/s
 - AFG-4235/ 4260/ 4280/ 4210H: 500MSa/s
 - AFG-4125E/ 4125AE/ 4225E: 125MSa/s
 - Amplitude Resolution
 - AFG-4235/ 4260/ 4280/ 4210H/ 4225H: 16 bits
 - AFG-4125E/ 4125AE/ 4225E: 14bits
 - Memory Length
 - AFG-4225E / 4235/ 4260/ 4280/ 4210H/ 4225H: 10M/per channel
 - AFG-4125E/ 4125AE: 16k/per channel
 - Provide modulation: AM, DSB-AM, FM, PM, PWM, ASK, PSK, BPSK, QPSK, FSK, 3FSK, 4FSK, OSK, SUM
 - Built-in sweep, burst, counter function
 - Built-in Power Amplifier function (AFG-4125AE)
 - Communication interface
 - AFG-4235/ 4260/ 4280/ 4210H/ 4225H provide USB, LAN interface
-

- AFG-4125E/ 4125AE/ 4225E provide USB interface
 - 8" TFT LCD Display, 800*480 resolution
 - Multi-Touch Display: AFG-4235/ 4260/ 4280/ 4210H/ 4225H
 - Without Touch Display: AFG-4125E/ 4125AE/ 4225E
-

Appearance

AFG-4125E Front Panel

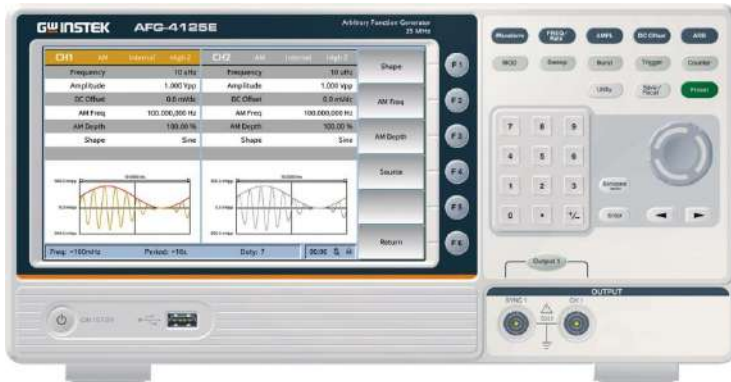





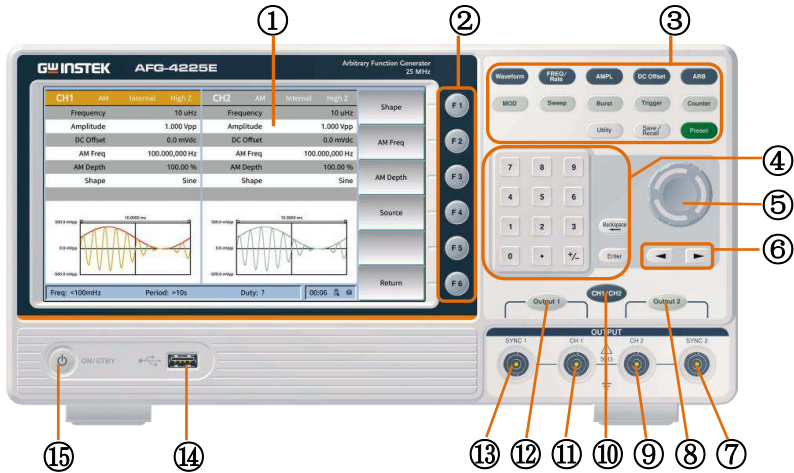

AFG-4125AE Front Panel



AFG-4225E/4235/4260/4280/4210H/4225H Front Panel

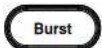

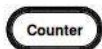
1. LCD Display the user interface.
2. Menu soft keys (F1) ~ (F6) The F1 to F6 function keys directly correspond to the soft keys on the right-hand side of display.
3. Function keys
 - Waveform** Basic waveform buttons, including sine waves, square waves, triangle waves, pulse waves, noise waves, and harmonics;
 - FREQ/Rate** The FREQ/Rate key is used to set the frequency or sample rate.
 - AMPL** AMPL sets the waveform amplitude.
 - DC Offset** Sets the DC offset.
 - ARB** ARB is used to set the arbitrary waveform parameters.

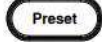
-  **MOD** Output modulation waveform;
-  **Sweep** Sweep sine, square, triangle or arbitrary waves;
-  **Burst** Generate pulse trains of sine waves, square waves, triangle waves, pulse waves, noise waves or arbitrary waves;
-  **Trigger** Manual trigger button;
-  **Counter** Frequency counter button;
-  **Utility** Auxiliary function button;
-  **Save/Recall** Save/recall function button;
-  **Preset** Restore factory settings button.

4. Numeric keyboard



Parameter input.

5. Scroll Wheel



During parameter editing, turn the knob clockwise to increase, or counter clockwise to decrease the parameter values at specified steps.

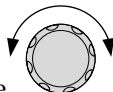

Decrease Increase

6. Arrow keys



Move the cursor of the selected parameter.

- 7. CH2 Synchronou
s output
terminal



When **Utility** → CH1/2 Settings → CH2 Synchronization is set to On, this terminal outputs a synchronization signal that matches the current configuration of CH2.
- 8. CH2 Signal
output
button



Turn on or off the output of CH2 channel waveform or synchronization signal. When the output is turned on, the button backlight lights up.
- 9. CH2
Output



Output CH2 channel signal.
- 10 CH1/CH2
.



CH1 and CH2 channel display interface switching button.
- 11 CH1
.
Output



Output CH1 channel signal.
- 12 CH1 Signal
.
output
button



Turn on or off the output of CH1 channel waveform or synchronization signal. When the output is turned on, the button backlight lights up.
- 13 CH1
.
Synchronou
s output
terminal



When **Utility** → CH1/2 Settings → CH1 Synchronization is set to On, this terminal outputs a synchronization signal that matches the current configuration of CH1.
- 14 USB
.
interface



Connect to an external USB Host device, such as inserting a USB flash drive.
- 15 Power
.
button



Turn the power on or off.
- 16 Power
Amplifier
out



Power Amplifier output port
- 17 Power
Amplifier in



Power Amplifier input port

AFG-4125E/4125AE/4225E Rear Panel

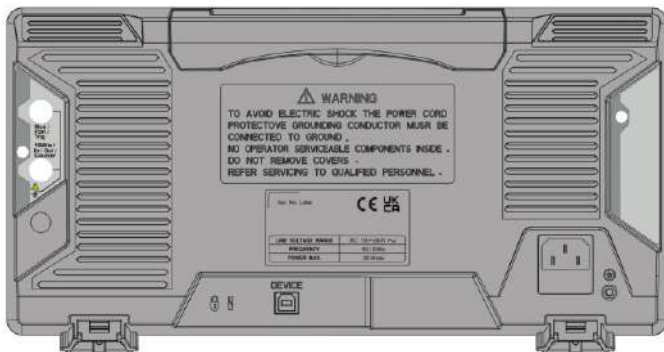

AFG-4235/4260/4280/4210H/4225H Rear Panel

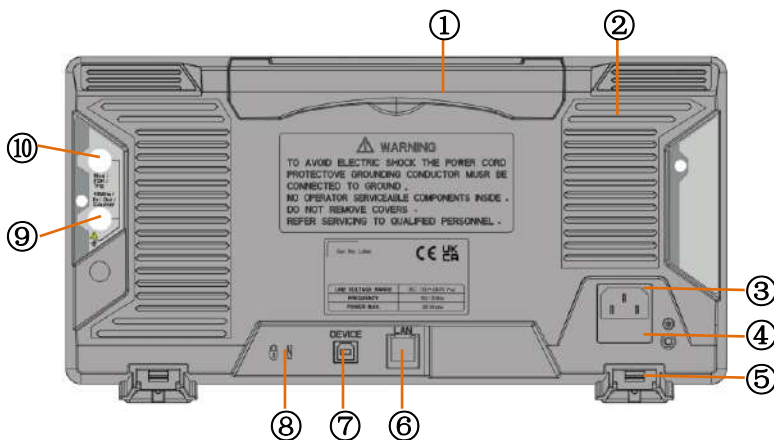

1. Handle
2. Heat sink fan
3. AC Power Input Socket



Power input: 100-240V±10% AC
50-60Hz.
4. Fuse box



F2A/250V
5. Stool



To adjust the angle of the device.
6. LAN Port



LAN interface for remote control.

- 7. USB Device Port

DEVICE



USB type-B device port is used to connect the function generator to a PC for remote control.
- 8. Security Lock Hole



Users can use the security lock (buy it by themselves) to lock the instrument at a fixed location.
- 9. 10MHz In/Out/Counter Connector



Default is used to receive frequency meter input signal. When the instrument is set to the internal clock source and **Utility** → System Settings → Clock Output is set to on, it is used to output a 10MHz clock signal; when the instrument is set to an external clock source, it is used to receive an external 10MHz clock signal.
- 10. Mod/FSK/Trigger Connector



When modulating waveform, output scanning frequency, or output pulse train, the signal connected here can be used as an external signal source.

Note: If one channel turns on AM, FM, PM, PWM or OSK, and another channel turns on ASK, FSK, PSK, frequency sweep or pulse train, and both channels are set to external trigger, the channel where the trigger source is set later can When using an external trigger, the other channel will automatically cancel the external trigger due to a different type of external modulation signal.

Boot Up

Confirm AC voltage Before turning on the power, confirm that the input power meets the conditions of 100-240 V ($\pm 10\%$), 50/60 Hz.

Connect the AC power cord The fuse is a 250 V, F2AL slow-blow type, and connects the AC power cord to the rear panel receptacle.



Warning

To prevent electric shock, please make sure the instrument is properly grounded.

Power on Press the power switch to turn on the power.

Power off Press the power switch again, the status light will show blue, and turn off the power of the whole machine.

User Interface

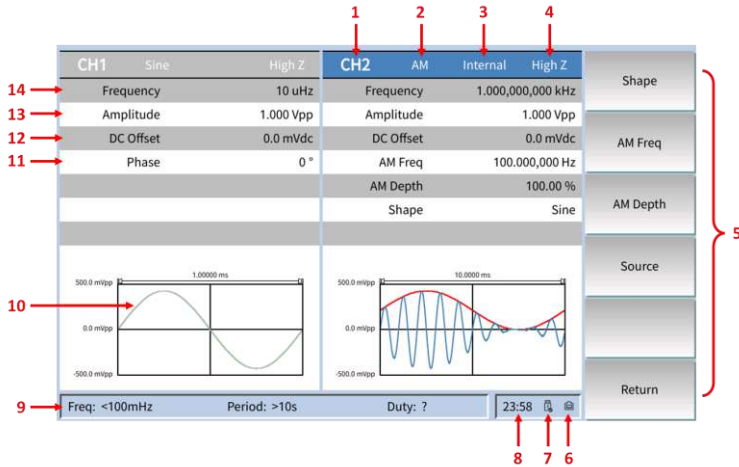

NO Description

- | | | |
|---|--|---|
| 1 | Channel Status | Display areas of CH1 and CH2. Indicate whether the corresponding channel is selected and turned on (ON/OFF). The area of the channel currently selected is highlighted and the on/off state of the channel currently turned on is "ON". |
| 2 | Current waveform or Current Modulation | |
| 3 | Trigger Source | Internal: internal modulation or internal trigger source;
External: external modulation or external trigger source;
Manual: Manual trigger source. |
| 4 | Output impedance | 50Ω or high impedance |

5	Menu	Display the operation menu corresponding to the function currently selected. For example, the "Sine" function menu is displayed in the above figure.
6	LAN status light	When the instrument is correctly connected to the LAN, this indicator will light.
7	USB status light	When the generator detects a USB storage device, this indicator will light.
8	Time	Display the current time.
9	Counter	<p>The brief information of the counter will only be displayed when the frequency counter function is turned on and the interface currently displayed is not the frequency counter interface.</p> <p>When the statistic function is turned off: only display the frequency and period.</p> <p>When the statistic function is turned on: display the measurement parameters currently selected, the on/off status of the statistic function, the measurement values and the number of measurements.</p>
10	Waveform	Display the currently selected waveform shape in each channel.
11	Phase	Display the current waveform phase in each channel. Press the corresponding softkey Start Phase and use the numeric keyboard or direction keys and knob to modify this parameter. The parameter that can be modified currently will be highlighted and the lightspot above the number indicates current cursor location.

-
- | | |
|--------------|--|
| 12 Offset | Display the current waveform DC offset in each channel. Press the corresponding softkey Offset and use the numeric keyboard or direction keys and knob to modify this parameter. The parameter that can be modified currently will be highlighted and the lightspot above the number indicates current cursor location. |
| 13 Amplitude | Display the current waveform amplitude in each channel. Press the corresponding softkey Ampl and use the numeric keyboard or direction keys and knob to modify this parameter. The parameter that can be modified currently will be highlighted and the lightspot above the number indicates current cursor location. |
| 14 Frequency | Display the current waveform frequency in each channel. Press the corresponding softkey Freq and use the numeric keyboard or direction keys and knob to modify this parameter. The parameter that can be modified currently will be highlighted and the lightspot above the number indicates current cursor location. |
-

Product Operation

The operating methods of AFG-4000 are provided in the present section as a quick start guide for users. For its program control, factory default settings and other details, refer to other sections of this manual.

Channel Settings

Select a channel for configuration:

Select a channel for configuration before configuring waveform parameters. You can switch between channels by pressing **CH1/CH2** twice; alternatively, you may directly click on the touch screen and the corresponding channel area in the user interface will become brighter.

Turn on/off the channel output

You can turn on/off the output of a corresponding channel by pressing **Output1** or **Output2** on the front panel. The backlight of this button will be lit while the output is turned on.

Waveform Settings

After pressing Waveform and ARB on the front panel of this instrument, you can set and output sine wave, square wave, triangle wave, pulse wave, noise wave, harmonic wave and arbitrary wave, and you can enter the corresponding waveform setup interface. Settable parameters vary with waveforms.



Note

The following waveform settings procedure is based on the example of Channel 1 (CH1). If you want to set Channel 2 (CH2), please refer to the specific operation procedure for CH1.

Sine Wave Output

After you successively press **Waveform** and **F1**, the user interface (UI) for sine wave will appear. You can click the “Menu” button on the operation panel or directly click the corresponding menu box on the screen to set the output waveform parameters for sine wave.

The sine wave menu contains: frequency, amplitude, offset, and phase.

UI for Sine Wave

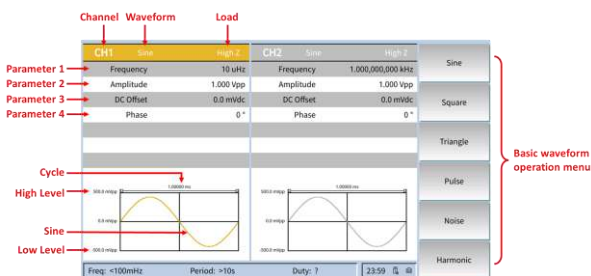

Set the frequency

- Press **CH1/CH2** to switch to Channel 1 (CH1); or at CH1 on the screen, all **CH1** menu items currently selected will be highlighted.
- After you press **FREQ/Rate**, corresponding parameter items will be displayed within **Parameter 1 in the UI for Sine Wave**.

You can change any parameter value already selected in the following three ways

- You can turn the **knob** to increase or decrease the value indicated by the cursor. Move the cursor side to side by pressing the direction keys **◀/▶**.
- Directly press a numeric key on the **numeric keypad** to enter the desired value. You can delete the last digit by pressing the soft key

Backspace. You can confirm the default unit already input by pressing **Enter**. You can also press a soft key **MHz, kHz, Hz, mHz, or uHz** to select the unit of parameter.

- After you directly click the **Frequency** on the screen, a numeric input field will pop up. Just continue to enter the desired value. You can delete the last digit by pressing the soft key **←**. You can confirm the default unit already input by pressing the soft key **Enter**. You can also press a soft key **MHz, kHz, Hz, mHz, or uHz** to select the unit of parameter.

Frequency Setting via the Touch Screen

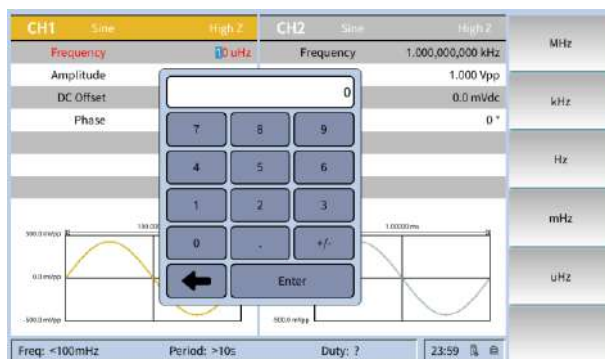

Set the amplitude

Press **AMPL**. Within **Parameter 2 in the UI for Sine Wave**, use the knob, numeric keypad or touch screen to set the desired value.

Set the offset:

Press **DC Offset**. Within **Parameter 3 in the UI for Sine Wave**, use the knob, numeric keypad or touch screen to set the desired value.

Set the phase

Successively press CH1/CH2 and F2. Within **Parameter 4 in the UI for Sine Wave**, use the knob, numeric keypad or touch screen to set

the desired value. After you press F3, you can set the phase to 0° via this shortcut button.

Square Wave Output

After you successively press **Waveform** and **F2**, the UI for square wave will appear. You can click the “Menu” button on the operation panel or directly click the corresponding menu box on the screen to set the output waveform parameters for square wave.

The square wave menu contains: frequency, amplitude, offset, and phase.

Please refer to the “Sine Wave Output” section for the settings of frequency, amplitude, offset, and phase.

UI for Square Wave

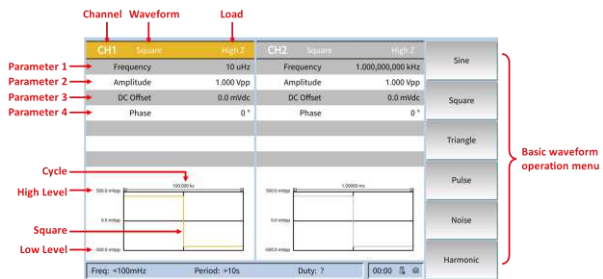

Triangle Wave Output

After you successively press **Waveform** and **F3**, the UI for triangle wave will appear. You can click the “Menu” button on the operation panel or directly click the corresponding menu box on the screen to set the output waveform parameters for triangle wave.

The triangle wave menu contains: frequency, amplitude, offset, phase, and symmetry.

Please refer to the “Sine Wave Output” section for the settings of frequency, amplitude, offset, and initial phase.

UI for Triangle Wave

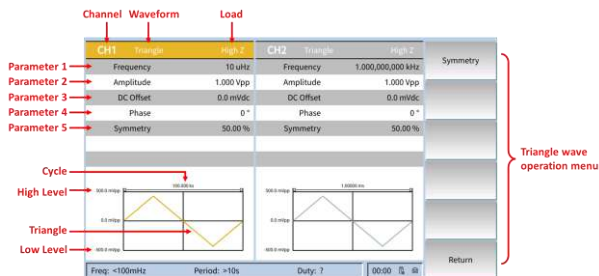

Glossary

Symmetry: It is used to set the percentage of cycles when triangle wave is rising.

Set the symmetry

Steps

1. Use the **knob** to directly change the value within **Parameter 5 in the UI for Triangle Wave**; alternatively, use the **numeric keypad** to enter the value. After you press **Enter**, the symmetry value already entered will be displayed. You can delete the last digit by pressing the soft key **Backspace**. You can confirm the default input by pressing the soft key **Enter**.
2. After you directly click the **Symmetry** on the screen, a numeric input field will pop up. Just continue to enter the desired value. You can delete the last digit by pressing the soft key **←**. You can confirm the default unit already input by pressing the soft key **Enter**.

Symmetry Setting for Triangle Wave

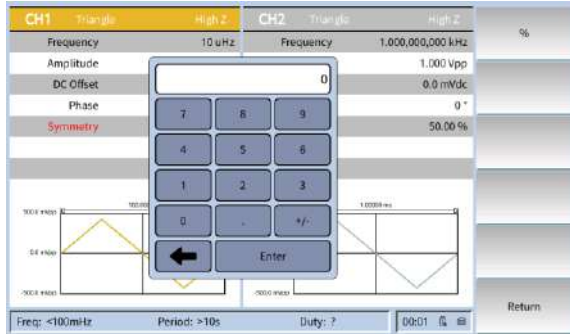

Pulse Wave Output

After you successively press **Waveform** and **F4**, the UI for pulse wave will appear. You can click the “Menu” button on the operation panel or directly click the corresponding menu box on the screen to set the output waveform parameters for pulse wave.

The pulse wave menu contains: frequency, amplitude, offset, phase, pulse width/duty cycle, and lead time/trail time.

Please refer to the “Sine Wave Output” section for the settings of frequency, amplitude, offset, and phase.

UI for Pulse Wave

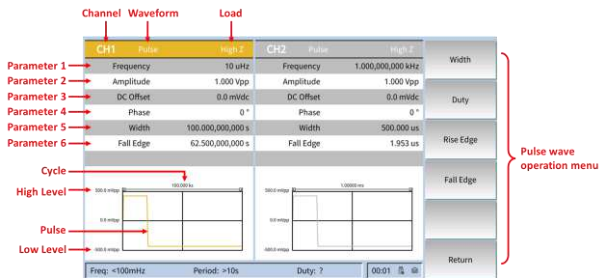

Glossary

PW:

PW is the abbreviation of pulse width, which consists of positive PW and negative PW.

A positive PW is defined as the time from the middle threshold (50%) of the rising edge to the middle threshold (50%) of the next falling edge.

A negative PW is defined as the time from the middle threshold (50%) of the falling edge to the middle threshold (50%) of the next rising edge.

PW depends on the signal cycle and duty cycle, with the calculation formula as: $PW = \text{cycle} \times \text{duty cycle}$.

Duty Cycle:

It is defined as the ratio of the positive pulse duration to the total pulse period in an ideal pulse train (such as square waves).

Pulse Duty Cycle:

PW is defined as the time from the middle threshold (50%) of a pulse's rising edge to the middle threshold (50%) of the next falling edge, as shown below:

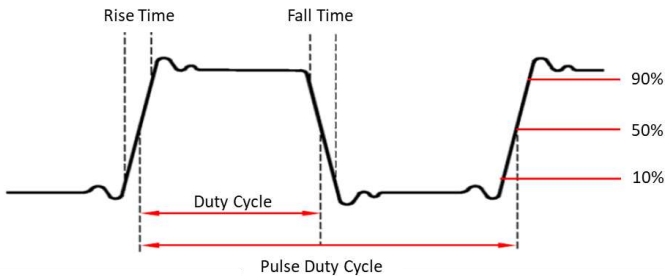

- The setting range of PW is subject to the “minimum pulse width” and the “pulse period.”
 $PW \geq \text{minimum pulse width}$
 $PW \leq \text{pulse period} - \text{minimum pulse width}$
- Pulse duty cycle is defined as the percentage of a PW in the pulse period.
- As pulse duty cycle is associated with PW, change to either parameter will lead to automatic change to the other one. Pulse duty cycle is subject to the “minimum pulse width” and the “pulse period.”
 $\text{Pulse duty cycle} \geq \text{minimum pulse width} \div \text{pulse period} \times 100\%$
 $\text{Pulse duty cycle} \leq (1 - 2 \times \text{minimum pulse width} \div \text{pulse period}) \times 100\%$
- The settable range of rise/fall time is limited by "Minimum Pulse Width" and "Period"
 $8\text{ns} \leq \text{Period} \times 0.000625 \leq \text{Rise/Fall Time Setting} \leq \text{Minimum Pulse Width} \times 0.625$

Set the pulse width

Press **F1** to set the parameter value of **pulse width** (PW). Use the **knob** to directly change the PW value within **Parameter 5 in the UI for Pulse Wave**; alternatively, use the **numeric keypad** to enter the value. Next, select the desired unit from the menu on the right side. You can enter the desired value by clicking the desired unit (ks, s, ms, us, ns) or pressing **Enter**. You can delete the last digit by pressing the soft key **Backspace**. You can confirm the default input by pressing the soft key **Enter**, or you can directly click the **Pulse Width** on the screen, and a numeric input field will pop up. Just continue to enter the desired value. You can delete the last digit by pressing the soft key **←**. You can confirm the default unit already input by pressing the soft key **Enter**. You can also press a soft key **ks, s, ms, us, or ns** to select the unit of parameter.

Set the duty cycle

Press **F2** to set the parameter value of **duty cycle**. Use the **knob** to directly change the duty cycle value; alternatively, use the **numeric keypad** to enter the value. Next, press **%** or **Enter** from the menu on the right side to enter the desired value. You can delete the last digit by pressing the soft key **Backspace**. You can confirm the default input by pressing the soft key **Enter**; or you can directly click the **Duty Cycle** on the screen, and a numeric input field will pop up. Just continue to enter the desired value. You can delete the last digit by pressing the soft key **←**. You can complete the value entry by pressing the soft key **%** or **Enter**.

Pulse Width Setting for Pulse Waves

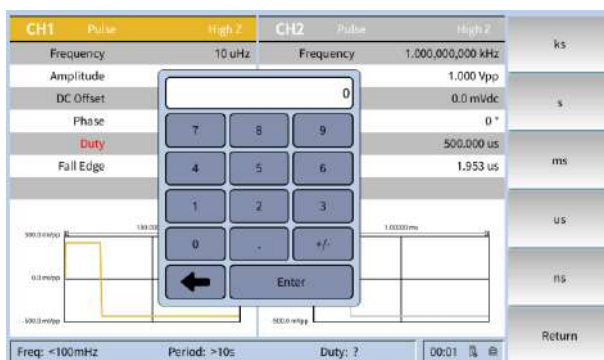

Set the rise time

Press **F3** to set the parameter value of **rise time**. Use the **knob** to directly change the lead time value within **Parameter 6 in the UI for Pulse Wave**; alternatively, use the **numeric keypad** to enter the value. Next, select the desired unit from the menu on the right side. You can enter the desired value by clicking the desired unit (ks, s, ms, us, ns) or pressing **Enter**. You can delete the last digit by pressing the soft key **Backspace**. You can confirm the default input by pressing the soft key **Enter**; or you can directly click the **rise time** on the screen, and a numeric input field will pop up. Just continue to enter the desired value. You can delete the last digit by pressing the soft key **←**. You can confirm the default unit already input by pressing the soft key **Enter**. You can also press a soft key **ks, s, ms, us, or ns** to select the unit of parameter.

Set the fall time

Press **F4** to set the parameter value of **fall time**. Use the **knob** to directly change the trail time value within **Parameter 6 in the UI for Pulse Wave**; alternatively, use the **numeric keypad** to enter the value. Next, select the desired unit from the menu on the right side. You can enter the desired value by clicking the desired unit (ks, s, ms, us, ns) or pressing **Enter**. You can delete the last digit by pressing the soft key **Backspace**. You can confirm the default input by pressing the soft key **Enter**; or you can directly click the **fall time** on the screen, and a numeric input field will pop up. Just continue to enter the desired value. You can delete the last digit by pressing the soft key **←**. You can confirm the default unit already input by pressing the soft key **Enter**. You can also press a soft key **ks, s, ms, us, or ns** to select the unit of parameter.

Noise Wave Output

After you successively press Waveform and F5, the UI for noise wave will appear. You can click the “Menu” button on the operation panel or directly click the corresponding menu box on the screen to set the output waveform parameters for noise wave.

Such parameters as frequency and period are not available for noise wave, which is Gaussian noise with a bandwidth of 120 MHz.

The noise wave menu contains: frequency and offset.

Please refer to the “Sine Wave Output” section for the settings of amplitude and offset.

UI for Noise Wave

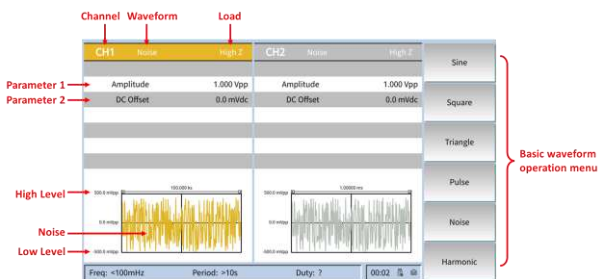

Arbitrary Wave Output

After you press **ARB** twice, the UI for arbitrary wave will appear. You can operate the arbitrary wave menu to set the output waveform parameters for arbitrary wave.

The arbitrary wave menu contains: **frequency**, **amplitude**, **offset**, **phase** and **sampling rate**.

Please refer to the “Sine Wave Output” section for the settings of frequency, amplitude and offset.

UI for Arbitrary Wave

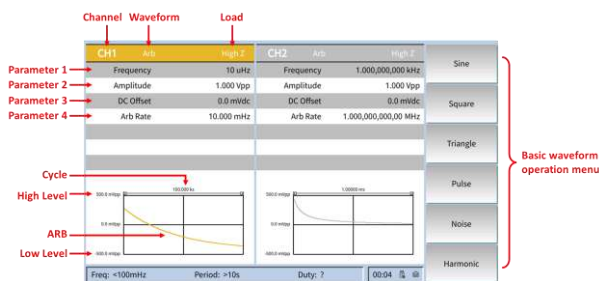

Set the sampling rate

Press **FREQ/Rate**. When the menu item “Sampling Rate” is displayed in red, you can use the **knob**, **numeric keypad** or **touch screen** within **Parameter 4 in the UI for Arbitrary Wave** to set the desired value.

Set the display function for arbitrary wave

By using the display function, the user can set the horizontal display range or vertical display range of the waveform as needed. The operation procedure is stated below:

Steps

1. Successively press **ARB** and **F1** to enter the display function menu.
2. Press **F1** to enter the horizontal display function menu. Set the start point, length and center of the waveform to be displayed as needed. Click “OK” to save the settings. Click

- “**Back**” to return to the previous menu. Click **Zoom In** or **Zoom Out** to enlarge or shrink the displayed waveform.
3. Press **F2** to enter the vertical display function menu. Set the lowest point, highest point and center of the waveform to be displayed as needed. Click “**OK**” to save the settings. Click “**Back**” to return to the previous menu. Click **Zoom In** or **Zoom Out** to enlarge or shrink the displayed waveform.
 4. Press **F3** to move the display window forwards.
 5. Press **F4** to move the display window backwards.
 6. Press **F5** to display the entire waveform.
 7. Press **F6** to return to the previous menu.

Set the editing function for arbitrary wave

By using the editing function, the user can create points and lines at any locations of the waveform. The operation procedure is stated below:

-
- | | |
|-------|--|
| Steps | <ol style="list-style-type: none">1. Successively press ARB and F2 to enter the editing function menu.1. Press F1 to enter the Point Editing function menu. Set the Address and Data for editing points as needed. Click “Enter” to save the settings. Click “Return” to return to the previous menu.2. Press F2 to enter the Line Editing function menu. Set the Start Address, Start Data, Stop Address and Stop Data for editing lines as needed. Click “Done” to save the settings. Click “Return” to return to the previous menu. |
|-------|--|

3. Press **F3** to enter the **Copy function** menu. Set the **From**, **Length** and **Paste To** for copying as needed. Click **“Done”** to save the settings. Click **“Return”** to return to the previous menu.
4. Press **F4** to enter the **Clear function** menu. Set the **Start** and **Length** for clearing as needed. Click **“Done”** to save the settings. Click **“Complete”** to clear the waveform address already set. Successively click **“All”** and **“Complete”** to clear the addresses of all waveforms. Click **“Return”** to return to the previous menu.
5. Press **F5** to enter the **Protection function** menu. Set the **Start** and **Length** for protection as needed. Click **“Done”** to save the settings. Click **“Complete”** to protect the waveform address already set. Successively click **“All”** and **“Complete”** to protect the addresses of all waveforms. Click **“Unprotect”** to unprotect the addresses of all waveforms. Click **“Done”** to return to the previous menu.

Set the built-in waveforms for arbitrary wave

There are 146 types of built-in waveforms in the system. The upper limiting frequency is 15 MHz. You can select built-in waveforms according to the following procedure:

-
- | | |
|-------|--|
| Steps | <ol style="list-style-type: none">1. Successively press ARB, F3 and F4 to enter and select a menu.2. Press the soft key Common, Medical, Standard, or Maths to select the type of the built-in waveform.3. Press the soft key Next to enter the menu and select built-in waveforms: Trigonometric, Window, Engineer, and Segmented Modulation. For example, you will enter the |
|-------|--|

screen shown below after selecting Maths.



Turn the **knob** or directly click the pop-up window on the screen to select the desired waveform (such as **Airy**). Press the knob or **F1** to output the **Airy Function**.

Set the Save function for arbitrary wave

By using the Save function, the user can save the waveform in the memory or USB as needed. The operation procedure is stated below:

Steps

1. Successively press **ARB** and **F4** to enter the Save function menu.
2. Press **F1** and set the start point of the waveform to be displayed as needed. Click **Enter** to save the settings. Click **Return** to return to the previous menu.
3. Press **F2** and set the length of the waveform to be displayed as needed. Click **Enter** to save the settings. Click **Return** to return to the previous menu.
4. Press **F3** to save the waveform in the memory.
5. Press **F4** to save the waveform in the USB.
6. Press **F6** to return to the previous menu.

Set the Import function for arbitrary wave

By using the Import function, the user can select and recall the waveforms stored in the memory or USB. The operation procedure is stated below:

- | | |
|-------|--|
| Steps | <ol style="list-style-type: none">1. Successively press ARB and F5 to enter the Import function menu.2. Press F1 to recall any waveforms in the memory. Click "Select" to write a file. Click "Delete" to delete the selected file. Click "Return" to return to the previous menu.3. Press F2 to recall any waveforms in the USB. Click "Select" to write a file. Click "Delete" to delete the selected file. Click "Return" to return to the previous menu.4. Press F3 and click "Enter". Select the start point of the waveform already recalled. Click "Clear" to clear the data for which "Return" is not clicked and then return to the previous set value.5. Press F5 to complete waveform recalling.6. Press F6 to return to the previous menu. |
|-------|--|

Set the output function for arbitrary wave

By using the output function, the user can intercept and output the start point and length of the waveform. The operation procedure is stated below:

- | | |
|-------|--|
| Steps | <ol style="list-style-type: none">1. Successively press ARB and F6 to enter the output function menu.2. Press F1 and click "Enter". Select the start point of the waveform to be output. Click "Clear" to clear the data for which "Enter" is not clicked and then return to the previous set value.3. Press F2 and click "Enter". Set the length of the waveform to be output. Click "Clear" to |
|-------|--|

clear the data for which “Enter” is not clicked and then return to the previous set value.

4. Press **F6** to return to the previous menu.

Harmonic Wave Output

After you successively press **Waveform** and **F6**, the UI for harmonic wave will appear. You can click the “Menu” button on the operation panel or directly click the corresponding menu box on the screen to set the output waveform parameters for harmonic wave.

The harmonic wave menu contains: frequency, amplitude, offset, phase, harmonic wave type, total count of harmonic waves, harmonic order number, harmonic amplitude, and harmonic phase.

Please refer to the “Sine Wave Output” section for the settings of frequency, amplitude, offset, and phase.

Function Overview of Harmonic Wave

It can be known from the theory of Fourier transform that the time domain waveform is the superposition of a series of sine waves, expressed by the following equation:

$$f(t) = A_1 \sin(2\pi f_1 t + \varphi_1) + A_2 \sin(2\pi f_2 t + \varphi_2) + A_3 \sin(2\pi f_3 t + \varphi_3) + \dots$$

Generally, the component with the frequency “ f_1 ” is called “fundamental harmonic”; f_1 is fundamental frequency; A_1 is fundamental-harmonic amplitude; and φ_1 is fundamental-harmonic phase. The frequencies of other components are usually integer multiples of the fundamental frequency, and those components are called “Harmonic Waves”. The components with frequencies that are odd multiples of the fundamental frequency are called “Odd Harmonics.” The components with frequencies that are even multiples of the fundamental frequency are called “Even Harmonics.”

UI for Harmonic Wave

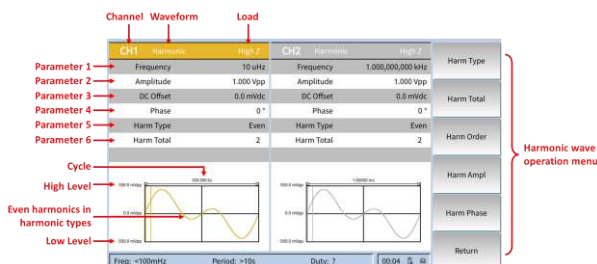

This signal source can output up to 16 harmonic orders. After selecting CH1 or CH2, press **F6** on the front panel to enter the Harmonic Wave Settings menu. You can set the parameters of the fundamental harmonic, select the type of the harmonic wave to be output and specify its highest harmonic order as well as the amplitude and phase of individual harmonic waves.

Select the harmonic wave type

This signal source can output even harmonics, odd harmonics, sequential harmonics, or harmonics with the user-defined order. Enter the Harmonic Wave Settings menu. Press **F1** to select the desired harmonic wave type.

Even harmonics

Press **F1** to enter the menu and select the option “harmonic wave type.” Next, press **F1** and the instrument will output the fundamental harmonic and even harmonics.

Odd harmonics

Press **F1** to enter the menu and select the option “harmonic wave type.” Next, press **F2** and the instrument will output the fundamental harmonic and odd harmonics.

Sequential harmonics

Press **F1** to enter the menu and select the option “harmonic wave type.” Next, press **F3** and the instrument will output the fundamental harmonic and harmonic waves in sequence.

Customize

Press **F1** to enter the menu and select the option “harmonic wave type.” Next, press **F4** and the user can customize the order of harmonic waves to be output. The maximum order is 16. 16 binary digits are used to represent the output states of 16 harmonic waves respectively. “1” indicates turning on the output of the harmonic wave of the corresponding order; “0” indicates turning off the output of the harmonic wave of the corresponding order. The user only needs to modify the value of each data bit with the numeric keypad (note: the bit on the leftmost side represents the fundamental harmonic and is fixed at “X” and cannot be modified). For example, 16 data bits are set as X001 0000 0000 0001, indicating the fundamental harmonic, 4 harmonic waves and 16 harmonic waves.



Note

The harmonic waves actually output is subject to the “harmonic order” currently specified.

Set the total count of harmonic waves

Press **F2** to set the parameter value of the **total count of harmonic waves**. Such parameter item is displayed in red. Within Parameter 6 in the **UI for Harmonic Wave**, use the **knob** or **numeric keypad** to set the desired value. The setting count range is 2-16.

Set the harmonic order number

Press **F3** to set the parameter value of the **harmonic order number**. Such parameter item is displayed in red. Within Parameter 5 in the **UI for Harmonic Wave**, use the **knob** or **numeric keypad**, or directly click the **Harmonic Order Number** on the screen. A numeric input field will pop up. Set the desired value. The setting count range is 2-16.

Set the harmonic amplitude

Press **F4** to set the parameter value of the **harmonic amplitude**. Such parameter item is displayed in red. Within Parameter 6 in the **UI for Harmonic Wave**, use the **knob** or **numeric keypad**, or directly click the **Harmonic Amplitude** on the screen. A numeric input field will pop up. Set the desired value.

Set the harmonic phase

Press **F5** to set the parameter value of the **harmonic phase**. Such parameter item is displayed in red. Within Parameter 7 in the **UI for Harmonic Wave**, use the **knob** or **numeric keypad**, or directly click the **Harmonic Phase** on the screen. A numeric input field will pop up. Set the desired value.

Modulation Waveform Output

Successively press the function key **MOD** and **F1-F6** to select a modulation type. Modulated waveforms can be output. Modulation type include: AM (amplitude modulation), DSBAM (double side band amplitude modulation), FM (frequency modulation), PM (phase modulation), PWM (pulse width modulation), ASK (amplitude shift keying), PSK (phase shift keying), FSK (frequency shift keying), 3FSK (ternary frequency shift keying), 4FSK (quaternary frequency shift keying), BPSK (binary phase shift keying), QPSK (quadrature phase shift keying), OSK (oscillation shift keying), and SUM (SUM modulation).



Note

The following modulation waveform output procedure is based on the example of Channel 1 (CH1). If you want to set Channel 2 (CH2), please refer to the specific operation procedure for CH1.

Amplitude Modulation (AM)

The output modulation waveform consists of carrier and modulating wave. A carrier may be a sine wave, square wave, triangle wave, or arbitrary wave. In an AM process, the carrier amplitude varies with the transient voltage of the modulation waveform. The UI for AM is illustrated below.

UI for Amplitude Modulation (AM)

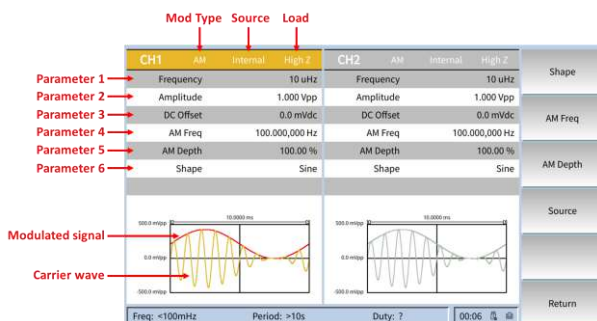

Setting procedure for AM

Steps

1. Successively press the function key **MOD** and **F1** to select **AM** as modulation type.
2. Press **Waveform** and the waveform and parameters of the current carrier will be displayed. You can change the carrier parameters. Refer to “**Sine Wave Output**” for more details. Press **MOD** again to go back to the Modulation Mode screen.
3. Press **F4** to select a signal source. If you select “**External**”, the setting procedure will be completed after the external signal source is connected to the **Ext Mod In** interface on the rear panel. If you select “**Internal**”, proceed the following procedure.
4. Press **F1** to select “**Shape**”. You can choose “**Sine**” (sine wave), **Square** (square wave), **Triangle** (triangle wave), **Noise** (noise wave), or **Arb** (arbitrary wave).
5. Press **F2** to set the AM frequency. The range of AM frequency is 2 mHz to 1 MHz (only for internal signal sources).

Glossary

AM Frequency: the frequency of modulation waveform;

Modulation Depth: the amplitude variation range of the output modulation waveform. During modulation at 0%, the output amplitude will be half of the amplitude setpoint. During modulation at 100%, the output amplitude will be equal to the amplitude setpoint. In case of an external signal source, the AM depth will be controlled by the signal level on the **Ext Mod In** connector. +1V indicates that the depth currently selected is 100%.

- Steps
1. Press **F3** to set the modulation depth. The modulation depth range is 0% to 120%.

Double Side Band Amplitude Modulation (DSBAM)

The output modulation waveform consists of carrier and modulating wave. A carrier may be a sine wave, square wave, triangle wave, or arbitrary wave.

UI for Double Side Band Amplitude Modulation (DSBAM)

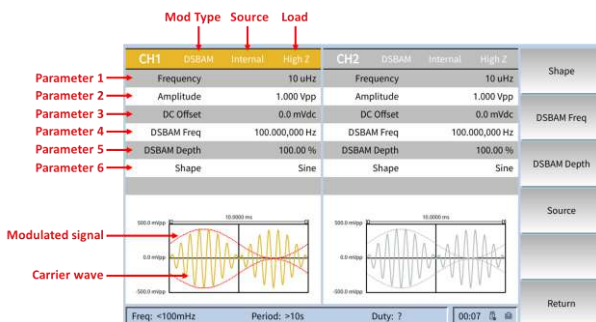

Setting procedure for DSBAM

- Steps
1. Successively press the function key **MOD** and **F2** to select **DSBAM** as modulation type.
 2. Press **Waveform** and the waveform and parameters of the current carrier will be

displayed. You can change the carrier parameters. Refer to “Sine Wave Output” for more details. Press **MOD** again to go back to the Modulation Mode screen.

3. Press **F4** to select a signal source. If you select “External”, the setting procedure will be completed after the external signal source is connected to the **Ext Mod In** interface on the rear panel. If you select “Internal”, proceed the following procedure.
4. Press **F1** to select a type of “Shape”. You can choose Sine, Square or Triangle.
5. Press **F2** to set the AM frequency. The range of AM frequency is 2 mHz to 1 MHz (only for internal signal sources).
6. Press **F3** to set the modulation depth. The modulation depth range is 0% to 100%.

Frequency Modulation (FM)

The output modulation waveform consists of carrier and modulating wave. A carrier may be a sine wave, square wave, triangle wave, or arbitrary wave. In a FM process, the carrier frequency varies with the transient voltage of the modulation waveform. The UI for FM is illustrated below.

UI for Frequency Modulation (FM)

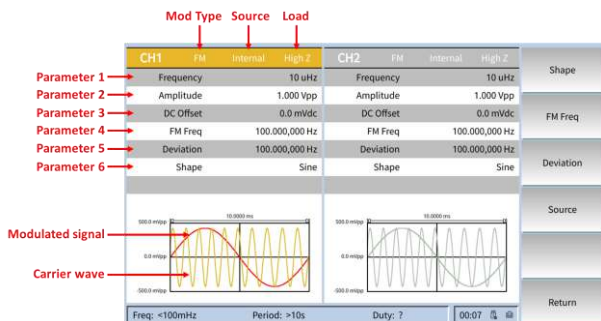

Setting procedure for FM

Steps

1. Successively press the function key **MOD** and **F3** to select **FM** as modulation type.
2. Press **Waveform** and the waveform and parameters of the current carrier will be displayed. You can change the carrier parameters. Refer to “Sine Wave Output” for more details. Press **MOD** again to go back to the Modulation Mode screen.
3. Press **F4** to select a signal source. If you select “External”, directly skip to Step (5) after the external signal source is connected to the **Ext Mod In** interface on the rear panel. If you select “Internal”, proceed the following procedure.
4. Press **F1** to select a type of “Shape”. You can choose Sine, Square, Triangle, Noise or Arb.
5. Press **F2** to set a Modulation Frequency value. The range of modulation frequency is 2 mHz to 1 MHz (only for internal signal sources).
6. Press **F3** to set a Frequency Shift value. Frequency shift range: $2 \text{ mHz} \leq \text{shift} \leq \text{min}$ (min is the carrier frequency or maximum carrier frequency; the carrier frequency will be the smaller of both values by default)

Phase Modulation (PM)

The output modulation waveform consists of carrier and modulating wave. A carrier may be a sine wave, square wave, triangle wave, or arbitrary wave. In a PM process, the carrier phase varies with the transient voltage of the modulation waveform. The UI for PM is illustrated below.

UI for Phase Modulation (PM)

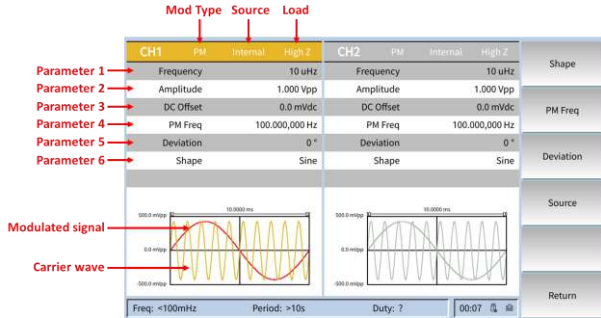

Setting procedure for PM

Steps

1. Successively press the function key **MOD** and **F4** to select **PM** as modulation type.
2. Press **Waveform** and the waveform and parameters of the current carrier will be displayed. You can change the carrier parameters. Refer to “Sine Wave Output” for more details. Press **MOD** again to go back to the Modulation Mode screen.
3. Press **F4** to select a signal source. If you select “External”, directly skip to Step (5) after the external signal source is connected to the **Ext Mod In** interface on the rear panel. If you select “Internal”, proceed the following procedure.
4. Press **F1** to select a type of “Shape “. You can choose Sine, Square, Triangle, Noise, or Arb.
5. Press **F2** to set the PM frequency. The range of PM frequency is 2 mHz to 1 MHz (only for internal signal sources).
6. Press **F3** to set the phase deviation (i.e., phase shift) within the range of 0° to 180°.

Pulse Width Modulation (PWM)

The output modulation waveform consists of carrier and modulating wave. The PWM function is valid for modulation of pulse waves only. Consequently, carriers can only be pulse waves. In a PWM process, the pulse width of a carrier (pulse wave) varies with the transient voltage of the modulation waveform.

UI for Pulse Width Modulation (PWM)

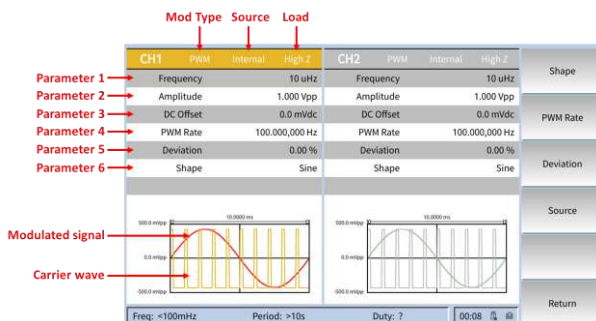

Setting procedure for PWM

Steps

1. First of all, set the "Carrier" to "Pulse Wave"; then press **MOD** to enter the PWM mode.
2. Successively press the function key **MOD** and **F5** to select PWM as modulation type.
3. Press **Waveform** and the waveform and parameters of the current carrier will be displayed. Press **MOD** again to go back to the Modulation Mode screen.
4. Press **F4** to select a signal source. If you select "External", directly skip to Step (6) after the external signal source is connected to the Ext Mod In interface on the rear panel. If you select "Internal", proceed the following procedure.
5. Press **F1** to select a type of "Shape". You can choose Sine, Square, Triangle, Noise, or Arb.

6. Press **F2** to set the PWM rate within the range of 2 mHz to 1 MHz (only for internal signal sources).
7. Press **F3** to set the deviation (in case of a non-modulation mode, the setting on the Pulse Wave menu is pulse width or PWM duty). The maximum range of duty cycle skew is 0 to Min. [Min is the smaller of the pulse wave duty cycle and the result of (100% - pulse wave duty cycle).]

Amplitude Shift Keying (ASK)

The output modulation waveform consists of carrier and modulating wave. A carrier may be a sine wave, square wave, triangle wave, or arbitrary wave. In an amplitude modulation process, the carrier amplitude varies with the transient voltage of the modulation waveform. The UI for ASK is illustrated below.

UI for Amplitude Shift Keying (ASK)

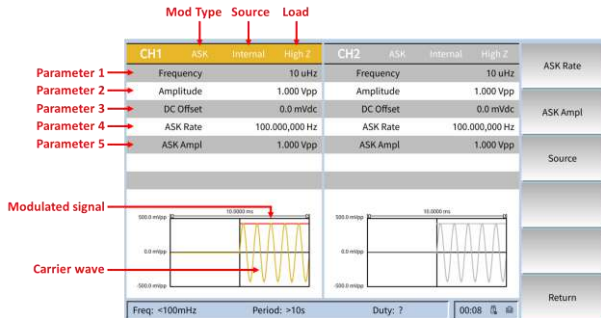

Setting procedure for ASK

- Steps
1. Successively press the function key **MOD**, **F6** and **F1** to select **ASK** as modulation type. Select a carrier waveform as needed. Take sine wave as an example.
 2. Press **Waveform** and the waveform and parameters of the current carrier will be displayed. You can change the carrier parameters. Refer to “Sine Wave Output” for more details. Press **MOD** again to go back to the Modulation Mode screen.
 3. Press the soft key **F3** to select a signal source. If you select “External”, directly skip to Step (5) after the external signal source is connected to the **Mod/FSK/Trig** interface on the rear panel. If you select “Internal”, proceed the following procedure.
-

**Note**

If you select “External” as signal source, set the slope to “Positive”. As a result, when a high logic level is input, the bigger of the carrier amplitude and the modulation amplitude will be output; when a low logic level is input, the smaller of the carrier amplitude and the modulation amplitude will be output. It is just the reverse in case of “Negative” slope.

- Steps
4. Press **F1** to set the **ASK Rate** within the range of 2 mHz to 1 MHz (only for internal signal sources).
 5. Press **F2** to set the **Amplitude** (i.e., modulation amplitude) within the range of 0 mVpp to Max (Max is the set carrier amplitude).

Phase Shift Keying (PSK)

The output modulation waveform consists of carrier and modulating wave. A carrier may be a sine wave, square wave, triangle wave, or arbitrary wave. In a PSK process, the carrier phase

varies with the transient voltage of the modulation waveform. The UI for PSK is illustrated below.

UI for Phase Shift Keying (PSK)

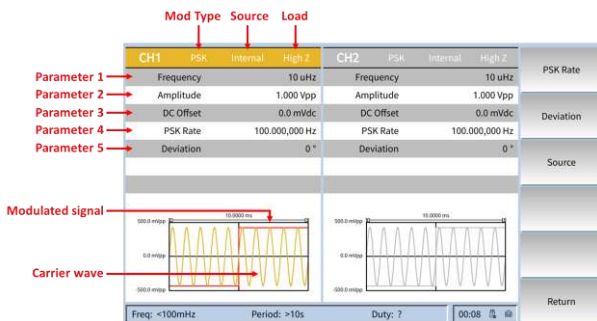

Setting procedure for PSK

Steps

1. Successively press the function key **MOD**, **F6** and **F2** to select **PSK** as modulation type. Select a carrier waveform as needed. Take sine wave as an example.
2. Press **Waveform** and the waveform and parameters of the current carrier will be displayed. You can change the carrier parameters. Refer to “Sine Wave Output” for more details. Press **MOD** again to go back to the Modulation Mode screen.
3. Press the soft key **F3** to select a signal source. If you select “External”, directly skip to Step (5) after the external signal source is connected to the Mod/FSK/Trig interface on the rear panel. If you select “Internal”, proceed the following procedure.



Note

If you select “External” as signal source, set the slope to “Positive”. As a result, when a low logic level is input, the carrier phase will be output; when a high logic level is input, the modulation phase will be output. It is just the reverse in case of “Negative” slope.

Steps

4. Press **F1** to set the PSK Rate within the range of 2 mHz to 1 MHz (only for internal signal sources).
5. Press **F2** to set the phase deviation within the range of 0° to 360°. The default value is 0°.

Frequency Shift Keying (FSK)

FSK is used to shift the output frequency between two preset frequencies (carrier frequency and hopping frequency). The specific frequency at which such output will shift between two frequencies depends on the internal frequency generator (internal signal source) or the signal level (external signal source) at the **Ext Trig/Burst/Fsk In** interface on the rear panel. A carrier may be a sine wave, square wave, triangle wave, or arbitrary wave. The UI for FSK is illustrated below.

UI for Frequency Shift Keying (FSK)

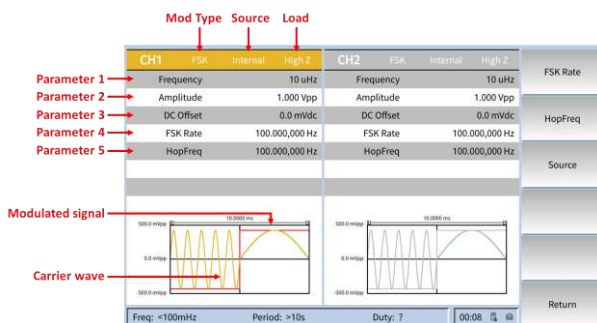

Setting procedure for FSK

Steps

1. Successively press the function key **MOD**, **F6**

and **F3** to select **FSK** as modulation type. Select a carrier waveform as needed. Take sine wave as an example.

2. Press **Waveform** and the waveform and parameters of the current carrier will be displayed. You can change the carrier parameters. Refer to “Sine Wave Output” for more details. Press **MOD** again to go back to the Modulation Mode screen.
3. Press the soft key **F3** to select a signal source. If you select “External”, directly skip to Step (5) after the external signal source is connected to the **Ext/Fsk/Trig** interface on the rear panel. If you select “Internal”, proceed the following procedure.



If you select “External” as signal source, set the slope to “Positive”. As a result, when a low logic level is input, the carrier frequency will be output; when a high logic level is input, the hopping frequency will be output. It is just the reverse in case of “Negative” slope.

Steps

4. Press **F1** to set the **FSK Rate** within the range of 2 mHz to 1MHz (only for internal signal sources).
5. Press **F2** to set the **Hopping Frequency** (i.e., alternate frequency).

Ternary Frequency Shift Keying (3FSK)

3FSK is used to shift the output frequency among three preset frequencies (“carrier frequency” and two “hopping frequencies”). The specific frequency at which such output will shift among three frequencies depends on the internal frequency generator (internal signal source). A carrier may be a sine wave, square wave, triangle wave, or arbitrary wave. The UI for 3FSK is illustrated below.

UI for Ternary Frequency Shift Keying (3FSK)

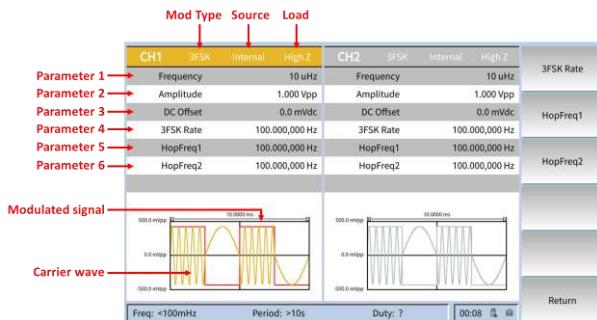

Setting procedure for 3FSK

Steps

1. Successively press the function key **MOD**, **F6** and **F4** to select **3FSK** as modulation type. Select a carrier waveform as needed. Take sine wave as an example.
2. Press **Waveform** and the waveform and parameters of the current carrier will be displayed. You can change the carrier parameters. Refer to “Sine Wave Output” for more details. Press **MOD** again to go back to the Modulation Mode screen.
3. Press **F1** to set the **3FSK Rate** within the range of 2 mHz to 1MHz.
4. Press **F2** or **F3** to select and set the **Hopping Frequencies** (i.e., alternate frequencies).

Quaternary Frequency Shift Keying (4FSK)

4FSK is used to shift the output frequency among four preset frequencies (“carrier frequency” and three “hopping frequencies”). The specific frequency at which such output will shift among four frequencies depends on the internal frequency generator (internal signal source). A carrier may be a sine wave, square wave, triangle wave, or arbitrary wave. The UI for 4FSK is illustrated below.

UI for Quaternary Frequency Shift Keying (4FSK)

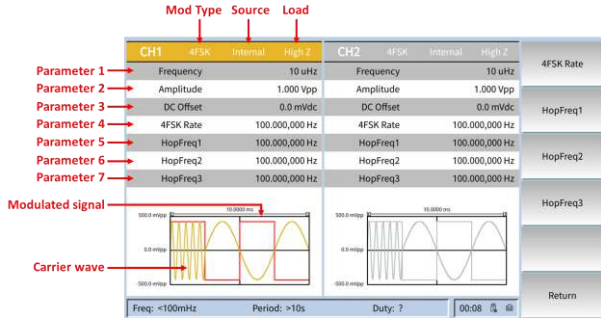

Setting procedure for 4FSK

Steps

1. Successively press the function key **MOD**, **F6**, **F5** and then **F1** to select **4FSK** as modulation type. Select a carrier waveform as needed. Take sine wave as an example.
2. Press **Waveform** and the waveform and parameters of the current carrier will be displayed. You can change the carrier parameters. Refer to “Sine Wave Output” for more details. Press **MOD** again to go back to the Modulation Mode screen.
3. Press **F1** to set the **4FSK Rate** within the range of 2 mHz to 1MHz.
4. Press **F2-F4** to select and set the **Hopping Frequencies** (i.e., alternate frequencies).

Binary Phase Shift Keying (BPSK)

BPSK is used to shift the output phase between the preset frequencies (“carrier phase” and “modulation phase”). The specific frequency at which such output will shift between two phases depends on the internal frequency generator (internal signal source). A carrier may be a sine wave, square wave, triangle wave, or arbitrary wave. The UI for BPSK is illustrated below.

UI for Binary
Phase Shift
Keying (BPSK)

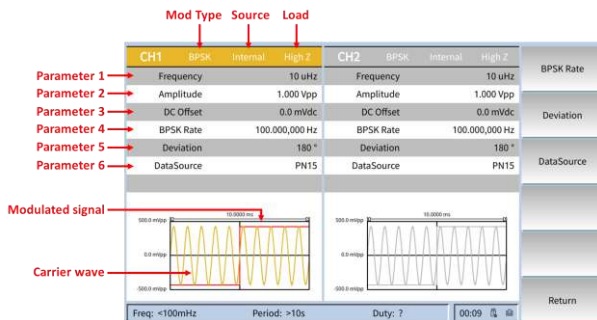

Setting procedure for BPSK

Steps

1. Successively press the function key **MOD**, **F6**, **F5** and then **F2** to select **BPSK** as modulation type. Select a carrier waveform as needed. Take sine wave as an example.
2. Press **Waveform** and the waveform and parameters of the current carrier will be displayed. You can change the carrier parameters. Refer to “Sine Wave Output” for more details. Press **MOD** again to go back to the Modulation Mode screen.
3. Press **F1** to set the Code Rate within the range of 2 mHz to 1MHz.
4. Press **F2** to select and set the phase deviation within the range of 0° to 360°.
5. Press **F3** to select and set the Data Source Code, which consists of Code 01, Code 10, Code PN15, and Code PN21.

Quadrature Phase Shift Keying (QPSK)

QPSK is used to shift the output phase between the preset frequencies (“carrier phase” and “modulation phase”). The specific frequency at which such output will shift between two phases depends on the internal frequency generator (internal signal

source). A carrier may be a sine wave, square wave, triangle wave, or arbitrary wave. The UI for QPSK is illustrated below.

UI for Quadrature Phase Shift Keying (QPSK)

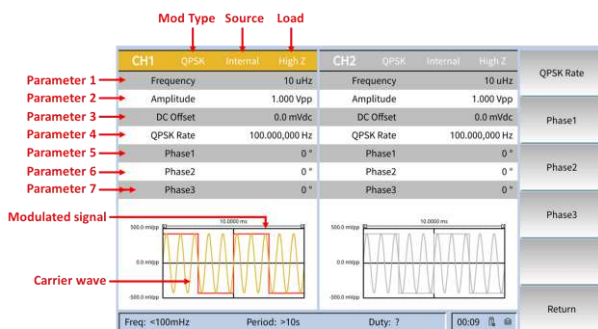

Setting procedure for QPSK

Steps

1. Successively press the function key **MOD**, **F6**, **F5** and then **F3** to select **QPSK** as modulation type. Select a carrier waveform as needed. Take sine wave as an example.
2. Press **Waveform** and the waveform and parameters of the current carrier will be displayed. You can change the carrier parameters. Refer to “Sine Wave Output” for more details. Press **MOD** again to go back to the Modulation Mode screen.
3. Press **F1** to set the **Rate** within the range of 2 mHz to 1MHz.
4. Press **F2-F4** to select and set the phase deviation within the range of 0° to 360°.

Oscillation Shift Keying (OSK)

The output modulation waveform consists of carrier and modulating wave. Carriers can only be sine waves. In an OSK process, the carrier phase varies with the keying frequency of the modulation waveform. The UI for OSK is illustrated below.

UI for Oscillation
Shift Keying
(OSK)

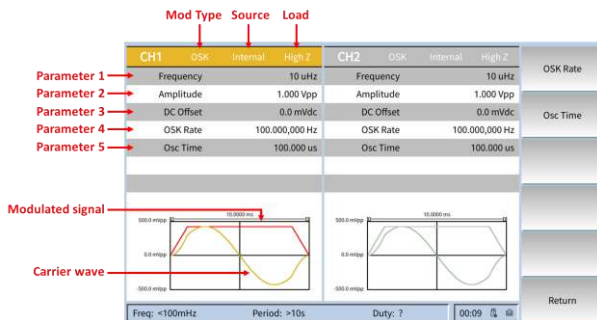

Setting procedure for OSK

Steps

1. Successively press the function key **MOD**, **F6**, **F5** and then **F4** to select **OSK** as modulation type. Select a carrier waveform as needed. Take sine wave as an example.
2. Press **Waveform** and the waveform and parameters of the current carrier will be displayed. You can change the carrier parameters. Refer to "Sine Wave Output" for more details. Press **MOD** again to go back to the Modulation Mode screen.
3. Press **F1** to set the Keying Frequency within the range of 2 mHz to 1MHz.
4. Press **F2** to select and set the Duration of Oscillation within the range of 8 ns to 249.99 s.

SUM Modulation (SUM)

The output modulation waveform consists of carrier and modulating wave. In a SUM modulation process, the carrier amplitude varies with the transient voltage of the modulation waveform. The UI for SUM is illustrated below.

UI for SUM
Modulation
(SUM)

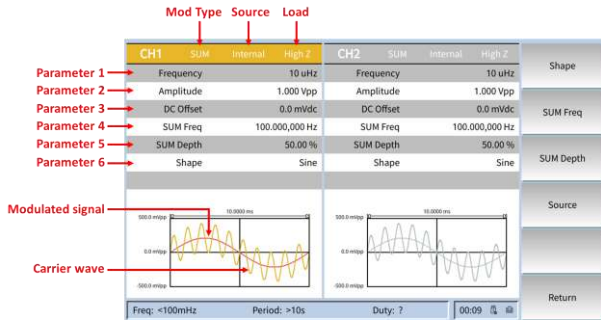

Setting procedure for SUM

Steps

1. Successively press the function key **MOD**, **F6**, **F5** and then **F5** again to select **SUM** as modulation type. Select a carrier waveform as needed. Take sine wave as an example.
2. Press **Waveform** and the waveform and parameters of the current carrier will be displayed. You can change the carrier parameters. Refer to “Sine Wave Output
3. “for more details. Press **MOD** again to go back to the Modulation Mode screen.
4. Press **F4** to select a signal source. If you select “External”, the setting procedure will be completed after the external signal source is connected to the **Ext Mod In** interface on the rear panel. If you select “Internal”, proceed the following procedure.
5. Press **F1** to select “Shape”. You can choose **Sine**, **Square**, **triangle**, **Noise** or **Arb** .
6. Press **F2** to set the modulation frequency. The range of modulation frequency is 2 mHz to 1 MHz (only for internal signal sources).
7. Press **F3** to set the modulation depth. The modulation depth range is 0% to 100%.

Sweep Frequency Output

In the sweep mode, the frequency output will vary with the sweep type from the start frequency to the stop frequency within the specified sweep time. Only sine waves, square waves, triangle waves or arbitrary waves can be used to generate sweep signals.

UI for Sweep Mode

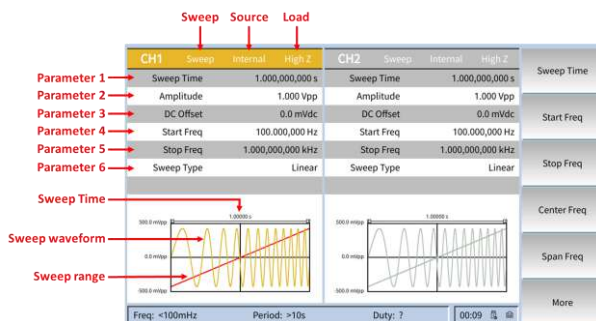

Setting procedure for the sweep mode:

Steps

1. In the UI for sine wave, square wave, triangle wave, or arbitrary wave, press the function key **Sweep** to enter the sweep mode.
2. You can select a sweep waveform by pressing **Waveform**. For instance, if you select "Sine", the sweep waveform and parameters can be displayed after you press **Waveform**, and then you can change parameters.
3. Press **F1** to set the sweep time, which is the required duration (unit: ms or s) when the frequency changes from the start frequency to the stop frequency, within the range of 1ms to 500s.
4. Successively press **F6** and **F1** to switch the sweep type. If **Linear Sweep** is selected, the output frequency will show linear changes within the sweep time. If **Logarithmic Sweep** is selected, the output frequency will show

logarithmic changes. If Stepping is selected, you are free to a step count.

5. Press **F2** to set a Start Frequency value. Refer to Table 1 for details.
6. Press **F3** to set a Stop Frequency value. Refer to Table 1 for details.
7. Press **F4** to set a Center Frequency value. Refer to Table 1 for details.
8. Press **F2** to set a Frequency Range value. Refer to Table 1 for details.

Parameter value Waveform type	Sine wave	Square wave	triangle wave	Arbitrary wave Output
Minimum start/ stop frequency	1 uHz			
Maximum start/ stop frequency	250 MHz	50 MHz	5 MHz	15 MHz (built-in waveform) 25 MHz (user-defined waveform)

- Steps
1. Successively press **F6** and **F2** to select a trigger source. “**Internal**” means that an internal signal source will be used. “**External**” means that an external signal source which uses the Mod/FSK/Trig interface on the rear panel will be used. In case of external signal source, you can choose “Positive/Negative” (“Positive”: an option for outputting trigger signals during rising; “Negative”: an option for outputting trigger signals during falling) after pressing “Slope”. “**Manual**” means an option for manual triggering; once **Trigger** on the front panel is pressed on the sweep frequency screen, the sweep function will be activated.

Burst Waveform Output

After the function key **Burst** is pressed, bursts will be generated and thus the Burst waveforms of multiple waveform functions can be output. A Burst can persist for a specific number of waveform cycles (Burst for N cycles), or will be controlled by external gating signals (Bursts for gating). The function for sine wave, square wave, triangle wave, pulse wave, noise wave, or arbitrary wave can be used (this function cannot be used for harmonic waves).

Glossary

Burst:

refers to a set of pulses transmitted together. It is generally called the BURST function in various signal generators.

Burst for N Cycles:

consists of a specific number of waveform cycles, and each Burst is activated by a trigger event.

Burst for Gating:

External gating signals are used to control waveforms as well as when the activity of a Burst waveform will occur.

Set the Burst for N cycles

UI for the Burst
for N Cycles

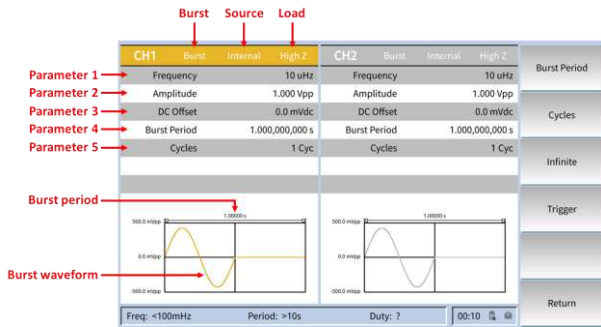

Steps

1. In the UI for sine wave, square wave, triangle wave, pulse wave, noise wave or arbitrary wave, after the function key **Burst** is pressed, bursts will be generated.
2. You can select waveform functions by pressing **Waveform**. For instance, if you select “Sine” (sine wave), the waveform and parameters can be displayed after you press **Waveform**, and then you can change parameters. Refer to “Sine Wave Output” for more details. You can go back to the Burst mode screen by pressing **Burst**.



Note

Select a channel for configuration before configuring waveform parameters. You can select the corresponding channel by pressing **CH1/CH2**. The corresponding channel area in the UI will become brighter.

3. Press **F1** to select the N Cycles.
4. Press **F1** to set the Burst Period within the range of 20ns to 500s (Min = Cycles * Period).
5. Press **F2** to set the Cycle Number (i.e., the number of waveform cycles to be output for each Burst for N cycles). The range is 1-

1,000,000 cycles. If you choose “Unlimited”, a continuous waveform will be output until a trigger event is received.

**Note**

In the Burst mode, the upper limit of the carrier frequency will be half of the original maximum carrier frequency. Take sine wave as an example. The maximum carrier frequency is 200 MHz. After you press **Waveform** to set the carrier frequency to 200 MHz, and successively press the soft key Burst, **Waveform**, or Burst again, you can see that the original carrier frequency will change to 100 MHz.

Tip

- The burst period should increase to adapt to the specified number of cycles, if necessary.
 - For an unlimited number of Bursts, an external or manual trigger source is required to activate Bursts (except for internal trigger source).
6. Press **F4** to select a trigger source. “Internal” means that an internal signal source will be used. “External” means that an external signal source which uses the **Ext/Fsk/Trig** interface on the rear panel will be used. In case of external signal source, you can choose “Positive/Negative” (“Positive”: an option for outputting trigger signals during rising; “Negative”: an option for outputting trigger signals during falling) after pressing “Slope”. “Manual” means an option for manual triggering. In the UI for the Burst for N cycles, once **Trigger** for the current channel on the front panel is pressed, a Burst will be output.

Set the Burst for gating

UI for the Burst
for Gating

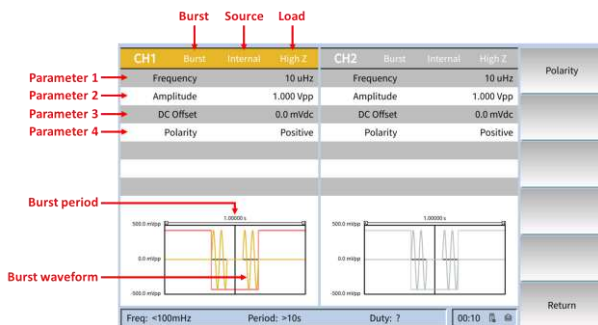

Steps

1. In the UI for sine wave, square wave, triangle wave, pulse wave or arbitrary wave, press the function key **Burst**.
2. You can select waveform functions by pressing **Waveform**. For instance, if you select “Sine” (sine wave), the waveform and parameters can be displayed after you press **Waveform**, and then you can change parameters. Refer to “Sine Wave Output” for more details.



Note

Select a channel for configuration before configuring waveform parameters. You can select the corresponding channel by pressing CH1/CH2. The corresponding channel area in the UI will become brighter.

1. Press **F2** to select “Gating”.
2. You can choose “Positive” or “Negative” gating signals by pressing **F1**. The default setting is “Positive”. The polarity for gating is applicable to the Burst mode for gating only. When the gating signal of the instrument at the [Mod/FSK/Trig] connector on the rear panel is a “High Level” or “Low Level”, Bursts will be output.

Frequency Counter

The frequency counter is designed to measure the signals within the frequency range of 100 mHz to 200 MHz. The [10MHz In/Out/Counter] connector on the rear panel is used to receive signals from the frequency counter by default. The frequency counter will keep operating after startup, until the connector is set to the external clock input or clock output.

UI for the Frequency Counter

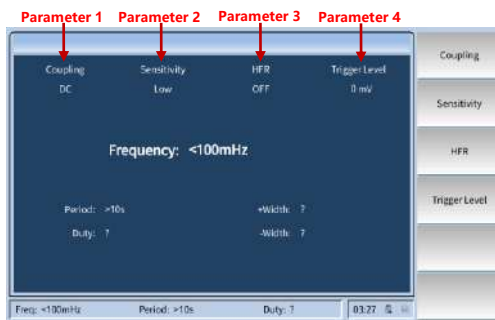

Steps

1. Press the function key **Counter** on the front panel to enter the frequency counter screen.
2. Connect the signal to be measured to the [10MHz In/Out/Counter] connector on the rear panel.
3. Set the frequency counter:
 - Press **F1** to select "Coupling". Then press **F1** or **F2** to shift between AC or DC, and set the coupling mode of input signals.
 - Press **F2** to select "Sensitivity". Then press **F1-F3** to shift High/Media/Low. For signals with small amplitude, select "Media" or "High" for their sensitivity. For low- frequency signals with large amplitude or those with slow rising edge, select "Low" for their sensitivity. In this way, the measurements will be more accurate.

- Press **F3** to select “HF Rejection”. Then press **F1** or **F2** to switch it **ON** or **OFF**. HF rejection is designed to filter high frequency components (HFC) during measurement of low-frequency signals for more accurate measurements. If you want to measure low-frequency signals with the frequency less than 1 kHz, switch on HF rejection to eliminate the high-frequency noise interference. If you want to measure high-frequency signals with the frequency larger than 1 kHz, switch off HF rejection.
 - Press **F4** to select “Trigger Level”. Turn the **knob** to change the current digit indicated by the cursor. Move the cursor side to side by pressing the direction keys; alternatively, use the **numeric keypad** to enter the value. Next, select the desired unit from the menu on the right side. The range of trigger level is -2.5 V to 2.5 V. After setting is completed, the frequency counter will measure those signals based on the current settings. If readings are unstable, repeat the adjustment procedure above until the indications become stable.
4. Frequency, duty cycle, positive PW and negative PW are visible on the frequency counter screen.

Utility Settings

Press the function key **Utility** to enter the System Options menu. The user can set the display parameters, CH1/CH2 settings, interface settings and system parameters of the signal generator. Press **Utility** again to exit the System Options menu.

UI for the Utility



Display Settings

Backlight

Steps

1. Press the function key **Utility**. Press **F1** to select "Display". Press **F1** again to select "Backlight".
2. Turn the **knob** to change the current digit indicated by the cursor. Move the cursor side to side by pressing the direction keys **←/→**; alternatively, use the **numeric keypad** to enter the brightness value (%). The brightness range is 0% to 100%.

Screen Saver

If there is no action within the preset screen saver time, the screen will enter the screen saver mode (the screen will deactivate, i.e., "Blank Screen"). The operation interface can be displayed again after any key is pressing.

Steps

1. Press the function key **Utility**. Press **F1** to select "Display". Press **F2** to select "Screen Saver". Then choose to switch it **ON/OFF**.
2. When the screen saver is switched ON, you can set the screen saver time. Turn the **knob** to

change the current digit indicated by the cursor. Move the cursor side to side by pressing the direction keys **◀**/**▶**; alternatively, use the **numeric keypad** to enter the screen saver time in minute. The range of the screen saver time is 1 to 60 minutes.

Separator

The user can set the separator for the data to be displayed on the screen.

- Steps
1. Press the function key **Utility**. Press **F1** to select "Display". Press **F3** to select a separator.
 2. After **F1-F3** is pressed, the separator can be switched among comma, space and none.

Take the frequency parameter value as an example:

Comma	1.000,000
Space	1.000 000
None	1.000000

CH1/CH2 Settings

- Steps
1. Press the function key **Utility**. Press **F2** to select "CH1/CH2 Settings".
 2. Press **F1** to select "CH1 Synchronization". Press **F1** to enable synchronization. Press **F2** to disable synchronization.
 3. Press **F2** to select "CH2 Synchronization". Press **F1** to enable synchronization. Press **F2** to disable synchronization.

Dual CH Settings

- Steps
1. Press the function key **Utility**. Press **F3** to

- select "Dual CH".
2. After entering the Dual CH Settings screen, you can set the frequency coupling, amplitude coupling and tracking.
 3. Press **F1** to set the frequency coupling. Press **F1** or **F2** to switch it ON/OFF.
 4. Press **F2** to set the amplitude coupling. Press **F1** or **F2** to switch it ON/OFF.
 5. Press **F3** to set the tracking. Press **F1-F3** to switch it ON/OFF, or invert it.

I/O Settings

Steps

1. Press the function key **Utility**. Press **F4** to select "I/O Settings". Press **F1** to enter the next menu.
2. Press **F1** to automatically acquire the IP address of the instrument.
3. Press **F2** to manually configure the IP address. Such settings contain the IP address, netmask and gateway. The physical address displayed on the screen cannot be modified. After the user defines the network parameter settings of the signal generator such as IP address, the user has to wait for more than 2s and reboot the machine in order to make them effective.
 - Press **F1** to select the "IP Address". Use the numeric keypad and knob to enter the desired IP address. Its format is nnn.nnn.nnn.nnn; wherein the range of the first "nnn" is 1 to 223 (except 127), and that of the remaining three "nnn" is 0 to 255. You are kindly advised to consult your network administrator for an available IP address.
 - Press the soft key **F2** to select the

“Netmask”. Use the numeric keypad and knob to enter the desired netmask address. The format of the default netmask is nnn.nnn.nnn.nnn; wherein the range of “nnn” is 0 to 255. You are kindly advised to consult your network administrator for an available IP address.

- Press **F3** to select the “Gateway”. Use the numeric keypad and knob to enter the desired gateway address. The format of the default gateway is nnn.nnn.nnn.nnn; wherein the range of the first “nnn” is 1 to 223 (except 127), and that of the remaining three “nnn” is 0 to 255. You are kindly advised to consult your network administrator for an available IP address.

System Settings

Language

Press the function key **Utility**. Press **F5** to select “System Settings”. Press **F1** to switch the display language.

Beeper

Press the function key **Utility**. Press **F5** to select “System Settings”. Press **F2** to switch ON or OFF the beeper.

Clock Reference

The internal clock reference is available. An external clock reference from **[10MHz In/ Out/ Counter]** on the rear panel is also acceptable. Moreover, a clock reference can be output by the **[Ref Clk Out]** connector for the use by other devices.



The amplitude of signals from **[10MHz In/Out/Counter]** must be larger than 1 V.

Press the function key **Utility**. Press **F5** to select “System Settings”. Press **F3** to select the Clock Reference, and press this soft key again to switch “Internal/External”.

**Note**

The internal clock reference is the “Clock Reference” by default. When an external clock reference is required, switch to “External”, and then the source of the clock reference will be switched off;

You must switch the “Clock Reference” to “Internal” before switching on the clock reference output option. After the clock output is switched on, the frequency counter function will be disabled.

Clock Output

Press the function key **Utility**. Press **F5** to select “System Settings”. Press **F4** to select the “Clock Output”; click the “Clock Output” menu and press this soft key again to switch “ON/OFF”.

Date

Press the function key **Utility**. Press **F5** to select “System Settings”. Next, successively press **F5** and **F1** to select the “Date”. Turn the **knob** to change the current digit indicated by the cursor. Move the cursor side to side by pressing the direction keys **◀** / **▶**.

Upgrade

Press the function key **Utility**. Press **F5** to select “System”.

Insert the USB storage device to the USB connector on the front panel of the instrument.

**Note**

If no USB storage device is inserted, the “Firmware Upgrade” menu will be disabled.

Press **F5** to select “More”. Press **F2** to select “Upgrade”. After that, the instrument will automatically identify whether an upgrade package is available. If yes, automatic upgrade will be performed.



Note

If the firmware upgrade fails, the error code will appear. Error codes and messages are provided in Table 2.

Table 2

Error code	Error message
2	The file size is too large.
3	An error occurs while the firmware file is read.
4	An error occurs while the firmware file is verified.
5	The firmware type flag is incorrect.
6	The instrument version cannot be upgraded to the firmware file version.
7	The instrument model does not match that specified in the firmware file.

Save/Recall

The instrument settings can be stored as files in the internal memory or an external USB storage device. The internal memory of the instrument can store up to 16 instrument settings. If you want to store more settings, please use a USB storage device. For any settings file stored in the USB storage device, please use the extension “CFG”. You can restore the settings already stored from the files in the internal memory or USB storage device.

UI for the Save/Recall

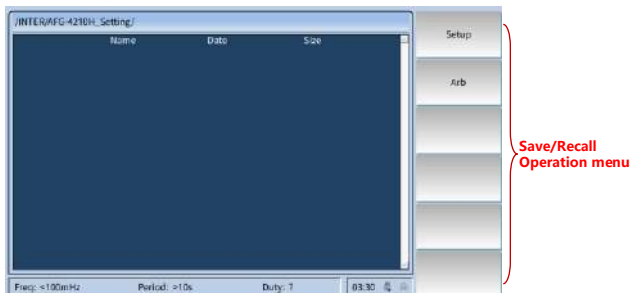

Operation Procedure

Press the function key **Save/Recall** on the front panel to enter the Save/Recall menu. Press **F1** to enter the setup interface.

- If you want to store the settings in the internal memory, you have to press **F1** to choose “Media” and then press **F1** again to choose “Internal”. Press **F6** to go back to the main Save/Recall menu. Press **F2** to choose “New”. Enter a file name. Finally, press **F1** to complete the storage procedure. (The file size is indicated on the right side of the file. If 0B is displayed, it means that this is an empty file.)



Note

- You can overwrite any files already selected by pressing F3.
 - You can recall settings by selecting the desired file and then pressing F4.
 - By pressing F5, you can delete the files already selected in the internal memory.
-
- If you want to store settings in a USB storage device, you have to insert it to the USB interface on the front panel. Press **F1** to select “Media”. Press **F2** to select “USB Device”. Press **F6** to go back to the main Save/Recall menu. Press **F2** to choose “New”. Enter a file name. Finally, press **F1** to complete the storage procedure. Press the function key **Save/Recall** on the front panel to enter the Save/Recall menu. Press **F2** to enter the UI for arbitrary wave.
 - If you want to recall any arbitrary wave stored in the internal memory, just press **F1** to choose “Media” and then press **F1** again to choose “Internal”. Press **F6** to go back to the main Save/Recall menu. Press **F2** to recall the

arbitrary wave.

- If you want to recall any arbitrary wave stored in the USB storage device, just press **F1** to choose “Media” and then press **F2** to choose “USB Device”. Press **F6** to go back to the main Save/Recall menu. Press **F2** to recall the arbitrary wave.



Note

You can delete any files already selected by pressing F3.

Set to the Factory Defaults (Preset)

Press the function key **Preset**. Press **F1** to restore the instrument settings to the factory defaults. The factory default parameters are listed below:

Output configuration	Factory defaults
Signal output switch for CH1	OFF
Signal output switch for CH2	OFF
Function	Sine wave
Frequency	1.000 000 000 kHz
Amplitude/offset	1.000 Vpp/0.0 mVdc

Waveform configuration	Factory defaults
Frequency	1.000 000 000 kHz
Amplitude	1.000 Vpp
Offset	0.0 mVdc
Initial phase	0deg
Symmetry	50.00%
Pulse Width	500.000 us
Duty cycle	50.00%
Lead time	1.953 us
Trail time	1.953 us
Harmonic wave type	Even harmonics
Total count of harmonic waves	2
Harmonic order number	2

Harmonic amplitude	1.000 Vpp
Harmonic phase	0deg

Modulation waveform	Factory defaults
Modulation type	AM
Modulation waveform	Sine wave
AM frequency	100.000 000 000 Hz
Modulation depth	100.00%
Signal source	Internal
Modulation frequency	100.000 000 000 Hz
Frequency shift	100.000 000 Hz
PM frequency	100.000 000 Hz
Phase deviation	0deg
PWM rate	100.000 000 Hz
Duty cycle skew	0.00%
ASK rate	100.000 000 Hz
ASK amplitude	1.000 Vpp
PSK rate	100.000 000 Hz
Phase deviation for PSK	0deg
FSK rate	100.000 000 Hz
Hopping Frequency	100.000 000 Hz
Hopping Frequency 1	100.000 000 Hz
Hopping Frequency 2	100.000 000 Hz
Hopping Frequency 3	100.000 000 Hz
Code Rate	100.000 000 Hz
Phase deviation for BPSK	180deg
Data source	Code PN15
Keying frequency	100.000 000 Hz
Duration of Oscillation	100.000 us

Sweep	Factory defaults
Sweep time	1.000 000 000 s
Sweep mode	Linear sweep
Start frequency	100.000 000 Hz
Stop frequency	1.000 000 000 kHz
Center frequency	550.000 000 Hz
Frequency range	900.000 000 Hz
Trigger source	Internal

Slope	Positive
-------	----------

Burst	Factory defaults
Trigger interval	1.000 000 000 s
Burst mode	N cycles
Cycle number	1
Trigger source	Internal
Slope	Positive
Polarity	Positive

Frequency counter	Factory defaults
Coupling	DC
Sensitivity	Low
HF rejection	OFF
Trigger level	0 mV

Utility	Factory defaults
Backlight	50.00%
Screen saver	ON
Screen saver time	30 minutes
Separator	Space
CH1 synchronization	OFF
CH2 synchronization	OFF
CH1 loading	High impedance
CH2 loading	High impedance
IP Address	192.168.001.100
Gateway	192.168.001.001
Netmask	255.255.255.000
Language	Please refer to the actual machine received.
Beeper	ON
Clock reference	Internal

Channel (CH1/CH2) Function Settings

Set the load value

For each output terminal of two channels on the front panel, the signal generator provides a 50 Ω constant output impedance in series. If the actual load impedance differs from the specified value, neither the amplitude nor the level for shift displayed will match the voltage level of the unit under test (UUT). The load impedance setting is provided herein to help the user match the displayed voltage with the desired load.

Setting procedure for CH1 or CH2 load value

- Steps
1. Press the function key **CH1/CH2** to enter "CH1/CH2 Settings".
 2. Press **F1** to select a load. Press **F1** or **F2** to switch to 50 ohm or High Impedance. Press **CH1/CH2** on the front panel to switch the channel.

Tip

Each output terminal on the front panel has a 50 Ω constant output impedance in series. If the actual load differs from the specified value, the displayed voltage level will not match the actual level, regardless of which value has been specified for this parameter.

Sync Int

Our instrument can output the synchronization signals of fundamental waves (except noise), arbitrary waves (except DC), harmonic waves, sweep waves, Burst waveforms, and modulation waveforms via a single channel or simultaneously via two channels. Such signal is output from the **Sync Int** connector on the front panel.

Steps

1. **Synchronous switching**

Enable or disable the synchronization signals from the [Sync Int] connector. Press **Utility** to set "CH1 Synchronization/CH2 Synchronization". Choose to switch "ON" or "OFF" the the synchronization signal output. It remains "OFF" by default. Synchronization signals will be sent to the [Sync Int] connector. When synchronization signals are switched off, the output level at the [Sync Int] connector is a low logic level.

2. **Synchronization signals of various waveforms**

- For sine wave, square wave, triangle wave, and pulse wave, synchronization signals are square waves with the duty cycle of 50%. When a waveform output is positive, in comparison with 0 V voltage (or DC offset value), synchronization signals will be high levels of the TTL. When a waveform output is negative, in comparison with 0 V voltage (or DC offset value), synchronization signals will be low levels of the TTL.
- For arbitrary waves, synchronization signals are square waves with variable duty cycle. When the output waveform amplitude reaches a specific value, synchronization signals will be high levels of the TTL.
- For harmonic waves, synchronization signals are based on the harmonic order and are square waves with variable duty cycle. When the output waveform amplitude is positive, synchronization signals will be high levels of the TTL.
- For AM, FM, PM and PWM, synchronization signals are based on the

modulation frequency during internal modulation and are square waves with the duty cycle of 50%. In the first half period of the modulation waveform, synchronization signals will be high levels of the TTL. During external modulation, no synchronization signal will be output.

- For ASK, FSK, PSK, BPSK, 3FSK and 4FSK, synchronization signals are based on the keying frequency and are square waves with the duty cycle of 50%. During external modulation, no synchronization signal will be output.
- For OSK, synchronization signals are based on the keying frequency and are square waves with the duty cycle of 50%. During oscillation starting of the internal crystal oscillator, synchronization signals will be high levels of the TTL.
- For a Burst for N cycles, when the Burst starts, synchronization signals will be high levels of the TTL. At the point where a specified number of cycles ends, synchronization signals will be low levels of the TTL (if the waveform has a related initial phase, it may not be the zero crossing). For an unlimited number of pulse bursts, their synchronization signals are the same as those of continuous waveforms.
- For Bursts for external gating, synchronization signals will follow their gating signals.



Note

Such signal will not become the low level of TTL until the last period ends (if the waveform has a related initial phase, it may not be the zero crossing).

Remote Control

Establishing a Remote Connection

AFG-4000 has 2 remote communication interfaces which are USB and LAN. These two communication modes can be used simultaneously.

Using the USB Interface

Description	Communication via USB interface, using USB Device TMC mode.	
Interface	Connect the USB cable to the rear panel USB B (slave) port.	DEVICE 
Connection and operation	<ol style="list-style-type: none"> 1. Use the USB cable to connect the USB Device Interface on the rear panel of the signal generator to the USB interface of the PC. 2. To use USB communication, you need to use the "NI Visa" software of NI (National Instruments Corporation); 3. After connecting to the host computer through the USB slave interface on the rear panel, open the "NI Visa" software, as shown in the figure above, select View -> Refresh in the menu bar of Measurement & Automation Explorer, when the connection is successful, click on the drop-down arrow of "Devices and Interfaces" in "My System" menu, the serial number of AFG-4000 and the USB Interface number will be displayed on the right side of the page. 	



Function Measurement

Click the "Open VISA Test Panel" key on the page to pop up the VISA Test Panel, click the Input/Output key in the VISA Test Panel, in the Select or Enter Command box, you can execute all statements including query, setting, measurement, reading and etc. When requiring to query, enter the corresponding query Command and then click the "Query" key to run the Command. Enter the corresponding Command when requiring to operate setting and measurement action and then click the "Write" key. Enter the corresponding Command when requiring to operate reading action and then click the "Read" key. Refer to Command List.

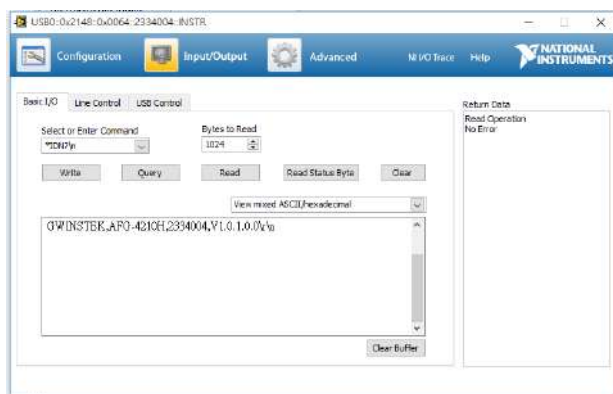

Enter the query Command “*IDN?” as shown above, and the instrument identification information such as manufacturer, model, serial number and software version will be returned. The message "Read Operation No Error" is displayed in the Return Data window.

Exit remote control mode .Send System:Loacl Command from PC.

! **NOTE: USB is a hot-swap device, which can be disconnected or connected at any time.**

Using the LAN Interface

Direct connection

Description When using the LAN interface, set the relevant parameters on the front panel.

Interface Connect the LAN cable to the rear panel LAN port.



Parameter settings

Interface:	LAN
Lan Boot Mode:	Manual
IP Address:	192.168.000.101
NetMask:	255.255.255.000
GateWay:	192.168.000.001
Mac Address:	98-89-24-52-A6-6C
Host Name:	AFG

Parameter description Mode: Choose DHCP (obtain IP address automatically) or Manual (set IP address manually);

IP Address: ranging from 1.0.0.0 to 223.255.255.255; (excluding 127.nnn.nnn.nnn);

Subnet Mask: ranging from 1.0.0.0 to 255.255.255.255;

Gateway: ranging from 1.0.0.0 to 223.255.255.255 (excluding 127.nnn.nnn.nnn);

Exit remote control mode .Send System:Local Command from PC

! **WARNING: LAN is a hot-swap device, which can be disconnected or connected at any time.**

SPECIFICATIONS

Specifications

This chapter lists the technical specifications and general technical specifications of the function generator. Unless otherwise stated, the technical specifications apply to the following conditions:

- The instrument has been preheated for 60 minutes before use.
- The instrument is in the calibration cycle and has been self-calibrated.

“Typical” and “nominal” for this product are defined as follows:

- Typical: Refers to the performance of the product under certain conditions.
- Nominal: Refers to the approximate value under product application process.

Waveform

Standard waveform	Sine, Square, Triangle, Pulse, Noise, Arbitrary, Harmonic	
Channel number	AFG-4125E	1
	AFG-4125AE	
	AFG-4225E	2
	AFG-4235	
	AFG-4260	
	AFG-4280	
	AFG-4210H	
	AFG-4225H	

Arbitrary		
Arbitrary Function	Built-in	
Sampling rate (user-editable sampling rate range from 2 μ Sa/s to 62.5MSa/s)	AFG-4125E	125 MSa/s
	AFG-4125AE	
	AFG-4225E	
	AFG-4235	500 MSa/s
	AFG-4260	
	AFG-4280	
	AFG-4210H	
	AFG-4225H	
Repetition Rate	AFG-4125E	15 MHz
	AFG-4125AE	
	AFG-4225E	
	AFG-4235	30 MHz
	AFG-4260	
	AFG-4280	
	AFG-4210H	
	AFG-4225H	
Waveform Length	AFG-4125E	2 to 16K points
	AFG-4125AE	
	AFG-4225E	2 to 10M points
	AFG-4235	
	AFG-4260	
	AFG-4280	
	AFG-4210H	
	AFG-4225H	
Amplitude Resolution	AFG-4125E	14 bits
	AFG-4125AE	
	AFG-4225E	
	AFG-4235	16 bits
	AFG-4260	
	AFG-4280	
	AFG-4210H	
	AFG-4225H	

Minimum rise and fall time	AFG-4125E	<10 ns
	AFG-4125AE	
	AFG-4225E	
	AFG-4235	<8 ns
	AFG-4260	
	AFG-4280	
	AFG-4210H	
	AFG-4225H	<5 ns
Jitter	AFG-4125E	8 ns
	AFG-4125AE	
	AFG-4225E	
	AFG-4235	
	AFG-4260	
	AFG-4280	
	AFG-4210H	
	AFG-4225H	
Non-volatile memory	32 MB	
User-defined output section	AFG-4125E	2 to 16384 points
	AFG-4125AE	
	AFG-4225E	2 to 10,240,000 points
	AFG-4235	
	AFG-4260	
	AFG-4280	
	AFG-4210H	
	AFG-4225H	
User-defined output marker segment	AFG-4125E	2 to 16384 points
	AFG-4125AE	
	AFG-4225E	2 to 10,240,000 points
	AFG-4235	
	AFG-4260	
	AFG-4280	
	AFG-4210H	
	AFG-4225H	

Frequency characteristics

Frequency resolution: 1 μ Hz or 10 significant figures;

Frequency error: ± 1 ppm;

Frequency aging rate: ± 1 ppm per year.

Sine	AFG-4125E	25 MHz
	AFG-4125AE	
	AFG-4225E	
	AFG-4235	35 MHz
	AFG-4260	60 MHz
	AFG-4280	80 MHz
	AFG-4210H	100 MHz
	AFG-4225H	250 MHz
Square	AFG-4125E	5 MHz
	AFG-4125AE	
	AFG-4225E	
	AFG-4235	15 MHz
	AFG-4260	30 MHz
	AFG-4280	
	AFG-4210H	
	AFG-4225H	50 MHz
Pulse	AFG-4125E	5 MHz
	AFG-4125AE	
	AFG-4225E	
	AFG-4235	15 MHz
	AFG-4260	25 MHz
	AFG-4280	
	AFG-4210H	
	AFG-4225H	
Triangle	AFG-4125E	1 MHz
	AFG-4125AE	
	AFG-4225E	
	AFG-4235	3 MHz
	AFG-4260	
	AFG-4280	
	AFG-4210H	
	AFG-4225H	5 MHz
	AFG-4125E	25 MHz BW

Noise(-3dB)	AFG-4125AE	
	AFG-4225E	
	AFG-4235	35 MHz BW
	AFG-4260	60 MHz BW
	AFG-4280	80 MHz BW
	AFG-4210H	100 MHz BW
	AFG-4225H	120 MHz BW
Harmonic	AFG-4125E	
	AFG-4125AE	12.5 MHz
	AFG-4225E	
	AFG-4235	17.5 MHz
	AFG-4260	30 MHz
	AFG-4280	40 MHz
	AFG-4210H	50 MHz
frequency stability	AFG-4125E	
	AFG-4125AE	
	AFG-4225E	
	AFG-4235	±2 ppm at 25°C±5°C
	AFG-4260	
	AFG-4280	
	AFG-4210H	
	AFG-4225H	±1 ppm at 0°C -40°C

Amplitude characteristics (not specifically marked, the default load is 50Ω)

Output amplitude	AFG-4125E	1mVpp to 10Vpp (≤ 25MHz,
	AFG-4125AE	into 50Ω. 2mVpp to 20 Vpp
	AFG-4225E	open-circuit)
	AFG-4235	1mVpp to 5Vpp (≤ 60MHz,
	AFG-4260	into 50Ω. 2mVpp to 10 Vpp
	AFG-4280	open-circuit)
	AFG-4210H	1mVpp to 2.5Vpp (≤ 100MHz ,
	AFG-4225H	into 50Ω. 2mVpp to 5 Vpp
		open-circuit)

		<p>1mVpp to 5Vpp ($\leq 80\text{MHz}$, into 50Ω. 2mVpp to 10 Vpp open-circuit)</p> <p>1mVpp to 2.5Vpp ($\leq 120\text{MHz}$, into 50Ω. 2mVpp to 5 Vpp open-circuit)</p> <p>1mVpp to 1Vpp ($\leq 250\text{MHz}$, into 50Ω. 2mVpp to 2 Vpp open-circuit)</p>
Bandwidth flatness	AFG-4125E	<p>$\leq 10\text{MHz}$: $\pm 0.2\text{dB}$</p> <p>$\leq 60\text{MHz}$: $\pm 0.3\text{dB}$</p> <p>$\leq 100\text{MHz}$: $\pm 0.5\text{dB}$</p> <p>(relative to 100 kHz Sine wave, 1 Vpp, 50Ω)</p>
	AFG-4125AE	
	AFG-4225E	
	AFG-4235	
	AFG-4260	
	AFG-4280	
	AFG-4210H	
	AFG-4225H	<p>$\leq 10\text{MHz}$: $\pm 0.2\text{dB}$</p> <p>$\leq 60\text{MHz}$: $\pm 0.3\text{dB}$</p> <p>$\leq 100\text{MHz}$: $\pm 0.5\text{dB}$</p> <p>$\leq 160\text{MHz}$: $\pm 1\text{dB}$</p> <p>$\leq 250\text{MHz}$: $\pm 1.5\text{dB}$</p> <p>(relative to 1kHz Sine wave, 1 Vpp, 50Ω)</p>
Amplitude accuracy	AFG-4125E	<p>$\pm (2\% \text{ of setting} + 1 \text{ mVpp})(1\text{kHz sine, } 0\text{V offset, } >10 \text{ mVpp})$</p>
	AFG-4125AE	
	AFG-4225E	
	AFG-4235	
	AFG-4260	
	AFG-4280	
	AFG-4210H	
AFG-4225H		
Amplitude resolution	0.1mVpp or 4 digits (The amplitude $\geq 1\text{Vpp}$ is 1mVpp)	
Output impedance	50 Ω (typical)	
Output protection	Short circuit protection, output automatically disconnects when overloaded.	
DC offset range	$\pm (10 \text{ Vpk} - \text{Amplitude Vpp} / 2)$, (High resistance)	

DC offset accuracy	AFG-4125E	$\pm (3 \% \text{ of } \text{setting} + 5 \text{ mV} + \text{amplitude } V_{pp} * 0.5\%)$
	AFG-4125AE	
	AFG-4225E	
	AFG-4235	$\pm (1 \% \text{ of } \text{setting} + 5 \text{ mV} + \text{amplitude } V_{pp} * 0.5\%)$
	AFG-4260	
	AFG-4280	
	AFG-4210H	
AFG-4225H		
Offset resolution	0.1 mVpp or 4 digits (The amplitude > 1 Vpp is 1 mVpp)	

Waveform characteristics

Sine

Harmonic distortion (DC Offset set to 0V)	AFG-4125E	Typical (0dBm) DC to 25MHz: <-50dBc
	AFG-4125AE	
	AFG-4225E	
	AFG-4235	Typical (0dBm) DC to 1MHz: <-65dBc 1MHz to 10MHz: <-60dBc 10MHz to 60MHz: <-55dBc 60MHz to 100MHz: <-50dBc
	AFG-4260	
	AFG-4280	
	AFG-4210H	
	AFG-4225H	Typical (0dBm) DC to 1MHz: <-65dBc 1MHz to 10MHz: <-60dBc 10MHz to 120MHz: <-50dBc 120MHz to 200MHz: <-45dBc
Total harmonic distortion	AFG-4125E	<0.1%, 10 Hz to 20 kHz, 1 Vpp
	AFG-4125AE	
	AFG-4225E	
	AFG-4235	<0.05 %, 10 Hz to 20 kHz, 1 Vpp
	AFG-4260	
	AFG-4280	
	AFG-4210H	
AFG-4225H		
Non-harmonic distortion	AFG-4125E	Typical (0dBm) <25MHz: <-45dBc
	AFG-4125AE	
	AFG-4225E	
	AFG-4235	Typical (0dBm)

	AFG-4260	$\leq 10\text{MHz}$: $< -70\text{dBc}$
	AFG-4280	$> 10\text{MHz}$: $< -70\text{dBc} + 6\text{dB/octave}$
	AFG-4210H	
	AFG-4225H	
Phase noise	Typical (0dBm, 10kHz offset) 10MHz: $\leq -110\text{dBc/Hz}$	
Square		
	AFG-4125E	
	AFG-4125AE	$< 30\text{ns}$
	AFG-4225E	
	AFG-4235	
Rise/Fall time	AFG-4260	$< 8\text{ns}$
	AFG-4280	
	AFG-4210H	
	AFG-4225H	$< 5\text{ns}$
	AFG-4125E	
	AFG-4125AE	Typical (100 kHz, 1 Vpp) $< 5\%$, (1 Vpp, 50 Ω)
	AFG-4225E	
	AFG-4235	
Overshoot	AFG-4260	Typical (100 kHz, 1 Vpp) $< 3\%$, (1 Vpp, 50 Ω)
	AFG-4280	
	AFG-4210H	
	AFG-4225H	
Duty cycle	50.0% (Fixed)	
Triangle		
Linearity	$< 0.1\%$ of peak output (Typical 1 kHz, 1 Vpp, 50% symmetry)	
Symmetry	0.0% to 100.0%	

Pulse		
Duty	AFG-4125E	200 ns to 1000 ks
	AFG-4125AE	
	AFG-4225E	
	AFG-4235	66.667 ns to 1000 ks
	AFG-4260	40 ns to 1000 ks
	AFG-4280	
	AFG-4210H	
	AFG-4225H	
Pulse Width	AFG-4125E	$\geq 48\text{ns}$
	AFG-4125AE	
	AFG-4225E	
	AFG-4235	$\geq 18\text{ns}$
	AFG-4260	$\geq 12\text{ns}$
	AFG-4280	
	AFG-4210H	
	AFG-4225H	
Duty cycle	0.1% to 99.9% (limited by frequency setting)	
Rise/Fall time	AFG-4125E	$\geq 32\text{ns}$ (limited by pulse width setting)
	AFG-4125AE	
	AFG-4225E	
	AFG-4235	$\geq 8\text{ns}$ (limited by pulse width setting)
	AFG-4260	
	AFG-4280	
	AFG-4210H	
	AFG-4225H	$\geq 7\text{ns}$ (limited by pulse width setting)
Overshoot	AFG-4125E	Typical (100 kHz, 1 Vpp) < 5%
	AFG-4125AE	
	AFG-4225E	
	AFG-4235	Typical (100 kHz, 1 Vpp) < 3%
	AFG-4260	
	AFG-4280	
	AFG-4210H	
	AFG-4225H	
Noise		

Type	Gaussian white noise	
Bandwidth (-3dB)	AFG-4125E	25MHz BW
	AFG-4125AE	
	AFG-4225E	
	AFG-4235	35MHz BW
	AFG-4260	60MHz BW
	AFG-4280	80MHz BW
	AFG-4210H	100MHz BW
	AFG-4225H	120MHz BW
Harmonic		
Harmonic order	≤16	
Frequency Range	AFG-4125E	1μHz to 12.5MHz
	AFG-4125AE	
	AFG-4225E	
	AFG-4235	1μHz to 17.5MHz
	AFG-4260	1μHz to 30MHz
	AFG-4280	1μHz to 40MHz
	AFG-4210H	1μHz to 50MHz
	AFG-4225H	1μHz to 125MHz
Harmonic type	Odd, even, sequence, custom	
Harmonic amplitude	The amplitude of each harmonic can be set	
Harmonic phase	Each harmonic phase can be set	

Modulation Characteristics
AM

Carrier	Sine, Square, Ramp, ARB(except DC) (ARB length is 8192)
Modulated signal source	Internal or External
Internal modulation waveform	Sin, Square, Ramp, Noise, ARB
Internal amplitude modulation frequency	2 mHz to 1 MHz

Depth	0% to 120%
DSBAM	
Carrier	Sine, Square, Ramp
Modulated signal source	Internal or External
Internal modulation waveform	Sine, Square, Ramp
Internal amplitude modulation frequency	2 mHz to 1 MHz
Depth	0% to 100%
FM	
Carrier	Sine, Square, Ramp, ARB(except DC) (ARB length is 8192)
Modulated signal source	Internal or External
Internal modulation waveform	Sine, square, ramp, noise, ARB
Internal amplitude modulation frequency	2 mHz to 1 MHz
Frequency offset	$2 \text{ mHz} \leq \text{offset} \leq \min(\text{carrier frequency}, \text{carrier maximum frequency carrier frequency})$ by default, the smaller of the two
PM	
Carrier	Sine, square, ramp, ARB (except DC) (ARB length is 8192)
Modulated signal source	Internal or External
Internal modulation waveform	Sine, square, ramp, noise, ARB
Internal amplitude modulation frequency	2 mHz to 1 MHz
Phase deviation range	0° to 180°

PWM

Carrier	Pulse
Modulated signal source	Internal or External
Internal modulation waveform	Sine, square, ramp, noise, ARB (except DC) (ARB length is 8192)
Internal amplitude modulation frequency	2 mHz to 1 MHz
Offset	Offset 0 to min (min is the smaller value of pulse wave duty cycle and 100%-pulse wave duty cycle)

ASK

Carrier	Sine, square, ramp, ARB (ARB length is 8192)
Modulated signal source	Internal or External
Internal modulation waveform	50% duty cycle Square
ASK frequency	2 mHz to 1MHz

PSK

Carrier	Sine, square, ramp, ARB (ARB length is 8192)
Modulated signal source	Internal or External
Internal modulation waveform	50% duty cycle Square
PSK frequency	2 mHz to 1MHz

FSK

Carrier	Sine, square, ramp, ARB (ARB length is 8192)
Modulated signal source	Internal or External
Internal modulation waveform	50% duty cycle Square
FSK frequency	2 mHz to 1MHz

3FSK

Carrier	Sine, square, ramp, ARB (ARB length is 8192)
Modulated signal source	Internal

Internal modulation waveform	50% duty cycle Square
FSK frequency	2 mHz to 1MHz
4FSK	
Carrier	Sine, square, ramp, ARB (ARB length is 8192)
Modulated signal source	Internal
Internal modulation waveform	50% duty cycle Square
FSK frequency	2 mHz to 1MHz
BPSK	
Carrier	Sine, square, ramp, ARB (ARB length is 8192)
Modulated signal source	Internal
Internal modulation waveform	50% duty cycle Square
BPSK frequency	2 mHz to 1MHz
QPSK	
Carrier	Sine, square, ramp, ARB (ARB length is 8192)
Modulated signal source	Internal
Internal modulation waveform	50% duty cycle Square
QPSK frequency	2 mHz to 1MHz
OSK	
Carrier	Sine wave
Modulated signal source	Internal
Internal modulation waveform	50% duty cycle Square
Oscillation time	<u>8ns to 249.75s</u>
OSK frequency	2 mHz to 1MHz
SUM	
Carrier	Sine, square, ramp
Modulated signal source	Internal or External
Internal	Sine, square, ramp, noise, ARB

modulation waveform	
Internal amplitude modulation frequency	2 mHz to 1 MHz
Depth	0% to 100%

Sweep Characteristics

Carrier	Sine, square, ramp, ARB (except DC) (ARB length is 8192)
---------	--

Minimum starting frequency	1uHz
----------------------------	------

Maximum stop frequency	Sine wave	AFG-4125E	25 MHz
		AFG-4125AE	
		AFG-4225E	
		AFG-4235	35 MHz
		AFG-4260	60 MHz
		AFG-4280	80 MHz
		AFG-4210H	100 MHz
		AFG-4225H	250 MHz
	Square wave	AFG-4125E	5 MHz
		AFG-4125AE	
		AFG-4225E	
		AFG-4235	15 MHz
		AFG-4260	30 MHz
		AFG-4280	
		AFG-4210H	
	AFG-4225H	50 MHz	
	Triangle wave	AFG-4125E	1 MHz
		AFG-4125AE	
		AFG-4225E	
		AFG-4235	3 MHz
		AFG-4260	
		AFG-4280	
		AFG-4210H	
	AFG-4225H	5 MHz	
Arbitrary wave	AFG-4125E	15 MHz	
	AFG-4125AE		
	AFG-4225E		
	AFG-4235	15MHz (built-in waveform) or	
	AFG-4260		

		AFG-4280	25MHz (user-defined waveform)
		AFG-4210H	
		AFG-4225H	
Types	Linear, logarithmic, Step		
Sweep direction	Up / Down		
Sweep time	1 ms $\bar{\text{至}}$ 500 s \pm 0.1%		
Trigger source	Internal, external, manual		

Burst Characteristics

Waveform	Sine, square, ramp, pulse, Noise(Except N Cycle) ,ARB (Except DC) (ARB length is 8192)		
Types	Count (1 to 1000,000 cycles), <u>Infinite</u> , gated		
Trigger source	Internal, External, Manual		
Carrier frequency	2mHz to BW/ 2		
Trigger cycle	20ns - 500 s (Min = Cycles * Period)		
Gated source	External trigger		

Counter Specifications

Measurement function	Frequency, period, positive pulse width, negative pulse width, duty cycle		
Frequency Range	100 mHz - 200 MHz		
Frequency resolution	7 digits		
Coupling method	AC, DC		
Voltage range and sensitivity (non-modulated signal)			
DC offset range	\pm 1.5 V		
DC coupling	100 mHz ~ 100 MHz: 250 mVpp - 5 Vpp (AC+DC) 100 Hz ~ 200 MHz: 400 mVpp - 5 Vpp (AC+DC)		
AC coupling	1 Hz ~ 100 MHz: 250 mVpp - 5 Vpp 100 Hz ~ 200 MHz: 400 mVpp - 5 Vpp		
Pulse width and duty cycle measurement	1 Hz ~ 10 MHz(250 mVpp ~ 5 Vpp)		
Input resistance	1 M Ω		
Sensitivity	Can be set high, medium and low		

Trigger level range	± 2.5 V
---------------------	-------------

Power Amplifier Characteristics

Max Output Power	10W
Gain	X10
Bandwidth (at full power)	5 Hz to 100 kHz
Offset	<7%
Input Impedance	10 k Ω
Output Impedance	< 2 Ω
Max Input Voltage	2 V _{pp}
Max Output Voltage	20 V _{pp}
Max Output Power	5 V/us

Input/Output Characteristics

Channel coupling	Channel copy, amplitude syn, frequency syn, align phase
------------------	---

External modulation input

Input frequency range	DC - 100 kHz (Due to hardware limitations, it is best to set the external modulation frequency to be less than 20KHz)
Input level range	± 1 V full scale
Input impedance	10 k Ω (typical)

External trigger input

Level	TTL-compatible
Slope	Rising or falling (selectable)
Pulse Width	>100ns

External clock input (Counter input)

Impedance	1M Ω , AC coupling
Input level range	1V _{pp} to 3.3V _{pp}
Lock time	<1s
Lock range	10 MHz \pm 50Hz

Internal clock output	
Frequency	10 MHz \pm 50Hz
Impedance	50 Ω , DC coupling
Amplitude	1.2V _{pp} (50 Ω)
Sync Output	
Level	3.3V (LVTTTL)
Impedance	50 Ω , DC coupling
Maximum frequency	1MHz

General Specifications

Display

Feature	Description	
Type	8-inch color LCD display	
Resolution	800 Horizontal \times 480 Vertical pixels	
Color	65536 colors, 16 bits, TFT	
Touch screen capacitive	AFG-4235	Multi-touch
	AFG-4260	
	AFG-4280	
	AFG-4210H	
	AFG-4225H	
Communication Interface	AFG-4125E	USB Host, USB Device
	AFG-4125AE	
	AFG-4225E	
	AFG-4235	USB Host, USB Device, LAN
	AFG-4260	
	AFG-4280	
	AFG-4210H	
AFG-4225H		

Power

Feature	Description
Voltage	100 - 240 V (\pm 10%), 50 / 60 Hz
Power consumption	Less than 50VA
Fuse	250V, F2AL

Environment

Feature	Description
Temperature	Satisfy the specification: 18°C~28°C Working temperature: 0°C~40°C Storage temperature: -20°C~60°C Humidity: <70%
Installation category	CAT II
Relative humidity	Less than 35°C: ≤ 90% 35°C to 40°C: ≤ 60%
Height	Operating 3,000 meters Non-operation 12,000 meters
Pollution Degree	IEC 61010 degree 2, Indoor use
Safety designed	EN61010-1
Cooling method	Smart fan cooling

Mechanical Specification

Feature	Description
Dimension	340 mm (Length) × 177 mm (Height) × 90mm (Width)
Weight	Approx. 2.5 kg

Adjustment interval:

The recommended calibration interval is one year.

Build-in wave list

Feature	Description
Common	
DC	Direct current
AbsSine	Absolute sine
AbsSineHalf	Absolute half-sine
AmpALT	Gain oscillation curve
AttALT	Attenuation oscillation curve
GaussPulse	Gauss pulse
NegRamp	Negative ramp
NPulse	Negative pluse
PPulse	Positive pluse
SineTra	Sine-Tra wave
SineVer	Sine-Ver wave
StairDn	Stair downward
StairUP	Stair upward
StairUD	Stair downward
Trapezia	Trapezia
Medical	
Heart	Heart
Cardiac	Cardiac
LFPulse	Low frequency pulse electrotherapy waveform
Tens1	Neuroelectric stimulation therapy waveform 1
Tens2	Neuroelectric stimulation therapy waveform 2
Tens3	Neuroelectric stimulation therapy waveform 3
EOG	Electrooculogram
EEG	Electroencephalogram
Pulseilogram	Ordinary pulse curve
ResSpeed	Ordinary expiratory flow rate curve
Standard	
Ignition	Automobile internal combustion engine ignition waveform
TP2A	Automotive transients due to inductance in the wiring
SP	Automobile starting profile with oscillation
VR	Working voltage profile of the car when resetting
TP1	Automotive transients due to power cuts
TP2B	Car transients due to startup switching off
TP4	Car working profile during start-up
TP5A	Car transients due to the power cut of battery

TP5B	Car transients due to the power cut of battery
SCR	SCR Sintering temperature release map
Surge	Automobile internal combustion engine ignition waveform
Math	
Airy	Airy function
Besselj	Type I Bessel function
Bessely	Type II Bessel function
Cauchy	Cauchy distribution
X^3	Cubic function
Erf	Error function
Erfc	Remnant error function
ErfcInv	Anti-complement error function
ErfInv	Inverse error function
Dirichlet	Dirichlet function
ExpFall	Exponential decline function
ExpRise	Exponential rise function
Laguerre	Four Laguerre polynomials
Laplace	Laplace distribution
Legend	Five Legendre polynomials
Gauss	Gaussian distribution, also known as the normal distribution
HaverSine	Semi-positive function
Log	Base 10 logarithmic function
LogNormal	Lognormal distribution
Lorentz	Lorentz function
Maxwell	Maxwell distribution
Rayleigh	Rayleigh distribution
Versiera	Tongue line
Weibull	Weber distribution
Ln(x)	Natural logarithmic waveform
X^2	Square function
Round	Round wave
Chirp	Linear frequency modulation
Rhombus	Diamond wave
Trigonometric function	
CosH	Hyperbolic cosine
Cot	Cotangent function
CotHCon	Hyperbolic cotangent
CotHPro	Concave hyperbolic cotangent
CscCon	Raised hyperbolic cotangent
CscPro	Recessed cosecant

CscHCon	Cosecant
CscHPro	Raised cosecant
RecipCon	Hyperbolic cosecant
RecipPro	Depressed hyperbolic cosecant
SecCon	Raised hyperbolic cosecant
SecPro	Reciprocal of the depression
SecH	Raised countdown
Sinc	Depression secant
SinH	Raised secant
Sqrt	Hyperbolic secant
Tan	Sinc function
TanH	Hyperbolic sine
ACos	Square root function
ACosH	Tangent function
ACot	Hyperbolic tangent
ACotCon	Inverse cosine function
ACotPro	Inverse hyperbolic cosine function
ACotH	Anti-cotangent function
ACotHCon	Inverse cotangent function
ACotHPro	Raised inverse cotangent function
ACscCon	Inverse hyperbolic cotangent function
ACscPro	Inverse hyperbolic cotangent function
ACscHCon	Raised inverse hyperbolic cotangent function
ACscHPro	Anti-cosecting function
ASecCon	Concave inverse cosecting function
ASecPro	Raised anti-cosecting function
ASecH	Anti-hyperbolic cosecant
ASin	Inverse hyperbolic cotangent function
ASinH	Raised inverse hyperbolic cosecant function
ATan	Inverse cut function
ATanH	Inverse tangent function
Window function	
Bartlett	Bartlett window
BarthannWin	Modified Bartlett window
Blackman	Blackman window
BlackmanH	BlackmanH window
BohmanWin	BohmanWin window
Boxcar	Rectangular window
ChebWin	Chebyshev window
FlattopWin	Flat top window
Hamming	Hamming window
Hanning	Hanning window

Kaiser	Kaiser window
NuttackWub	The smallest four Blackman-Harris windows
ParzenWin	Parzen window
TaylorWin	Taylor window
Triang	Triangle window, also call Fejer window
TukeyWin	Tukey window
Engineering Window	
Butterworth	Butterworth filter
Combin	Combined function
CPulse	C-Pulse signal
CWPulse	CW pulse signal
RoundsHalf	Half-round wave
BandLimited	Band limited signal
BlaseiWave	Blasting vibration "time-vibration speed" curve
Chebyshev1	Type I Chebyshev filter
Chebyshev2	Type II Chebyshev filter
DampedOsc	Damped oscillation "time-displacement" curve
DualTone	Dual audio signal
Gamma	Gamma signal
GateVibar	Gate self-vibration signal
LFMPulse	Chirp signal
MCNoise	Mechanical construction noise
Discharge	NiMH battery discharge curve
Quake	Seismic wave
Radar	Radar signal
Ripple	Ripple
RoundsPM	Rounds PM wave
StepResp	Step response signal
SwingOsc	Swing oscillation kinetic energy-time curve
TV	TV signal
Voice	Voice signal
Segment Modulation	
AM	Sinusoidal segmented AM wave
FM	Sinusoidal segmented FM wave
PM	Sinusoidal segmented PM wave
PWM	Pulse width segmented PWM wave

Certificate Of Compliance

We

GOOD WILL INSTRUMENT CO., LTD.

declare that the CE marking mentioned product satisfies all the technical relations application to the product within the scope of council:

Directive: EMC; LVD; WEEE; RoHS

The product is in conformity with the following standards or other normative documents:

© EMC	
EN 61326-1	Electrical equipment for measurement, control and laboratory use -- EMC requirements
Conducted & Radiated Emission EN 55011 / EN 55032	Electrical Fast Transients EN 61000-4-4
Current Harmonics EN 61000-3-2 / EN 61000-3-12	Surge Immunity EN 61000-4-5
Voltage Fluctuations EN 61000-3-3 / EN 61000-3-11	Conducted Susceptibility EN 61000-4-6
Electrostatic Discharge EN 61000-4-2	Power Frequency Magnetic Field EN 61000-4-8
Radiated Immunity EN 61000-4-3	Voltage Dip/ Interruption EN 61000-4-11 / EN 61000-4-34
© Safety	
EN 61010-1 :	Safety requirements for electrical equipment for measurement, control, and laboratory use - Part 1: General requirements

GOODWILL INSTRUMENT CO., LTD.

No. 7-1, Jhongsing Road, Tucheng District, New Taipei City 236, Taiwan

Tel: [+886-2-2268-0389](tel:+886-2-2268-0389)

Fax: [+886-2-2268-0639](tel:+886-2-2268-0639)

Web: <http://www.gwinstek.com>

Email:

marketing@goodwill.com.tw

GOODWILL INSTRUMENT (SUZHOU) CO., LTD.

No. 521, Zhujiang Road, Snd, Suzhou Jiangsu 215011, China

Tel: [+86-512-6661-7177](tel:+86-512-6661-7177)

Fax: [+86-512-6661-7277](tel:+86-512-6661-7277)

Web: <http://www.instek.com.cn>

Email: marketing@instek.com.cn

GOODWILL INSTRUMENT EURO B.V.

De Run 5427A, 5504DG Veldhoven, The Netherlands

Tel: [+31-\(0\)40-2557790](tel:+31-(0)40-2557790)

Fax: [+31-\(0\)40-2541194](tel:+31-(0)40-2541194)

Email: sales@gw-instek.eu

APPENDIX

Appendix A: Attachments

- Declaration of Traceable Calibration
 - Test Lead
 - AFG-4125E/4125AE: BNC to Alligator Clips Cable *1
 - AFG-4225E/4235: BNC to Alligator Clips Cable *2
 - AFG-4260/4280/4210H/4225H: BNC Cable *2
 - USB communication cable *1
 - AC Power Cord *1
-

Appendix B: Care and Cleaning Maintenance

General maintenance

Do not store or place the instrument in a place where the LCD display will be exposed to direct sunlight for a long time.



Caution

Keep sprays, liquids, and solvents away from the instrument to avoid damage.

Clean

Check the instrument frequently according to usage. Follow these steps to clean the outside of the instrument:

Steps

1. Please wipe the dust on the outside of the instrument with a soft cloth. When cleaning

the LCD screen, be careful not to scratch the transparent LCD protective screen.

2. Wipe the instrument with a damp but non-drying soft cloth, and be sure to disconnect the power supply. Can be scrubbed with mild detergent or clean water. Do not use any abrasive chemical cleaning agents to avoid damaging the instrument.
-



Warning

Before re-powering the instrument, please make sure it is completely dry to avoid electrical short circuit or even personal injury caused by moisture.

Appendix C: Troubleshooting

Steps

1. **If the instrument still has a black screen without any display after pressing the power switch, please follow the steps below:**

- Check whether the power connector is connected properly.
- Check whether the voltage selector is in the correct position.
- Check whether the fuse at the power interface meets the specified type and rating, and whether it is blown out (you can pry it off with a flat-blade screwdriver).
- After completing the above checks, restart the instrument.
- If you still cannot use this product normally, please contact our company and let us serve you.

2. **The measured value of the output signal amplitude is inconsistent with the displayed value:**

Check whether the actual load value of the signal is consistent with the load value set by the system. For details, see "Set the load value". If you encounter other problems, try resetting settings (see "Clock") or restarting. If you still cannot use this product normally, please contact our company and let us serve you.

Certificate Of Compliance

We

GOOD WILL INSTRUMENT CO., LTD.

declare that the CE marking mentioned product satisfies all the technical relations application to the product within the scope of council:

Directive: EMC; LVD; WEEE; RoHS

The product is in conformity with the following standards or other normative documents:

© EMC	
EN 61326-1	Electrical equipment for measurement, control and laboratory use -- EMC requirements
Conducted & Radiated Emission EN 55011 / EN 55032	Electrical Fast Transients EN 61000-4-4
Current Harmonics EN 61000-3-2 / EN 61000-3-12	Surge Immunity EN 61000-4-5
Voltage Fluctuations EN 61000-3-3 / EN 61000-3-11	Conducted Susceptibility EN 61000-4-6
Electrostatic Discharge EN 61000-4-2	Power Frequency Magnetic Field EN 61000-4-8
Radiated Immunity EN 61000-4-3	Voltage Dip/ Interruption EN 61000-4-11 / EN 61000-4-34
© Safety	
EN 61010-1 :	Safety requirements for electrical equipment for measurement, control, and laboratory use - Part 1: General requirements

GOODWILL INSTRUMENT CO., LTD.

No. 7-1, Jhongsing Road, Tucheng District, New Taipei City 236, Taiwan

Tel: [+886-2-2268-0389](tel:+886-2-2268-0389)

Fax: [+886-2-2268-0639](tel:+886-2-2268-0639)

Web: <http://www.gwinstek.com>

Email:

marketing@goodwill.com.tw

GOODWILL INSTRUMENT (SUZHOU) CO., LTD.

No. 521, Zhujiang Road, Snd, Suzhou Jiangsu 215011, China

Tel: [+86-512-6661-7177](tel:+86-512-6661-7177)

Fax: [+86-512-6661-7277](tel:+86-512-6661-7277)

Web: <http://www.instek.com.cn>

Email: marketing@instek.com.cn

GOODWILL INSTRUMENT EURO B.V.

De Run 5427A, 5504DG Veldhoven, The Netherlands

Tel: [+31-\(0\)40-2557790](tel:+31-(0)40-2557790)

Fax: [+31-\(0\)40-2541194](tel:+31-(0)40-2541194)

Email: sales@gw-instek.eu