



RIGOL

DSG5000 Series

Microwave Signal Generator

User Guide

Nov. 2024

Guaranty and Declaration

Copyright

© 2024 RIGOL TECHNOLOGIES CO., LTD. All Rights Reserved.

Trademark Information

RIGOL® is the trademark of RIGOL TECHNOLOGIES CO., LTD.

Notices

- RIGOL products are covered by P.R.C. and foreign patents, issued and pending.
- RIGOL reserves the right to modify or change parts of or all the specifications and pricing policies at the company's sole decision.
- Information in this publication replaces all previously released materials.
- Information in this publication is subject to change without notice.
- RIGOL shall not be liable for either incidental or consequential losses in connection with the furnishing, use, or performance of this manual, as well as any information contained.
- Any part of this document is forbidden to be copied, photocopied, or rearranged without prior written approval of RIGOL.

Product Certification

RIGOL guarantees that this product conforms to the national and industrial standards in China as well as the ISO9001:2015 standard and the ISO14001:2015 standard. Other international standard conformance certifications are in progress.

Contact Us

If you have any problem or requirement when using our products or this manual, please contact RIGOL.

E-mail: service@rigol.com

Website: <http://www.rigol.com>

Section	Description	Page
	List of Figures.....	IV
1	Safety Requirement	1
1.1	General Safety Summary	1
1.2	Safety Notices and Symbols	2
1.3	Measurement Category	3
1.4	Care and Cleaning	4
1.5	Environmental Considerations	4
2	DSG5000 Series Overview	5
3	Document Overview	6
4	Quick Start	8
4.1	General Inspection	8
4.2	Appearance and Dimensions	8
4.3	Front Panel Overview	9
4.4	Rear Panel Overview	12
4.5	To Use the Instrument for the First Time	13
4.5.1	To Connect to AC Power	13
4.5.2	Instrument Control	14
4.5.3	Turn-on Checkout	15
4.5.4	To Set the System Language	15
4.6	OCXO Reference Clock (Option)	15
4.7	Fuse Replacement	16
4.8	User Interface	17
4.9	To Use the Built-in Help File	20
5	Keypad Setting	21
5.1	Numeric Keypad for Setting Parameter Values	21
5.2	Alphanumeric Keypad for Filename Input	23
6	Frequency	29
6.1	Frequency Setting	29
6.2	Freq Offset	29
6.3	Phase Offset	30
6.4	Phase Reset	30
7	Amplitude	31
7.1	Amplitude Setting	31

7.2	Amplitude Limit	31
7.3	Amplitude Offset	31
7.4	Flatness Calibration	32
7.5	Amplitude Unit	33
8	Sweep	34
8.1	Sweep Function	34
8.2	Sweep Type	34
8.2.1	Step Sweep	34
8.2.2	List Sweep	37
8.3	Sweep Mode	38
8.4	Trigger	39
9	Modulation	42
9.1	Amplitude Modulation (AM)	42
9.1.1	To Enable the Amplitude Modulation	42
9.1.2	To Select the Modulation Source	42
9.1.3	To Set the Modulation Depth	42
9.1.4	To Set the Modulation Frequency	43
9.1.5	To Set Other AM-related Parameters	43
9.2	Frequency Modulation (FM)	45
9.2.1	To Enable the Frequency Modulation	45
9.2.2	To Select the Modulation Source	45
9.2.3	To Set the Frequency Deviation	46
9.2.4	To Set the Modulation Rate	46
9.2.5	To Set Other FM-related Parameters	46
9.3	Phase Modulation (PM)	47
9.3.1	To Enable the Phase Modulation	47
9.3.2	To Select Modulation Source	47
9.3.3	To Set the Phase Deviation	48
9.3.4	To Set the Modulation Rate	48
9.3.5	To Set Other PM-related Parameters	48
9.4	Pulse Modulation	49
9.4.1	To Enable the Pulse Modulation	49
9.4.2	To Select Modulation Source	49
9.4.3	To Set the Pulse Type	50
9.4.4	To Set Other Pulse-related Parameters	50
9.4.5	Trigger	52
10	System Utility Setting	55

10.1	Interface Setting	55
10.1.1	LAN	55
10.2	Preset	57
10.3	AUX	57
10.3.1	4.8 GHz Signal Input/Output	57
10.4	Upgrade	58
10.4.1	Local Upgrade	58
10.4.2	Online Upgrade	60
10.5	System	60
10.6	Storage	61
10.6.1	Storage	61
10.6.2	Disk Management	62
10.7	Help Menu	63
10.8	Setting	63
10.8.1	Basic Settings	63
10.8.2	Self Check	64
11	Remote Control	66
11.1	Remote Control via USB	67
11.2	Remote Control via LAN	67
12	Application Examples	69
12.1	To Output the RF Signal	69
12.2	To Output the RF Sweep Signal	70
12.3	To Output the RF Modulated Signal	71
13	Troubleshooting	73
14	Appendix	76
14.1	Appendix A: Accessories and Option List	76
14.2	Appendix B: Warranty	77

List of Figures

Figure 4.1 Front View (Unit: mm)	8
Figure 4.2 Vertical View (Unit: mm)	9
Figure 4.3 Front Panel	9
Figure 4.4 Rear Panel	12
Figure 4.5 To Connect to AC Power	14
Figure 4.6 Disassemble the OCXO Plate	16
Figure 4.7 Fasten the Plate to the Rear Panel of the Signal Generator	16
Figure 4.8 Fuse Replacement	17
Figure 4.9 User Interface	17
Figure 5.1 Numeric Keypad	21
Figure 5.2 Chinese Character Input	24
Figure 5.3 English Letter Input	26
Figure 5.4 Number Input Keypad	28
Figure 8.1 Diagram of the Sweep Shape in "Fwd" Sweep Direction	36
Figure 9.1 Diagram of Equal Level Output	44
Figure 9.2 Trigger Delay	53
Figure 10.1 System Utility Setting	55
Figure 10.2 File Resource Management System	59

1 Safety Requirement

1.1 General Safety Summary

Please review the following safety precautions carefully before putting the instrument into operation so as to avoid any personal injury or damage to the instrument and any product connected to it. To prevent potential hazards, please follow the instructions specified in this manual to use the instrument properly.

- **Use Proper Power Cord.**

Only the exclusive power cord designed for the instrument and authorized for use within the local country could be used.

- **Ground the Instrument.**

The instrument is grounded through the Protective Earth lead of the power cord. To avoid electric shock, it is essential to connect the earth terminal of the power cord to the Protective Earth terminal before connecting any inputs or outputs.

- **Observe All Terminal Ratings.**

To avoid fire or shock hazard, observe all ratings and markers on the instrument and check your manual for more information about ratings before connecting the instrument.

- **Use Proper Overvoltage Protection.**

Ensure that no overvoltage (such as that caused by a bolt of lightning) can reach the product. Otherwise, the operator might be exposed to the danger of an electric shock.

- **Do Not Operate Without Covers.**

Do not operate the instrument with covers or panels removed.

- **Do Not Insert Objects Into the Air Outlet.**

Do not insert anything into the holes of the fan to avoid damaging the instrument.

- **Use Proper Fuse.**

Please use the specified fuses.

- **Avoid Circuit or Wire Exposure.**

Do not touch exposed junctions and components when the unit is powered on.

- **Do Not Operate With Suspected Failures.**

If you suspect damage occurs to the instrument, have it inspected by RIGOL authorized personnel before further operations. Any maintenance, adjustment or

replacement especially to circuits or accessories must be performed by RIGOL authorized personnel.

- **Provide Adequate Ventilation.**

Inadequate ventilation may cause an increase of temperature in the instrument, which would cause damage to the instrument. So please keep the instrument well ventilated and inspect the air outlet and the fan regularly.

- **Do Not Operate in Wet Conditions.**

To avoid short circuit inside the instrument or electric shock, never operate the instrument in a humid environment.

- **Do Not Operate in an Explosive Atmosphere.**

To avoid personal injuries or damage to the instrument, never operate the instrument in an explosive atmosphere.

- **Keep Instrument Surfaces Clean and Dry.**

To avoid dust or moisture from affecting the performance of the instrument, keep the surfaces of the instrument clean and dry.

- **Prevent Electrostatic Impact.**

Operate the instrument in an electrostatic discharge protective environment to avoid damage induced by static discharges. Always ground both the internal and external conductors of cables to release static before making connections.

- **Handle with Caution.**

Please handle with care during transportation to avoid damage to keys, knobs, interfaces, and other parts on the panels.

**WARNING**

Equipment meeting Class A requirements may not offer adequate protection to broadcast services within residential environment.

1.2 Safety Notices and Symbols

Safety Notices in this Manual:

**WARNING**

Indicates a potentially hazardous situation or practice which, if not avoided, will result in serious injury or death.

**CAUTION**

Indicates a potentially hazardous situation or practice which, if not avoided, could result in damage to the product or loss of important data.

Safety Notices on the Product:

- **DANGER**
It calls attention to an operation, if not correctly performed, could result in injury or hazard immediately.
- **WARNING**
It calls attention to an operation, if not correctly performed, could result in potential injury or hazard.
- **CAUTION**
It calls attention to an operation, if not correctly performed, could result in damage to the product or other devices connected to the product.

Safety Symbols on the Product:

**Hazardous
Voltage**



Safety Warning



**Protective Earth
Terminal**

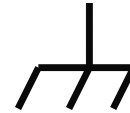

Chassis Ground



Test Ground

1.3 Measurement Category

Measurement Category

This instrument can make measurements in Measurement Category I.

**WARNING**

This instrument can only be used for measurements within its specified measurement categories.

Measurement Category Definitions

- **Measurement category I** is for measurements performed on circuits not directly connected to MAINS. Examples are measurements on circuits not derived from MAINS, and specially protected (internal) MAINS derived circuits. In the latter case, transient stresses are variable. Thus, you must know the transient withstand capability of the equipment.
- **Measurement category II** is for measurements performed on circuits directly connected to low voltage installation. Examples are measurements on household appliances, portable tools and similar equipment.
- **Measurement category III** is for measurements performed in the building installation. Examples are measurements on distribution boards, circuit-breakers, wiring (including cables, bus-bars, junction boxes, switches and socket-outlets) in the fixed installation, and equipment for industrial use and some other

equipment. For example, stationary motors with permanent connection to a fixed installation.

- **Measurement category IV** is for measurements performed at the source of a low-voltage installation. Examples are electricity meters and measurements on primary overcurrent protection devices and ripple control units.

1.4 Care and Cleaning

Care

Do not store or leave the instrument where it may be exposed to direct sunlight for long periods of time.

Cleaning

Clean the instrument regularly according to its operating conditions.

1. Disconnect the instrument from all power sources.
2. Clean the external surfaces of the instrument with a soft cloth dampened with mild detergent or water. Avoid having any water or other objects into the chassis via the heat dissipation hole. When cleaning the LCD, take care to avoid scarifying it.

CAUTION

To avoid damage to the instrument, do not expose it to caustic liquids.



WARNING

To avoid short-circuit resulting from moisture or personal injuries, ensure that the instrument is completely dry before connecting it to the power supply.



1.5 Environmental Considerations

The following symbol indicates that this product complies with the WEEE Directive 2012/19/EU.



The equipment may contain substances that could be harmful to the environment or human health. To avoid the release of such substances into the environment and avoid harm to human health, we recommend you to recycle this product appropriately to ensure that most materials are reused or recycled properly. Please contact your local authorities for disposal or recycling information.

You can click on the following link <https://int.rigol.com/services/services/declaration> to download the latest version of the RoHS&WEEE certification file.

2 DSG5000 Series Overview

DSG5000 series microwave signal generator is a multi-channel phase-coded microwave signal generator with the frequency up to 20 GHz, the output level range from -30 dBm to +25 dBm. The DSG5000 series includes models with 2, 4, 6, or 8 channels. With its high channel-to-channel phase stability, it can meet customers' demand for the application of the multi-channel coherent signals. The DSG5000 series has low phase noise and excellent spurious specifications. Besides the high stability clock (OCXO) option, it is equipped with AM, FM, PM, and Pulse modulation functions, which can be widely used in R&D, production, maintenance, education and training scenarios.

The DSG5000 series is equipped with the Android-based operating system. There are no physical keys except the power key button. The instrument can be controlled by the touch screen, the externally connected mouse, Web Control, and SCPI commands. The user-friendly operation mode has greatly improved the user experience. Besides the touch screen, the DSG5000 series also allows you to connect an external display via the HDMI interface.

Main Features

- Frequency range: 9 kHz to 20 GHz
- Frequency resolution: 0.01 Hz
- Output level setting range: -30 dBm to +25 dBm
- Amplitude resolution: 0.01 dB
- Phase noise: -133 dBc/Hz@10 kHz, carrier waveform 1 GHz (typ.)
- Amplitude error: <0.7 dB (typ.)
- Switchover time: <3 ms (typ.)
- Channel-to-channel phase stability: <1°@10 GHz
- Channel-to-channel isolation: > 80 dB (typ.)
- Harmonics spurious: <-50 dBc@10 GHz
- Modulation type: AM, FM, PM, and Pulse
- Communication interface: USB and LAN
- Number of Channels: 2, 4, 6, 8
- Structure dimensions: 2U height, full-rack width

Note: For more detailed specifications of the parameters, refer to Data Sheet. The technical specifications in Data Sheet shall prevail.

3 Document Overview

This manual provides a guidance on how to use the DSG5000 series microwave signal generator.



TIP

For the latest version of this manual, download it from the official website of **RIGOL** (<http://www.rigol.com>).

Publication Number

UGG04102-1110

Software Version

Software upgrade might change or add product features. Please acquire the latest version of the manual from **RIGOL** website or contact **RIGOL** to upgrade the software.

Format Conventions in this Manual

1. Key

The front panel key is denoted by the menu key icon. For example,  indicates the Power key.

2. Menu

The menu item is denoted by the format of "Menu Name (Bold) + Character Shading" in the manual. For example, **Freq** indicates clicking or tapping the "Freq" menu to enter the "Freq" setting configuration menu.

3. Operation Procedures

">" denotes the next step of operation. For example, **Interface** > **LAN** indicates that first clicking/tapping **Interface** and then clicking/tapping **LAN**.

4. Connector

The connectors on the front or rear panel are usually denoted by the format of "Connector Name (Bold) + Square Brackets (Bold)". For example, **[RF 50Ω]**.

Content Conventions in this Manual

DSG5000 series includes the following models. Unless otherwise specified, this manual takes DSG5208 as an example to illustrate how to use the series.

Model	Frequency Range	No. of Channels
DSG5202	9 kHz to 20 GHz	2
DSG5204	9 kHz to 20 GHz	4

Model	Frequency Range	No. of Channels
DSG5206	9 kHz to 20 GHz	6
DSG5208	9 kHz to 20 GHz	8
DSG5122	9 kHz to 12 GHz	2
DSG5124	9 kHz to 12 GHz	4
DSG5126	9 kHz to 12 GHz	6
DSG5128	9 kHz to 12 GHz	8

Manuals of this Product

The manuals of this product mainly include the quick guide, user guide, programming guide, data sheet, and etc. For the latest version of this manual, download it from the official website of RIGOL (<http://www.rigol.com>).

4 Quick Start

4.1 General Inspection

1. Inspect the packaging

If the packaging has been damaged, do not dispose the damaged packaging or cushioning materials until the shipment has been checked for completeness and has passed both electrical and mechanical tests.

The consigner or carrier shall be liable for the damage to the instrument resulting from shipment. RIGOL would not be responsible for free maintenance/rework or replacement of the instrument.

2. Inspect the instrument

In case of any mechanical damage, missing parts, or failure in passing the electrical and mechanical tests, contact your RIGOL sales representative.

3. Check the accessories

Please check the accessories according to the packing lists. If the accessories are damaged or incomplete, please contact your RIGOL sales representative.

Recommended Calibration Interval

RIGOL suggests that the instrument should be calibrated every 18 months.

4.2 Appearance and Dimensions

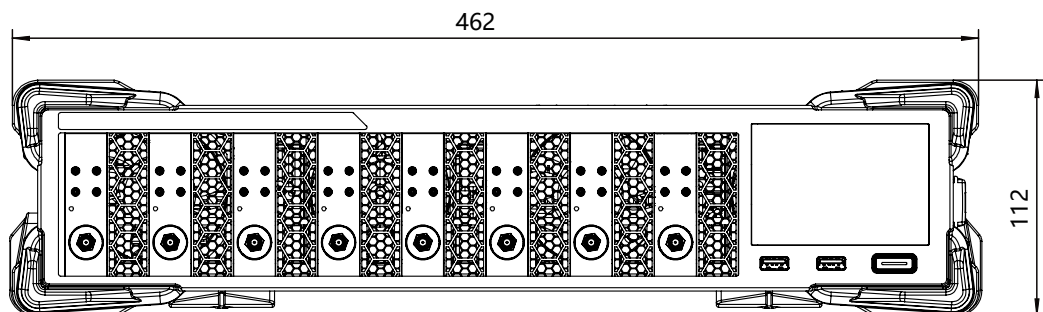

Figure 4.1 Front View (Unit: mm)

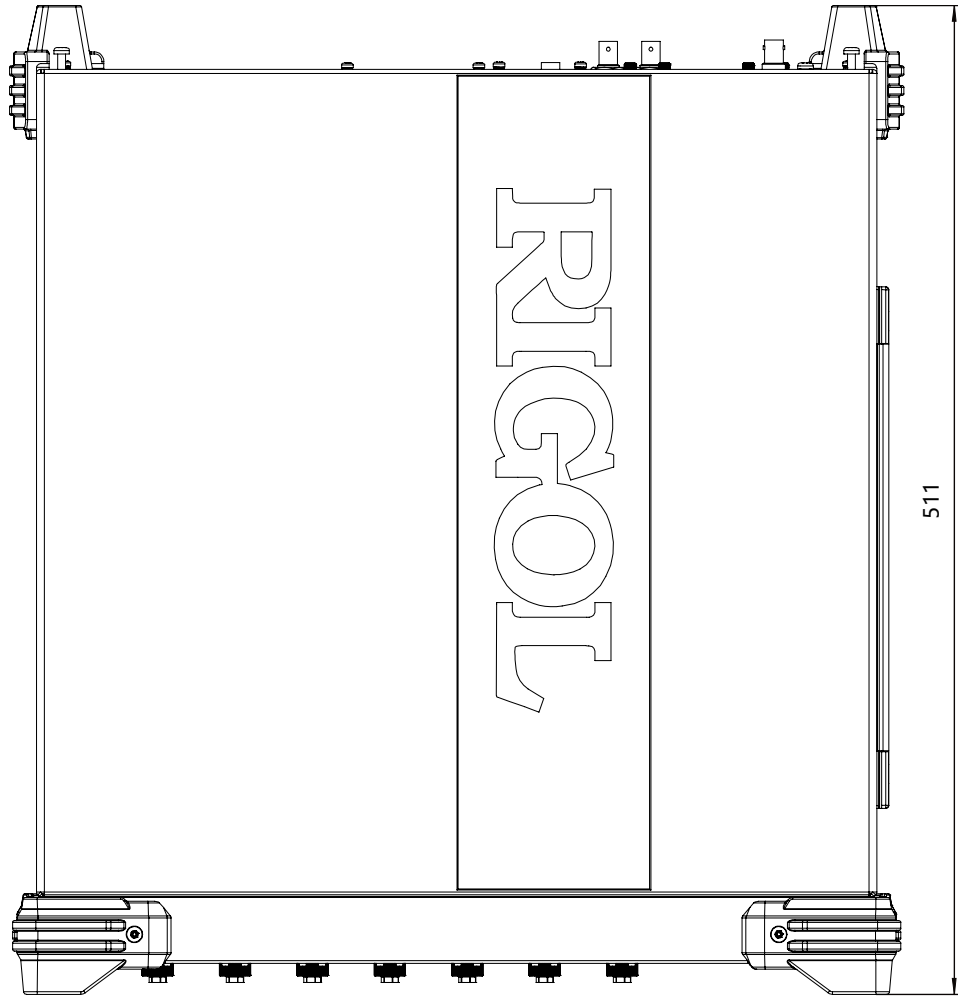

Figure 4.2 Vertical View (Unit: mm)

4.3 Front Panel Overview

The rear panel of DSG5000 series microwave signal generator is as shown in *Figure 4.3*.

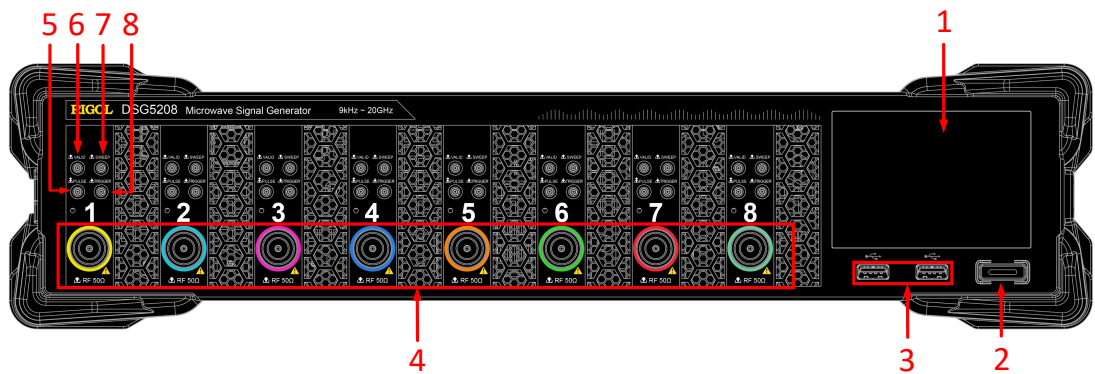



Figure 4.3 Front Panel

1. Touch Screen

Click or tap the menu on the touch screen, then it displays the menu label and parameter settings of the current function, system state, prompt messages, and other information.

2. Power Key

Turns on or off the instrument. When this key is turned off, the signal generator is in standby state, indicated by a pulsing LED. To fully disconnect the instrument from power, turn off the rear panel power switch and pull out the power cord.

Click or tap  > **Setting** > **Power Status** to select "Default" or "Open". When "Default" is selected, once the instrument is connected to power source, you need to press the power key button after turning on the rear-panel power switch. When "Open" is selected, once the instrument is connected to power source, the instrument starts automatically after the rear-panel power switch is turned on.

3. USB HOST

This interface is used to connect the USB storage device to upgrade the system, store system states and sweep lists.

4. RF Output Connector

When RF output is enabled, this connector is used to output RF signal and RF sweep signal of the specified channel.

When RF output is enabled and the modulation output is enabled, this connector is used to output the RF modulated signal.

CAUTION

To avoid damage to the instrument, the reverse DC voltage on the RF output connector cannot exceed 0 V, the reverse power must be less than 0.5 W.

5. PULSE Signal Input/Output Connector

The function of this connector is determined by the current working mode of the pulse modulation.

- When the modulation source of the pulse modulation is "Ext", the connector is used to input the external pulse signal.
- When the modulation source of the pulse modulation is "Int" and the pulse switch is ON, the connector is used to output the pulse signal generated by the internal generator. The output signal is related to the "Mode" of the modulation. The mode can be set to "Single" or "Train".

6. VALID Signal Output Connector

When the RF output frequency or amplitude is modified, the internal circuit responded it and processed it, then the instrument outputs the RF signal with the specified frequency and amplitude via the front-panel **[RF 50Ω]** output connector. During this process, the **[VALID]** connector outputs a pulse sync signal, indicating that the RF output signal is valid.

- **High Level**(+3.3 V): indicates that the RF signal is in configuration;
- **Low Level**(0 V): indicates that the RF signal is stable (namely, the signal is valid).

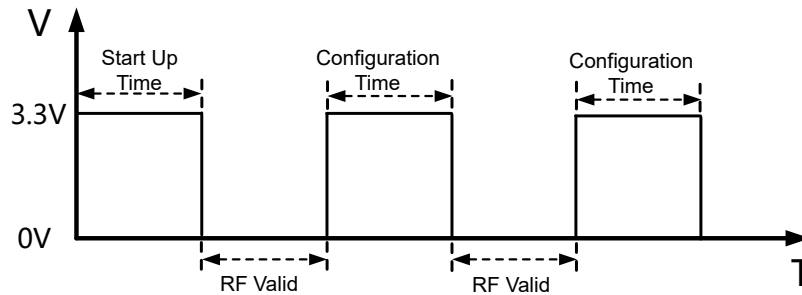

7. SWEEP Output Connector

When the RF sweep function is enabled, the **[SWEEP]** connector outputs a signal (0 V to +10 V) while the front-panel **[RF 50Ω]** output connector outputs the sweep signal according to the current setting. Each sweep corresponds to an output cycle.

- When the sweep type is Step, this output signal is related to the choice of sweep shape which can be set to "Triangle" or "Ramp".
- When the sweep type is List, the default of this output signal is Ramp.

8. External Trigger Input Connector

This connector is used to input the external trigger signal.

- When the trigger type of the sweep is "Ext", this connector is used to input external trigger signal. You can click or tap **Trig Slope** to select "Pos" or "Neg" as the polarity of the trigger signal.
- When the modulation source of the pulse modulation is "Int" and the trigger mode is "Ext", the connector is used to input the external trigger signal.
- When the modulation source of the pulse modulation is "Ext" and the trigger mode is "Gate", the connector is used to input external gate signal.

4.4 Rear Panel Overview

The rear panel of DSG5000 series microwave signal generator is as shown in [Figure 4.4](#).

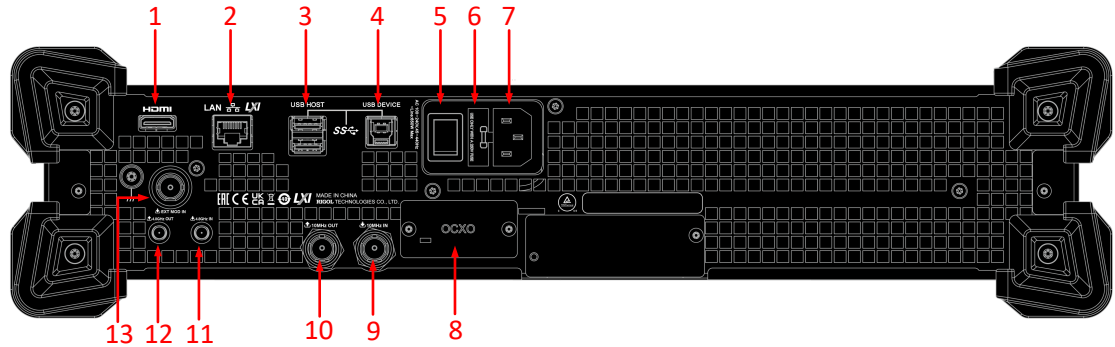

Figure 4.4 Rear Panel

1. HDMI

You can connect the instrument to an external display (e.g. monitor or projector) via this interface to better observe the waveform display clearly.

2. LAN

The instrument is in compliance with the standards specified in LXI Device Specification 2011. It supports to control the instrument through WebServer, Socket, and other modes of remote control. This interface is used to connect the instrument to the PC or network for remote control over the instrument.

3. USB HOST

This interface is used to connect the USB storage device to update the system, store system states and sweep lists.

4. USB DEVICE

This instrument complies with the USBTMC protocol. This interface is used to connect the instrument to the PC for remote control over the instrument.

5. Power Switch

Turns on or off the instrument.

6. Fuse

The fuse rating supported by the instrument is AC 250 V, T3.15A. For fuse replacement, refer to [Fuse Replacement](#).

7. Power Cord Connector

Used to connect the power cord. The AC power specification of the instrument is as follows: 100 Vac to 240 Vac, 45 Hz to 440 Hz. The power consumption of the instrument cannot exceed 650 W (with all the options working). When the instrument is connected to the AC power source via the power cord, the instrument automatically adjusts itself to within the proper voltage range, and you do not need to select the voltage range manually.

8. OCXO (Option OCXO-D08)

OCXO (Oven Controlled Crystal Oscillator) can provide a highly stable frequency reference over temperature variations.



TIP

A 40-minute warm-up is required for OCXO to reach its nominal frequency.

9. 10 MHz IN

Reference signal input connector. It is used to input the external 10 MHz reference clock signal which is used to synchronize the generator with other instruments.

10. 10 MHz OUT

Reference signal output connector. It is used to output the internal 10 MHz reference clock signal which is used to synchronize the generator with other instruments.

11. 4.8 GHz IN

4.8 GHz input connector. It is used to input the external 4.8 GHz reference clock signal.

12. 4.8 GHz OUT

4.8 GHz output connector. It is used to output the internal 4.8 GHz reference clock signal.

13. EXT MOD IN

External modulation input connector. When the modulation source of AM, FM, and PM is "Ext", this connector is used to input the external modulation signal.

4.5 To Use the Instrument for the First Time

4.5.1 To Connect to AC Power

Please use the power cord provided in the accessories to connect the instrument to the AC power source, as shown in [Figure 4.5](#). The AC power supply specification of this device is 100 Vac-240 Vac, 45 Hz-440 Hz. The power consumption of the instrument cannot exceed 650W (with all the options working). When the instrument

is connected to the AC power source via the power cord, the instrument automatically adjusts itself to within the proper voltage range, and you do not need to select the voltage range manually.

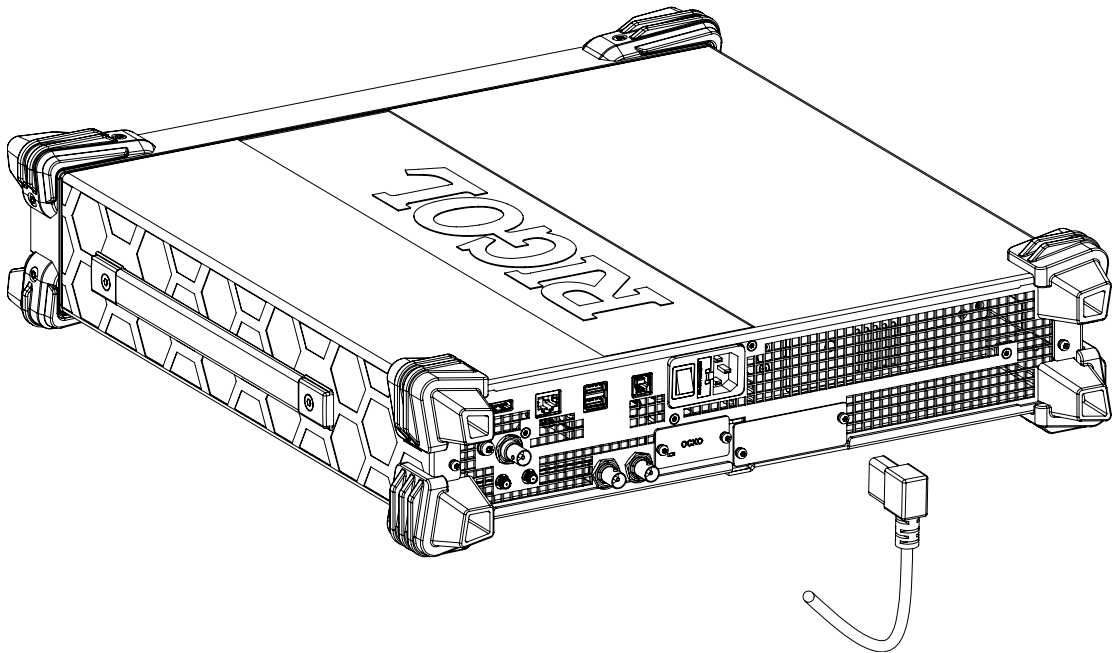

Figure 4.5 To Connect to AC Power



CAUTION

To avoid electric shock, ensure that the instrument is correctly grounded.

4.5.2 Instrument Control

DSG5000 series microwave signal generator has no physical keys to operate except the power key. You can operate on the instrument with the following methods: tap the touch screen to operate; use the externally connected display; Web Control.

- **Touch screen**

The instrument is equipped with a touch screen. You can operate the instrument with the touch screen.

- **Externally connected display**

You can connect the instrument to an external display (e.g. LCD, TV, projector, etc.) via the rear-panel HDMI interface to view the user interface and make parameter settings. To operate on the instrument, connect a USB mouse to the externally connected display via the USB Host interface.

- **Web Control**

Connect the oscilloscope to the network, then input the IP address of the oscilloscope into the address bar of the browser of your computer. The RIGOL web control interface is displayed. Click Web Control to enter the web control page. Then you can view the display of the real-time interface of oscilloscope. Through the Web Control, you can migrate the device control and waveform analysis to the control terminals (e.g. PC, Mobile, iPad, and other smart terminals) to realize remote control of instruments. For methods on how to realize Web Control for the instrument, refer to "*Remote Control*".



NOTE

This manual describes how to operate on the touch screen to demonstrate the main functions of the instrument. For some functions that are not accessible through the operation of the touch screen, see detailed descriptions for the relevant functions.

4.5.3 Turn-on Checkout

After connecting the instrument to the power source properly, press the rear-panel power switch key and the power key on the front panel to start the signal generator. During the start-up, the instrument will undergo the initialization and self-check process. Then, it will enter a default interface.

4.5.4 To Set the System Language

The instrument supports multiple system languages. You can click or tap  > **Setting** > **Language** to switch the system language.

4.6 OCXO Reference Clock (Option)

OCXO (Oven Controlled Crystal Oscillator), when working with RIGOL's RF signal generator, can provide a highly stable frequency reference over temperature variations. Its output frequency is 10 MHz.

OCXO, as a plug-and-play module, can be installed independently. Install the OCXO module to the signal generator according to the following procedures.

1. Use the T10 Hex Torx screwdriver to disassemble the OCXO plate from the rear panel of the signal generator.

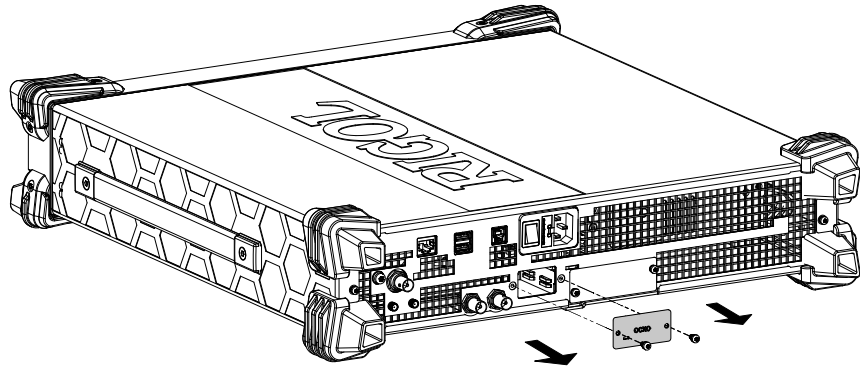

Figure 4.6 Disassemble the OCXO Plate

2. Insert the OCXO module into the slot in the direction shown in the figure below, and ensure it is properly inserted. Fix the plate to the rear panel with two screws. Note that the side imprinted with "OCXO" letters should be positioned outward.

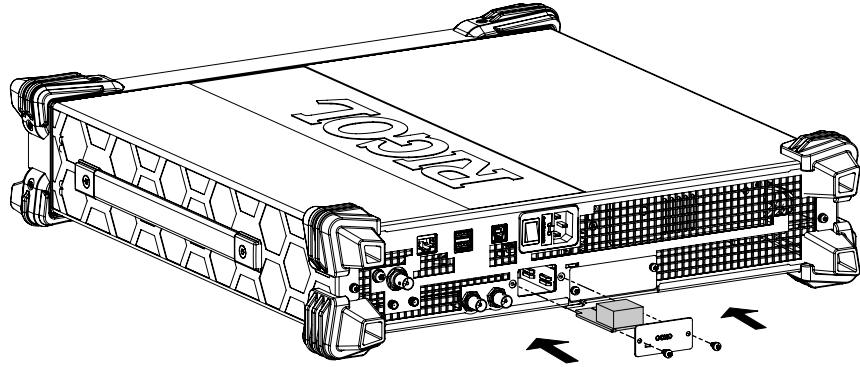

Figure 4.7 Fasten the Plate to the Rear Panel of the Signal Generator



WARNING

To avoid electric shock, please ensure that the instrument has been turned off and the power source is disconnected before installing the option.

4.7 Fuse Replacement

If you need to replace the fuse, use only the specified fuse and perform the following operations:

1. Turn off the instrument, cut off the power, and remove the power cord.
2. Use a small straight slotted screwdriver to pry out the fuse holder.
3. Take out the fuse holder.
4. Replace the old fuse with a specified fuse (AC 250 V, T3.15 A).
5. Install the fuse holder.

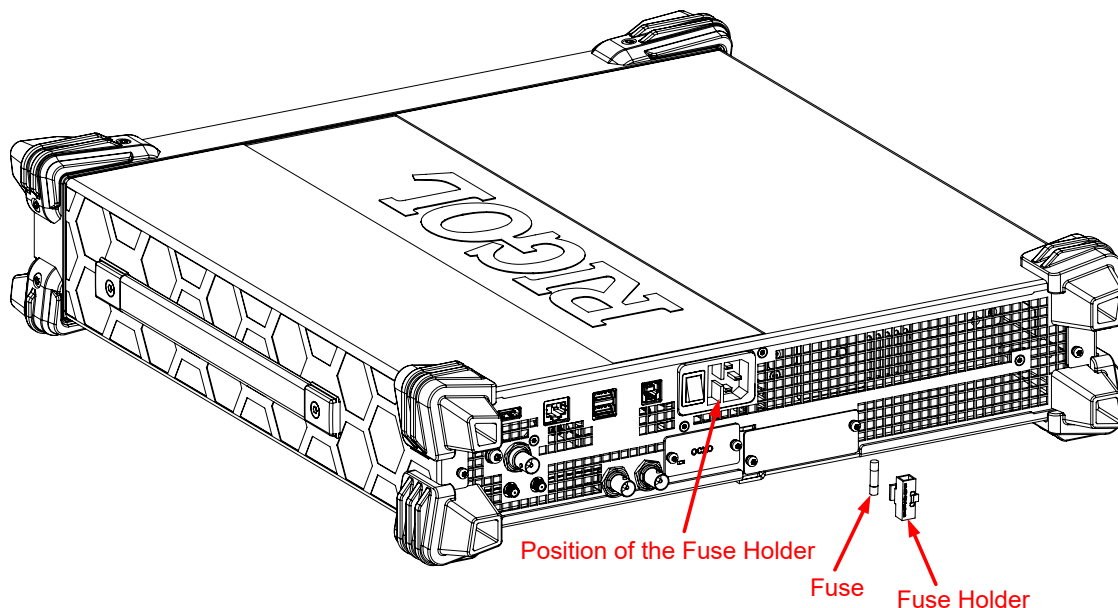

Figure 4.8 Fuse Replacement



WARNING

To avoid electric shock, please ensure that the instrument has been turned off, the power source has been cut off, and the fuse to be used conforms to the fuse rating.

4.8 User Interface

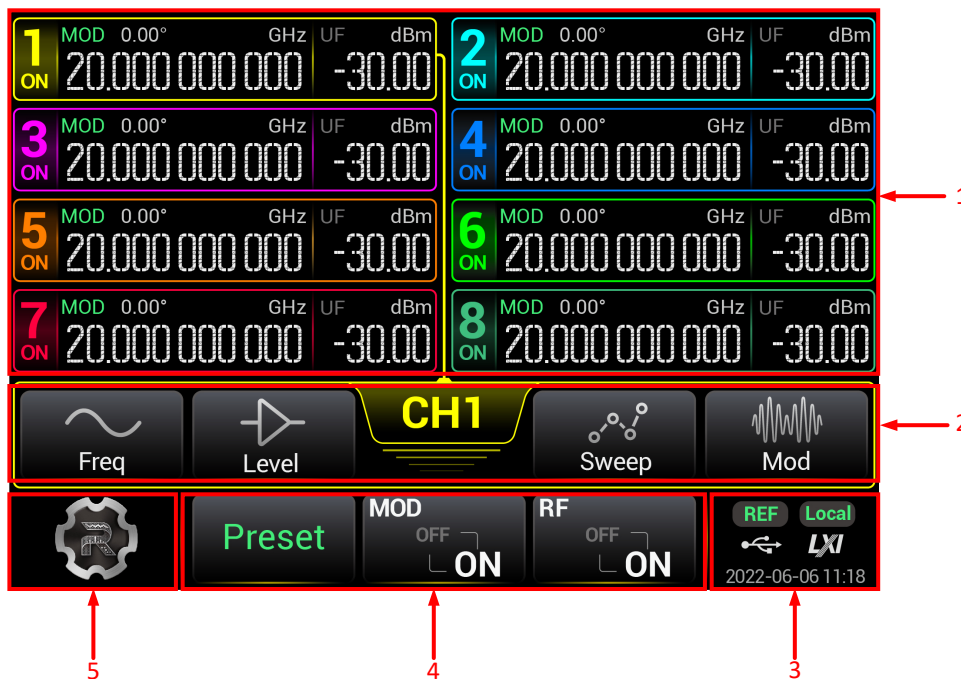

Figure 4.9 User Interface

1. RF Channel Display Area

- Displays the frequency, level, phase, modulation state, RF output state of each channel. It also shows which channel is selected.
- Each channel is indicated in different numbers and colors. The color of the channel is consistent with that of the RF output connector. The "ON" or "OFF" state under the channel No. indicates the RF output status of the specified channel. For each channel displayed in the main interface, the left section is its frequency display area, and the right section is its level display area.
- Click or tap a certain channel to select it. The menu items of the selected channel are enclosed by a check box whose color is the same as the that of channel. For example, when CH1 is selected, the check box for enclosing the parameters of CH1, the connecting line that connect the Channel No. and the channel parameters, the channel No., and the channel color are all indicated in yellow.
- Long press the specified channel area, the channel will be enabled or disabled. When enabled/disabled, the RF out of the channel will be enabled/disabled accordingly.
- MOD status indicates whether the modulation output is enabled for the specified channel. When the modulation output is enabled, if the RF output is enabled for the specified channel, "MOD" is illuminated. **MOD** is displayed in the channel display area. When the modulation output is disabled, "MOD" is in gray and **MOD** is displayed in the channel display area.
- The displayed contents and layout of the main interface are different for the instrument with different number of channels. For example, for a device with 2, 4, or 6 channels, you can view more function information of each channel such as Offset, Sweep, AM, FM, PM, and Pulse on/off status.



NOTE

The models with 2, 4, or 6 channels include DSG5202, DSG5122, DSG5204, DSG5124, DSG5206, and DSG5126.

2. RF Channel Setting Menu

Sets the parameters for the selected RF channel.

- **CH1:** indicates the currently selected channel.

When you select other channels, it displays the specified channel. The displayed color is the same as that of the channel.

Click or tap it to view more parameter information about this channel. Click or tap it again to close the single-channel information display.

- **Freq:** sets the frequency parameters.

Click or tap **Freq** to enter the frequency parameter setting interface. You can set the parameters such as frequency, frequency offset, and phase offset.

- **Level:** sets the level parameters.

Click or tap **Level** to enter the level parameter setting interface. You can set the parameters such as Level, Limit, Offset, and Flatness. You can also set the level unit.

- **Sweep:** sets the sweep parameters.



Click or tap **Sweep** to enter the signal sweep parameter setting interface. You can set the parameters such as sweep type, sweep mode, and others.

- **Mod:** sets the modulation parameters.

Click or tap **Mod** to enter the signal modulation parameter setting interface. You can select different modulation types and set the modulation parameters.

3. Status Display Area

Displays the system status, including the remote control status, LXI, date and time, etc.

- **Date:** displays the system date and time.
- **LXI:** indicates the LXI certification icon.
- **REF:** When the external 10 MHz reference clock is used, REF is displayed.
- **USB storage device icon:** When a USB storage device is detected,  will be displayed.
- **Operation Mode:**  indicates that the instrument is operating in remote control mode.  indicates that the instrument is operating in local mode.

4. Global Parameter Setting Area

The parameter settings in this area are global to all the channels or the whole system function.

- **Preset:** Performs the preset operation for the system to restore the system to its default settings or user defined settings.
- **MOD:** Enables or disables the modulation output for all the channels.
- **RF:** Enables or disables the RF signal output for all the channels. As long as the RF output of any one channel is enabled, the RF status shows ON. If the RF output of all the channels are disabled, the RF status shows OFF.



NOTE

- On the touch screen, tapping **MOD** can only enable or disable the modulation output for all the channels.
- If you need to enable or disable the modulation output for one specified channel or multiple channels, run the specified SCPI command to enable or disable the modulation output for a specified channel; also you can connect the instrument to an external display via the HDMI interface to operate. The operation procedures are as follows: In the external display, select a modulation type to enter the modulation interface. Select one channel and click MOD in the parameter setting area to enable or disable the modulation output for the channel. If enabled, **MOD** is displayed in the channel display area.

5. System Setting

Click or tap the system setting icon to enter the system setting interface. You can set the interface (e.g. LAN), perform system upgrade, view the system information, perform file operation, etc.

4.9 To Use the Built-in Help File

The built-in help file provides information about the functions and menu introductions of the instrument. You can view the help information for any function or menu during the instrument operation.

Click or tap  > **Help**. The help file is displayed. You can get its help information by clicking on the link for the introduction of the specified function.

5 Keypad Setting

For DSG5000 series, there are no physical keys except the power key button. All operations on the instrument can be completed with the touch screen. To set the parameters or edit the filename, use the numeric keypad or alphanumeric on-screen keypad.

5.1 Numeric Keypad for Setting Parameter Values

The numeric keypad is used to set the parameter values. The unit column lists the available units for the parameters.

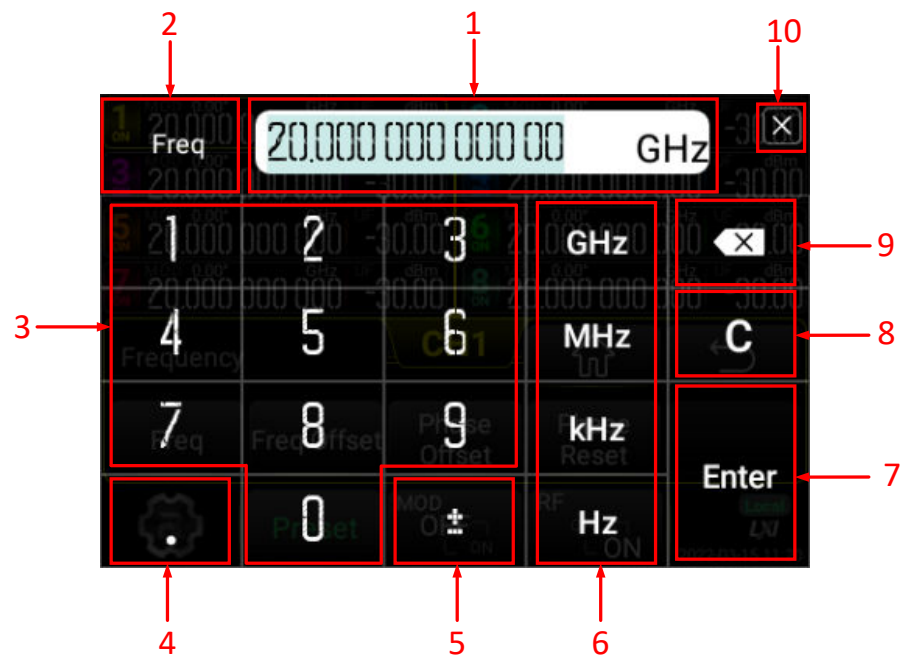

Figure 5.1 Numeric Keypad

1. Input Field

- Used to input the parameter value. The default unit is added after the value.
- Click or tap to move the cursor to a specified position to modify or delete the value.
- Once a parameter is modified, the value in the input field is updated immediately.

2. Parameter Name

Displays the parameter name to be set.

3. Numbers

Click or tap the numbers to input them into the parameter input field.

4. Decimal Point

- To input a decimal number less than 1, input the decimal point first and then add a number.
- To input a real number with decimals, input a real number first and then add a decimal point. The number of zero digits is automatically added after the decimal point according to the rules of the specified parameter.
- To input a non-integer number greater than 1, input a real number first and then add a decimal point, then add a number in the decimal part.
- It is not allowed to input several decimal points.

5. Plus or minus sign

Your first click or tap of the sign will input a minus (-) sign, the second time of click or tap of it will input a plus sign, but the plus sign is always omitted for the number display.

6. Unit

- The available units are different for different parameters.

Frequency: GHz, MHz, kHz, Hz

Level:

When the level unit is set to "dBm", the units displayed in the unit column of the numeric keypad are dBm, V, mV, and uV;

When the level unit is set to "dBmV", the units displayed in the unit column of the numeric keypad are dBmV, V, mV, and uV;

When the level unit is set to "V", the units displayed in the unit column of the numeric keypad are V, mV, uV, and dBm;

When the level unit is set to "W", the units displayed in the unit column of the numeric keypad are W, mW, uW, and dBm;

Level Offset: dB

Time: s, ms, us, ns

Phase: deg

Depth: %

Phase Deviation: rad

- After inputting the number, select the desired unit to complete the input of the parameter setting. Then it automatically goes to the previous page.
- After inputting the number, click or tap **Enter** to confirm the input and the default unit is added. Then it automatically goes to the previous page.
- If you do not edit the parameter value and only select the unit, then the channel display area shows the parameter value, with the unit changed and the value unchanged.

7. Enter

After inputting the value and selecting the unit, click or tap Enter directly to confirm the parameter input. If you do not select the unit for the value, clicking or tap Enter, by default, the current unit is added. Then it automatically goes to the previous page.

8. Clear

Click or tap C to clear all the input.

9. Delete

Click or tap this icon to clear the input. Move the cursor to the position of the number that needs to be deleted, then click or tap this icon to clear the digit ahead of the cursor.

10. Close Icon

Close the numeric keypad and no changes are made to the parameter. Then the system goes to the previous page automatically.

5.2 Alphanumeric Keypad for Filename Input

The keypad supports Chinese, English, and numeric input methods. You can click or tap CN/1/EN to switch among the three input methods. It is mainly used to input the filename.

Chinese Character Input

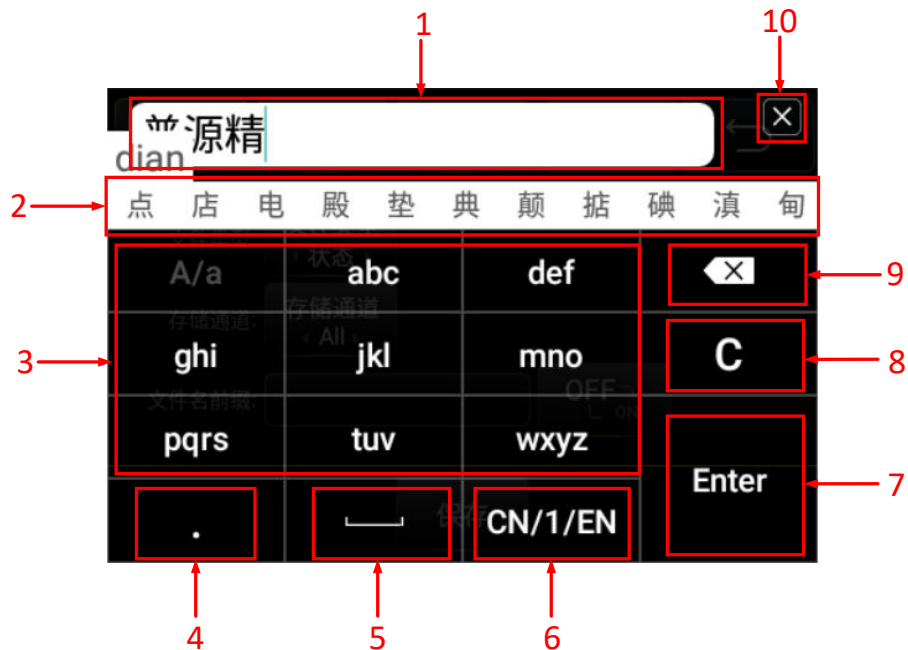

Figure 5.2 Chinese Character Input

1. Input Field

Displays the input contents.

2. Association Area

- Pinyin Input Association Area

For the Chinese input methods, after you have input several letters, it will associate the related Pinyin and display them in this area.

- Chinese Character Association Area

Displays the associated Chinese characters or phrases that the current Pinyin input has indicated.

You can slide to move left and right to display the associated Chinese characters or phrases.

Click or tap the desired Chinese characters or phrases, then they will be input into the field.

3. Pinyin Input Area

Click or tap to input Pinyin, the rules for inputting Pinyin are illustrated by "abc" item.

- Your first click or tap will display the first letter a.

- After the first click or tap ($<t$), click or tap the item again, a will change to b in the Pinyin association area.
- After a specified time ($\geq t$), your click or tap will display the first letter a again.

4. Decimal Point

Click or tap it to insert a decimal point "." at the cursor position. You are allowed to input several decimal points. It can be input in English input state or numeric input state.

5. Space

- Space is allowed to be input in the middle position of the filename, and you are allowed to input several spaces.
- It is allowed to input space before or after the filename when editing. However, when you confirm the input, the space added before or after the filename will be omitted by default.

6. Input Method Switch

- The first item before the slash shows the current input method. For example, CN/1/EN indicates that the current input method is Chinese character input.
- Click or tap to switch to the next input method. When it is Chinese character input, one click or tap will switch the input method to numeric input method.
- When switching the input method, the input contents that have already existed in the input field will not be affected.

7. Enter

After inputting the file or folder name, click or tap Enter directly to confirm the name input. Then it automatically goes to the previous page.

8. Clear

Click or tap C to clear all the input.

9. Delete

Click or tap this icon to clear the input. Move the cursor ahead of the item that needs to be deleted, then click or tap this icon to clear the item.

10. Close Icon

Close the keypad and no changes are made. Then the system goes to the previous page automatically.

English Letter Input

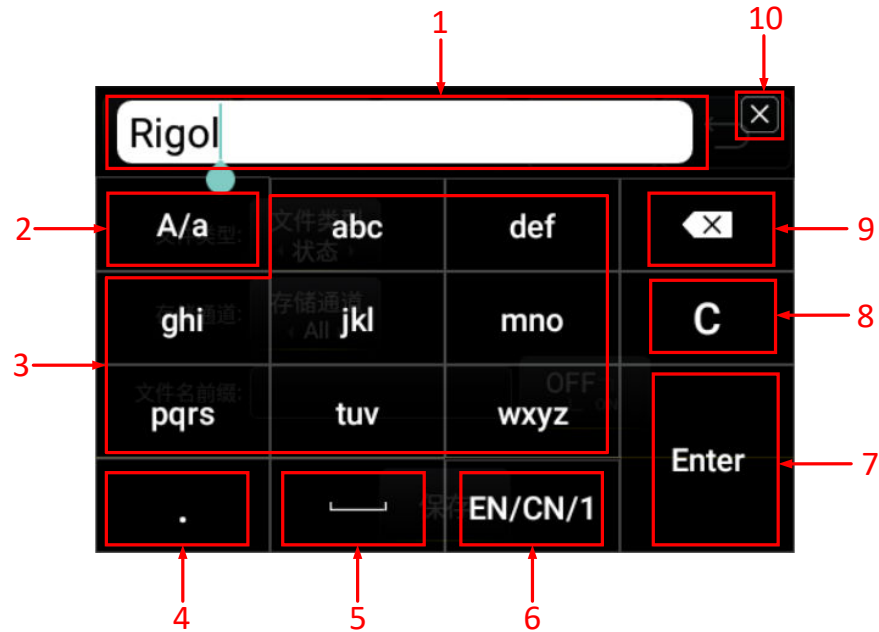

Figure 5.3 English Letter Input

1. Input Field

Displays the input contents.

2. Upper-lower Case Switch

Click or tap it to switch between the uppercase letter and the lowercase letter.

- When switched to uppercase, all the letters displayed in the keypad are in uppercase form. At this time, click or tap the item to input the uppercase letter.
- When switched to lowercase, all the letters displayed in the keypad are in lowercase form. At this time, click or tap the item to input the lowercase letter.

3. Letter Input Area

- The uppercase/lowercase form of letters displayed in this area is determined by the setting of A/a item. When in uppercase form, all the letters are capitalized, e.g. "ABC"; when in lowercase form, all the letters are not capitalized, e.g. "abc".
- The input rules are as follows:

take the input of abc as an example. You first click or tap will input the first letter "a".

After the first click or tap (<t), click or tap the item again, "a" will change to "b", and so on.

After a specified time ($\geq t$), your click or tap will display the first letter "a" again.

4. Decimal Point

Click or tap it to insert a decimal point "." at the cursor position. You are allowed to input several decimal points. It can be input in English input state or numeric input state.

5. Space

- Space is allowed to be input in the middle position of the filename, and you are allowed to input several spaces.
- It is allowed to input space before or after the filename when editing. However, when you confirm the input, the space added before or after the filename will be omitted by default.

6. Input Method Switch

- The first item before the slash shows the current input method. For example, CN/1/EN indicates that the current input method is Chinese character input.
- Click or tap to switch to the next input method. When it is Chinese character input, one click or tap will switch the input method to numeric input method.
- When switching the input method, the input contents that have already existed in the input field will not be affected.

7. Enter

After inputting the file or folder name, click or tap Enter directly to confirm the name input. Then it automatically goes to the previous page.

8. Clear

Click or tap C to clear all the input.

9. Delete

Click or tap this icon to clear the input. Move the cursor ahead of the item that needs to be deleted, then click or tap this icon to clear the item.

10. Close Icon

Close the keypad and no changes are made. Then the system goes to the previous page automatically.

Number Input



Figure 5.4 Number Input Keypad

6 Frequency

6.1 Frequency Setting

Sets the RF output frequency.

Click or tap **Freq** > **Freq**. Input the frequency value with the pop-up numeric keypad, and select the desired unit.

- The frequency units available are GHz, MHz, kHz, and Hz.
- You can also directly click or tap **Enter** to confirm the default unit for the frequency.
- You can click or tap the input field of the Freq parameter to edit the value or move the cursor to the specified position to modify the value.

6.2 Freq Offset

Sets the frequency offset relative to the RF output frequency.

When using an external mixer and other devices, you can set and read the frequency value through the external mixer on the RF source by setting the frequency offset.

Click or tap **Freq** > **Freq Offset**. Input the frequency offset value with the pop-up numeric keypad, and select the desired unit.

- The frequency offset units available are GHz, MHz, kHz, and Hz.
- You can also directly click or tap **Enter** to confirm the default unit for the frequency offset.
- You can click or tap the input field of the Phase Offset parameter to edit the value or move the cursor to the specified position to modify the value.



NOTE

1. When the frequency offset is 0 Hz, the frequency displayed in the interface (namely the setting frequency) is equal to the actual output frequency.
2. When the frequency offset is not 0 Hz, the output frequency is determined by the setting frequency and frequency offset. The three parameters satisfy the following equation:
Setting frequency (display frequency) = output frequency + frequency offset
3. The deviation (namely the actual output frequency) between the display frequency and frequency offset cannot exceed the frequency range of instrument.

6.3 Phase Offset

Sets the phase offset of the RF signal. You can adjust the phase offset to synchronize the phase of the output signals or set a fixed phase offset for the signals.

Click or tap **Freq** > **Phase Offset**. Input the phase offset value with the pop-up numeric keypad, then select the desired unit **deg**.

- The available phase offset unit is deg.
- You can directly click or tap **Enter** to confirm to select the default unit "deg" after setting the phase offset value.
- You can click or tap the input field of the Phase Offset parameter to edit the value or move the cursor to the specified position to modify the value.

6.4 Phase Reset

Resets the current phase offset to 0 deg.

Click or tap **Freq** > **Phase Reset** to reset the current phase offset to 0 deg. Then 0 deg is displayed in the channel display area.

7 Amplitude

7.1 Amplitude Setting

Sets the RF output amplitude.

Click or tap **Level** > **Level**. Input the amplitude value with the pop-up numeric keypad, and select the desired unit.

- The amplitude units available are dBm, V, mV, and uV.
- You can directly click or tap **Enter** to confirm the default unit for the amplitude.
- You can click or tap the input field of the Level parameter to edit the value or move the cursor to the specified position to modify the value.

7.2 Amplitude Limit

Sets the limit of the RF output amplitude. This value is the upper limit of the RF output amplitude.

To limit the output amplitude, you can use the amplitude limit function to avoid damage caused by delivering a high-powered signal to the external circuit.

Click or tap **Level** > **Limit**. Input the amplitude limit with the pop-up numeric keypad, and select the desired unit.

- The amplitude limits of units available are dBm, V, mV, and uV.
- You can directly click or tap **Enter** to confirm the default unit dBm for the amplitude limit.
- You can click or tap the input field of the Limit parameter to edit the value or move the cursor to the specified position to modify the value.

7.3 Amplitude Offset

Sets the amplitude offset relative to the RF output amplitude.

If the external device or circuit has a fixed attenuation or gain, by setting the amplitude offset, you can set and read the amplitude value from the microwave signal generator after the signal has been attenuated or gained.

Click or tap **Level** > **Offset**. Input the amplitude offset value with the pop-up numeric keypad, and select the desired unit.

- The available amplitude offset unit is dB.
- You can directly click or tap **Enter** to confirm the default unit for the amplitude offset.
- You can click or tap the input field of the Offset parameter to edit the value or move the cursor to the specified position to modify the value.



NOTE

1. When the amplitude offset is 0 dB, the display amplitude (namely the setting amplitude) is equal to the actual output amplitude.
2. When the amplitude offset is not 0 dB, the output amplitude is determined by the setting amplitude and amplitude offset. The three parameters satisfy the following equation:

$$\text{setting amplitude (display amplitude)} = \text{output amplitude} + \text{amplitude offset}$$
3. The deviation (namely the actual output amplitude) between the display amplitude and amplitude offset cannot exceed the amplitude range of instrument.
4. The current amplitude range of instrument is related to the amplitude limit and RF output frequency.

7.4 Flatness Calibration

The flatness calibration function can adjust the RF output amplitudes corresponding to the frequency points within the frequency range of the instrument to compensate for the external loss caused by the cables, switches or other devices. You can load the flatness calibration lists stored in the internal or external memory to the instrument, and view the list.

Set the Flatness Calibration State

Click or tap **Level** > **Flatness**. Then click or tap **Switch** to select "ON" or "OFF" to enable or disable the flatness calibration function. When the flatness calibration is enabled, the "UF" status is illuminated in the channel display area of the user interface.

Load the Flatness Calibration List

Click or tap **Level** > **Flatness** > **Load**. Select the flatness calibration list (the file suffixed with "*.csv") to be loaded from the disk. Then click or tap **Load** at the right side of the interface to load the flatness calibration list data.

The format of the flatness calibration list file to be loaded is shown below.

SN	Freq	Level ^[1]
1	207.85400000 MHz	-0.50 dB

SN	Freq	Level ^[1]
2	304.00000000 MHz	7.45 dB
3	800.00000000 MHz	-17.80 dB

NOTE

^[1]: Amplitude calibration value. When calibrating the amplitude at the current frequency point, only the actual output amplitude will be affected and the amplitude display value will not change.

TIP

You need to use the Excel to generate the file suffixed with "*.csv". Then open the file, and edit the parameters directly in the Excel file. Save it to the USB storage device. You can store the file to the instrument via USB or FTP, and load the file to the instrument when needed.

View Flatness Calibration List

Click or tap **Level** > **Flatness** > **View** to view the loaded flatness calibration list of the instrument. When no files are loaded, it shows the default flatness calibration list of the instrument.

NOTE

You can also use the HDMI-connected external display or the SCPI command to edit the flatness correction list, perform loading, saving, insertion, deletion operation.

7.5 Amplitude Unit

Sets the unit of the RF output amplitude.

Click or tap **Level** > **Unit** to select the desired unit.

The output amplitude units available are dBm, dBmV, dBuV, V and W. Wherein, dBm, dBmV, and dBuV are for Log scale; V and W are for Linear scale. The default unit is dBm.

8 Sweep

When the sweep function is enabled, the signal generator outputs the sweep signal from the front-panel [RF 50Ω] connector (at this point, RF output should be enabled).

8.1 Sweep Function

The instrument provides three types of sweep functions ("Freq", "Level", and "Freq & Level"). The sweep function is enabled when any of the sweep types is selected. By default, the sweep function is disabled.

Click or tap **Sweep** > **Sweep** to select the desired sweep function.

- **Off:** the default state, indicating that the sweep function is disabled.
- **Freq:** enables the frequency sweep function. At this point, the left part of the channel display area shows the frequency sweep progress and the variation of the frequency values.
- **Level:** enables the amplitude sweep function. At this point, the right part of the channel display area shows the amplitude sweep progress and the variation of the amplitude values.
- **Freq & Level:** simultaneously enables the frequency and amplitude sweep function. At this point, the left part of the channel display area shows the frequency sweep progress and the variation of the frequency values; the right part of the channel display area shows the amplitude sweep progress and the variation of the amplitude values.

8.2 Sweep Type

The instrument provides two sweep types ("List" and "Step"). By default, it is "Step".

8.2.1 Step Sweep

Set the Sweep Type

Click or tap **Sweep** > **Type** to select "Step". At this point, the microwave signal generator starts to perform the step sweep according to the current settings.

Set the Sweep Parameters

Click or tap **Sweep** > **Setting** to set the start frequency, stop frequency, start level, stop level, sweep points, dwell time, shape/space, direction, etc.

1. Start Freq

Click or tap **Freq/Level** > **Start Freq**, input the value of the start frequency with the pop-up numeric keypad and select the desired unit. You can also just input the dwell time value, then click or tap **Enter** to confirm the value and the current dwell time unit is selected by default.

2. Stop Freq

Click or tap **Freq/Level** > **Stop Freq**, input the value of the stop frequency with the pop-up numeric keypad and select the desired unit. You can also just input the dwell time value, then click or tap **Enter** to confirm the value and the current dwell time unit is selected by default.

NOTE

- Start frequency and stop frequency are the upper and lower limits of the frequency for frequency sweep.
- When the sweep direction is "Fwd", the microwave signal generator sweeps from start frequency to stop frequency. When the sweep direction is "Down", the microwave signal generator sweeps from stop frequency to start frequency.
- After modifying the "start frequency" or "stop frequency", the microwave signal generator will restart to sweep from the specified start frequency or stop frequency.

3. Start Level

Click or tap **Freq/Level** > **Start Level**, input the value of the start level with the pop-up numeric keypad and select the desired unit. You can also just input the dwell time value, then click or tap **Enter** to confirm the value and the current dwell time unit is selected by default.

4. Stop Level

Click or tap **Freq/Level** > **Stop Level**, input the value of the stop level with the pop-up numeric keypad and select the desired unit. You can also just input the dwell time value, then click or tap **Enter** to confirm the value and the current dwell time unit is selected by default.

NOTE

- Start level and stop level are the upper and lower limits of the level for level sweep.
- When the sweep direction is "Fwd", the microwave signal generator sweeps from start level to stop level. When the sweep direction is "Down", the microwave signal generator sweeps from stop level to start level.
- After modifying the "start level" or "stop level", the microwave signal generator will restart to sweep from the specified start level or stop level.

5. Sweep Points

Click or tap **Points**, input the number of sweep points with the pop-up numeric keypad, then click or tap **Enter** to confirm the input. You can select the number unit for the number of sweep points. By default, the number of sweep points is 11.

6. Dwell Time

Indicates the duration of a sweep step.

Click or tap **Dwell Time**, then input the dwell time with the pop-up keypad. Select the desired unit. The available units are s, ms, μ s, and ns. The range of the dwell time is from 5 ms to 100 s. You can also just input the dwell time value, then click or tap **Enter** to confirm the value and the current dwell time unit is selected by default.

7. Sweep Shape

Indicates the waveform shape of the sweep signal.

Click or tap **Shape/Space** > **Shape** to select "Tri" or "Ramp".

- **Ramp:** the sweep period always starts from the start frequency/start level to the stop frequency/stop level. The sweep shape is similar to a Ramp waveform.
- **Tri:** the sweep period always starts from the start frequency/start level to the stop frequency/stop level, and then returns back to the start frequency/start level. The sweep shape is similar to a Triangle waveform.

When the sweep direction is "Fwd", the "Ramp" and "Tri" sweep shape is shown in *Figure 8.1*.

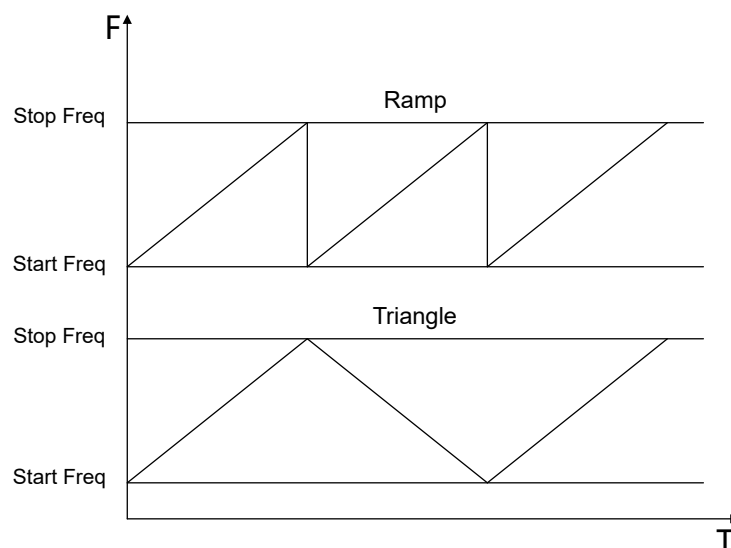

Figure 8.1 Diagram of the Sweep Shape in "Fwd" Sweep Direction

8. Sweep Space

Indicates the mode in which the instrument changes from one frequency/amplitude to another within one step.

Click or tap **Shape/Space** > **Space** to select "Lin" or "Log".



TIP

The level sweep only supports the "Lin" sweep space.

9. Sweep Direction

Click or tap **Direction** to select "Fwd" or "Down". By default, it is "Fwd".

- **Fwd:** the microwave signal generator sweeps from the start frequency/start level to stop frequency/stop level. The frequency display area and level display area of the specified channel in the main interface show the sweep progress, moving from left to right.
- **Down:** the microwave signal generator sweeps from stop frequency/stop level to start frequency/start level. The frequency display area and level display area of the specified channel in the main interface show the sweep progress, moving from right to left.

8.2.2 List Sweep

Select the List Sweep Mode

Click or tap **Sweep** > **Type** to select "List". At this point, the RF signal generator sweeps according to the current sweep list.

Load the Sweep List

Click or tap **Setting** > **Load**. Select the sweep list (the file suffixed with "*.csv") to be loaded from the disk, then click or tap **Load** at the right side of the interface. The instrument will load the sweep list data.

The format of the sweep list file to be loaded is shown below.

SN	Freq ^[1]	Level ^[2]	Dwell Time ^[3]
1	2.00000000010 GHz	-10.00 dBm	500.00 ms
2	1.99415268700 GHz	0.00 dBm	500.00 ms
3	1.88800000000 GHz	10.00 dBm	500.00 ms

**NOTE**

[1]: Indicates the frequency value at the set frequency point. The default unit is Hz.

[2]: Indicates the amplitude value at the set frequency point. The default unit is dBm.

[3]: Indicates the duration of a sweep step. The default unit is s.

**TIP**

You need to use the Excel to generate the file suffixed with "*.csv". Then open the file, and edit the parameters directly in the Excel file. Save it to the USB storage device. You can store the file to the instrument via USB or FTP, and load the file to the instrument when needed.

View the Sweep List

Click or tap **Setting** > **View** to view the currently loaded sweep list. When no files are loaded, it shows the default sweep list of the instrument.

**NOTE**

You can also use the HDMI-connected external display or the SCPI Pulse edit the sweep list, perform loading, saving, insertion, deletion operation.

8.3 Sweep Mode

Click or tap **Sweep** > **Mode** to set the sweep mode, execute single sweep, and reset sweep settings.

Sweep Mode

Click or tap **Mode** > **Mode** to select "Cont" or "Single" as the sweep mode. By default, it is "Cont".

- **Cont:** When "Cont" is selected, the continuous sweep label is displayed in the channel display area. The instrument sweeps continuously according to the current setting when the trigger condition is met.
- **Single:** When "Single" is selected, the single sweep label is displayed in the channel display area. The instrument performs a single sweep according to the current setting and then stops when the trigger condition is met.

Single Sweep

If the current sweep mode is "Continuous", click or tap **Mode** > **Single** to switch the sweep mode to "Single". The instrument starts a single sweep if the trigger condition is currently met.

If the current sweep mode is "Single", click or tap **Mode** > **Single**. The instrument starts a sweep if the trigger condition is met.

Sweep Reset

If the current sweep direction is "Fwd", click or tap **Mode** > **Sweep Reset**, the instrument stops the current sweep and restarts the sweep from the start frequency or start level.

If the current sweep direction is "Down", click or tap **Mode** > **Sweep Reset**, the instrument stops the current sweep and restarts the sweep from the stop frequency or stop level.



NOTE

If the instrument is sweeping with RF being disabled, then when you enable RF, the instrument will reset the sweep, that is, stop the current ongoing sweep and restart to sweep.

8.4 Trigger

Click or tap **Sweep** > **Trigger** to set the trigger-related parameters.

Trigger Type

Sets the trigger type for the whole sweep period.

Click or tap **Trigger** > **Trigger Type** to select "Auto", "Key", "Bus", or "Ext".



NOTE

The following descriptions are valid when the trigger type of each sweep point in the sweep period is met.

- **Auto Trigger**

By default, the trigger type is "Auto". If the sweep mode is set to "Cont", the instrument will start sweeping once a sweep type is selected. If the sweep mode is set to "Single", click or tap **Single** to meet the single sweep condition first and then the instrument will start a sweep and then stops.

- **Key Trigger**

After selecting "Key" trigger, if the sweep mode is set to "Cont", the instrument starts a sweep each time you click or tap **Key**. If the sweep mode is "Single", click or tap **Single** to meet the single sweep condition. After that the instrument starts a sweep and then stops each time you click or tap **Key**.

- **Bus Trigger**

After selecting "Bus" trigger, if the sweep mode is set to "Cont", the instrument starts a sweep each time the "*TRG" command is sent. If the sweep mode is

"Single", click or tap **Single** to meet the single sweep condition. After that the instrument starts a sweep and then stops each time the "*TRG" command is sent.

- **External Trigger**

After selecting "Ext" trigger, the RF signal generator receives the trigger signal input from the front-panel [TRIGGER] connector. If the sweep mode is set to "Cont", the instrument starts a sweep each time a TTL pulse signal with specified polarity is received. If the sweep mode is "Single", click or tap **Single** to meet the single sweep condition. After that the instrument starts a sweep and then stops each time a TTL pulse signal with the specified polarity is received.

TIP

To specify the polarity of the TTL pulse signal, click or tap **Trig Slope** to select "Pos" or "Neg". By default, it is "Pos".



Point Trigger Type

Sets the trigger type for each sweep point in a sweep period.

Click or tap **Trigger** > **Point Trigger Type** to select "Auto", "Key", "Bus", or "Ext".

NOTE

The following descriptions are valid when the trigger mode in the sweep period is met.



- **Auto Trigger**

By default, the trigger type is "Auto". If the sweep mode is "Continuous", select one sweep type and the instrument sweeps each sweep point continuously within a sweep period. If the sweep mode is "Single", you need to click or tap **Single** first to meet the single sweep condition, and then it will launch one sweep period and then stops.

- **Key Trigger**

After selecting "Key" trigger, if the sweep mode is set to "Cont", the instrument starts to sweep a point each time you click or tap **Key**. If the sweep mode is "Single", click or tap **Single** to meet the single sweep condition. After that the instrument sweeps a point each time you click or tap **Key**, then it stops till one sweep period is completed.

- **Bus Trigger**

After selecting "Bus" trigger, if the sweep mode is set to "Cont", the instrument sweeps a point each time the "*TRG" command is sent. If the sweep mode is "Single", click or tap **Single** to meet the single sweep condition. After that the

instrument starts to sweep a point each time the "*TRG" command is sent. Then it will stop till one sweep period is completed.

- **External Trigger**

After selecting "Ext" trigger, the RF signal generator receives the trigger signal input from the front-panel [TRIGGER] connector. If the sweep mode is "Continuous", every time the instrument receives a TTL pulse signal with the specified polarity, the instrument starts to sweep one point. If the sweep mode is "Single", you need to click or tap **Single** to meet the single sweep condition. At this point, each time the instrument receives a TTL pulse signal with the specified polarity, it sweeps one point and then stops after completing one sweep period.

**TIP**

To specify the polarity of the TTL pulse signal, click or tap **Trig Slope** to select "Pos" or "Neg". By default, it is "Pos".

**NOTE**

To optimize the sweep performance, when the external trigger period is too small, the displayed data on the screen may not be synchronously updated with the actual output data.

9 Modulation

Click or tap **Mod** to set AM, FM, PM, and Pulse modulation parameters.

9.1 Amplitude Modulation (AM)

For amplitude modulation (AM), the amplitude of the RF carrier waveform varies with the the modulating signal linearly. This function is required to install the option DSG5000-AMD.

9.1.1 To Enable the Amplitude Modulation

Click or tap **AM** > **Switch** to select "ON" or "OFF".

- **ON:** enables the AM function.
- **OFF:** disables the AM function. This is the default state.

9.1.2 To Select the Modulation Source

Click or tap **AM** > **Source** to select "Int" or "Ext" as the modulation source.

- **Internal**

When you select "Int", the internal modulation source is enabled. At this time, the instrument provides the modulating signal and can set its modulation frequency and modulation waveform.

- **External**

When the external modulation source is selected, **Freq** and **Waveform** are grayed out and disabled. The signal generator receives the external modulating signal input from the rear-panel [**EXT MOD IN**] connector. The modulating signal can be arbitrary waveforms.



NOTE

To ensure the modulation performance, the input amplitude of the external modulating signal should be less than ± 0.5 V.

9.1.3 To Set the Modulation Depth

Modulation depth indicates the output amplitude variation. It is expressed in percentage. The range of AM modulation depth is from 0% to 100%.

1. When the internal modulation source is selected,

AM modulation depth m_a and the amplitude deviation ΔP_{sb} between CW and sidebands satisfy the following equation:

$$\Delta P_{sb} = 6-20 \lg m_a$$

- When modulation depth is 0%, the instrument outputs a single carrier waveform signal at a single frequency point.
- The greater the modulation depth, the smaller the difference between the output amplitude and carrier amplitude; the better the symmetry of the output amplitudes of the Up Side Band (USB) and Lower Side Band (LSB).

2. When the internal modulation source is selected,

- 100% modulation depth refers to the modulation depth corresponding to 0.5 V input amplitude of the external modulation source.
- When the input amplitude of the external modulation source is 0.25 V, the modulation depth actually measured is 50%.

9.1.4 To Set the Modulation Frequency

Click or tap **AM** > **Freq**. Input the modulation frequency value with the pop-up numeric keypad, and select the desired unit. You can also directly click or tap **Enter** to confirm the default unit for the frequency.

- The modulation frequency range of Sine waveform is from 10 Hz to 100 kHz.
- The modulation frequency range of Square waveform is from 10 Hz to 20 kHz.



NOTE

When the external modulation source is selected, this menu will be grayed out and disabled.

9.1.5 To Set Other AM-related Parameters

Click or tap **AM** > **Setting** to set the modulating waveform, coupling mode, impedance, and equal level setting.

Modulating Waveform

When you select the internal modulation source, Click or tap **Setting** > **Waveform** to select "Sine" or "Square". By default, it is "Sine".

External Coupling

When you select the external modulation source, click or tap **Setting** > **Coupling** to select "AC" or "DC". The default is "AC".

- **AC:** When "AC" is selected, the DC components of the external signal input from the rear-panel **[EXT MOD IN]** connector of the instrument will be blocked and the AC components can pass through the connector. The external modulation input port is similar to a high-pass filter whose low limit of the cutoff frequency is less than 5 Hz.
- **DC:** When "DC" is selected, all the AC components and DC components of the external input signal can pass through the connector.

Input Impedance

When the external modulation source is selected, click or tap **Setting** > **Impedance** to select "50Ω", "600Ω", or "HighZ" for setting the impedance of the **[EXT MOD IN]** connector.

NOTE

- When you select the internal modulation source, **Coupling** and **Impedance** are grayed out and disabled.
- When you select the external modulation source, **Waveform** is grayed out and disabled.

Equal Level

The equal level output function is available under the AM menu. That is, when AM modulation is used in setting the amplitude value for the continuous waveforms, the output signal peak remains unchanged, as shown in *Figure 9.1*.

Click or tap **Setting** > **Amplitude** to select "ON" or "OFF".

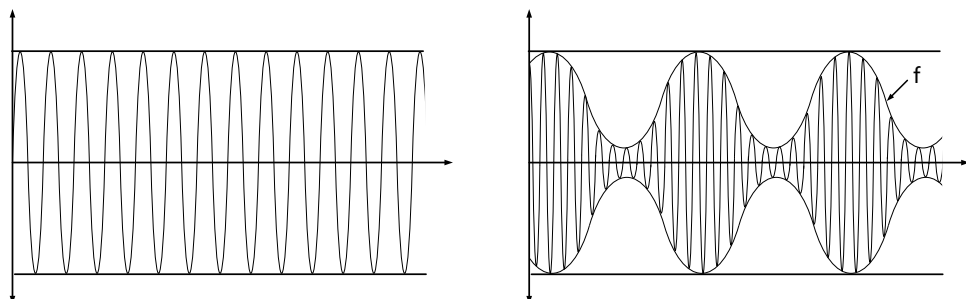

Figure 9.1 Diagram of Equal Level Output

**NOTE**

- This function is only valid when the amplitude modulation, MOD, and equal level output are enabled.
- When AM and other modulation functions are enabled, the equal level output is disabled automatically and invalid.
- This function, by default, is disabled.

9.2 Frequency Modulation (FM)

For frequency modulation (FM), the frequency of the RF carrier waveform varies with the modulating signals. This function is required to install the option DSG5000-AMD.

9.2.1 To Enable the Frequency Modulation

Click or tap **FM** > **Switch** to select "ON" or "OFF".

- **ON:** enables the FM function.
- **OFF:** disables the FM function. This is the default state.

**NOTE**

The frequency modulation and phase modulation cannot be enabled at the same time.

9.2.2 To Select the Modulation Source

Click or tap **FM** > **Source** to select "Int" or "Ext" as the modulation source.

- **Internal**

When you select "Int", the internal modulation source is enabled. At this time, the instrument provides the modulating signal and you can set its modulation frequency and modulation waveform.

- **External**

When the external modulation source is selected, **Rate** and **Waveform** are grayed out and disabled. The signal generator receives the external modulating signal input from the rear-panel **[EXT MOD IN]** connector. The modulating signal can be arbitrary waveforms.

**NOTE**

To ensure the modulation performance, the input amplitude of the external modulating signal should be less than ± 0.5 V.

9.2.3 To Set the Frequency Deviation

The frequency deviation is the deviation of the frequency of the modulating waveform from that of the carrier waveform. The unit is Hz.

Click or tap **FM** > **Deviation** to set the FM frequency deviation.

- Input the frequency deviation value with the pop-up numeric keypad, and select the desired unit.
- Different frequency settings of the carrier waveform correspond to different maximum frequency deviation.

9.2.4 To Set the Modulation Rate

When the modulation source is selected, click or tap **Rate** to set the modulation rate.

- Input the modulation rate with the pop-up numeric keypad, and select the desired unit.
- The range of the modulation rate of Sine waveform is from 10 Hz to 100 kHz.
- The range of the modulation rate of Square waveform is from 10 Hz to 20 kHz.



NOTE

When the external modulation source is selected, this menu will be grayed out and disabled.

9.2.5 To Set Other FM-related Parameters

Click or tap **FM** > **Setting** to set the modulating waveform, coupling mode, and impedance.

Modulating Waveform

Click or tap **Setting** > **Waveform** to select "Sine" or "Square". By default, it is "Sine".

External Coupling

When you select the external modulation source, click or tap **Setting** > **Coupling** to select "AC" or "DC". The default is "AC".

- **AC:** When "AC" is selected, the DC components of the external signal input from the rear-panel **[EXT MOD IN]** connector of the instrument will be blocked and the AC components can pass through the connector. The external modulation

input port is similar to a high-pass filter whose low limit of the cutoff frequency is less than 5 Hz.

- **DC:** When "DC" is selected, all the AC components and DC components of the external input signal can pass through the connector.

Input Impedance

When the external modulation source is selected, click or tap **Setting > Impedance** to select "50Ω", "600Ω", or "HighZ" for setting the impedance of the [EXT MOD IN] connector.



NOTE

- When you select the internal modulation source, **Coupling** and **Impedance** are grayed out and disabled.
- When you select the external modulation source, **Waveform** is grayed out and disabled.

9.3 Phase Modulation (PM)

Phase modulation (PM) indicates that the phase of the RF carrier waveform varies with the modulating signal. This function is required to install the option DSG5000-AMD.

9.3.1 To Enable the Phase Modulation

Click or tap **PM > Switch** to select "ON" or "OFF".

- **ON:** enables the PM function.
- **OFF:** disables the PM function. This is the default state.



NOTE

The frequency modulation and phase modulation cannot be enabled at the same time.

9.3.2 To Select Modulation Source

Click or tap **PM > Source** to select "Int" or "Ext" as the modulation source.

- **Internal**

When you select "Int", the internal modulation source is enabled. At this time, the instrument provides the modulating signal and you can set its modulation frequency and modulation waveform.

- **External**

When the external modulation source is selected, **Rate** and **Waveform** are grayed out and disabled. The signal generator receives the external modulating signal input from the rear-panel **[EXT MOD IN]** connector. The modulating signal can be arbitrary waveforms.

**NOTE**

To ensure the modulation performance, the input amplitude of the external modulating signal should be less than ± 0.5 V.

9.3.3 To Set the Phase Deviation

The phase deviation is the deviation of the phase of the modulating waveform relative to that of the carrier waveform. The unit is in rad.

Click or tap **PM** > **Deviation** to set the phase deviation.

- Input the phase deviation value with the pop-up numeric keypad, and select the desired unit.
- Different frequency settings of the carrier waveform correspond to different maximum phase deviation.

9.3.4 To Set the Modulation Rate

When the modulation source is selected, click or tap **Rate** to set the modulation rate.

- Input the modulation rate with the pop-up numeric keypad, and select the desired unit.
- The range of the modulation rate of Sine waveform is from 10 Hz to 100 kHz.
- The range of the modulation rate of Square waveform is from 10 Hz to 20 kHz.

**NOTE**

When the external modulation source is selected, this menu will be grayed out and disabled.

9.3.5 To Set Other PM-related Parameters

Click or tap **PM** > **Setting** to set the modulating waveform, coupling mode, and impedance.

Modulating Waveform

Click or tap **Setting** > **Waveform** to select "Sine" or "Square". By default, it is "Sine".

External Coupling

When you select the external modulation source, click or tap **Setting** > **Coupling** to select "AC" or "DC". The default is "AC".

- **AC:** When "AC" is selected, the DC components of the external signal input from the rear-panel **[EXT MOD IN]** connector of the instrument will be blocked and the AC components can pass through the connector. The external modulation input port is similar to a high-pass filter whose low limit of the cutoff frequency is less than 5 Hz.
- **DC:** When "DC" is selected, all the AC components and DC components of the external input signal can pass through the connector.

Input Impedance

When the external modulation source is selected, click or tap **Setting** > **Impedance** to select "50Ω", "600Ω", or "HighZ" for setting the impedance of the **[EXT MOD IN]** connector.



NOTE

- When you select the internal modulation source, **Coupling** and **Impedance** are grayed out and disabled.
- When you select the external modulation source, **Waveform** is grayed out and disabled.

9.4 Pulse Modulation

During pulse modulation, the RF carrier waveform is modulated by the pulse signal. This function is required to install the option DSG5000-PUL.

9.4.1 To Enable the Pulse Modulation

Click or tap **Pulse** > **Switch** to select "ON" or "OFF".

- **ON:** enables the pulse modulation function.
- **OFF:** disables the pulse modulation function. This is the default state.

9.4.2 To Select Modulation Source

Click or tap **Pulse** > **Source** to select "Int" or "Ext" as the modulation source.

- **Internal**

When you select "Int", the internal modulation source is enabled. At this point, the modulation signal is generated by the internal pulse generator. You can set the pulse mode, pulse period, pulse width, and other related parameters of the modulating signal.

- **External**

When you select "Ext", the **Mode**, **Setting**, and **Trigger** menus are disabled and grayed out. The signal generator receives the external pulse signal input from the front-panel **[PULSE]** connector as the modulating signal.

9.4.3 To Set the Pulse Type

After selecting the "Int" modulation source, click or tap **Mode** to select "Single" or "Train".

- **Single:** only one pulse signal is generated for one pulse period. This is the default pulse mode.
- **Train:** multiple pulse signals are generated for one pulse period. If you select "Train" mode, you can load the user-defined pulse list.



NOTE

If you select "Train" mode and want to load the pulse list, you need to install the option DSG5000-PUG.

9.4.4 To Set Other Pulse-related Parameters

Click or tap **Pulse** > **Setting** to set the pulse period, pulse width, pulse polarity, and pulse on/off status.

Pulse Period

The pulse period indicates the time the pulse signal needs to complete one cycle.

When you select "Single" pulse mode, click or tap **Setting** > **Period** to set the pulse period of the modulating signal.

- Input the period value with the pop-up numeric keypad, and select the desired unit.
- The range of the pulse period is from 40 ns to 170 s.
- The pulse period determines the repetition frequency of the internal pulse modulating signal.

Pulse Width

Indicates the pulse duration of the generated pulse signal.

When you select "Single" pulse mode, click or tap **Setting** > **Width** to set the pulse width of the modulating signal.

- Input the width value with the pop-up numeric keypad.
- The range of the pulse width is from 10 ns to (170 s - 10 ns).
- The pulse width is limited by the minimum pulse width and pulse period.

pulse width \geq minimum pulse width;

pulse width \leq pulse period - 10 ns



NOTE

Period and **Width** menu are disabled and grayed out when the external modulation source is selected or when Train pulse mode is selected.

Pulse Polarity

Click or tap **Setting** > **Polarity** to select "Normal" or "Inverted" as the polarity of the current pulse modulating signal. By default, it is "Normal".

Pulse Output

Click or tap **Setting** > **Pulse Out** to select "ON" or "OFF".

- **ON:** enables the pulse output function. At this point, the microwave signal generator can output the pulse signal generated by the internal pulse generator via the front-panel **[PULSE]** connector. The output signal is related to the **Mode** setting.
- **OFF:** disables the pulse output function. This is the default state.

Load the Pulse List

After selecting "Train" pulse mode, click or tap **Setting** > **Load**. Select the pulse list (the file suffixed with "*.csv") to be loaded from the disk, then click or tap **Load** at the right side of the interface. The instrument will load the pulse list data.

The format of the pulse list file to be loaded is shown below.

SN ^[1]	On Time ^[2]	Off Time ^[3]	Repetition ^[4]	Dwell Time ^[5]
1	4.00 ms	5.00 ms	2	18.00 ms

SN ^[1]	On Time ^[2]	Off Time ^[3]	Repetition ^[4]	Dwell Time ^[5]
2	2.00 ms	4.00 ms	5	30.00 ms
3	15.55 ms	100.50 us	2	31.30 ms



NOTE

- [1]: Indicates the line number for the pulse list.
- [2]: Indicates the pulse on time. The duration of high level for the set pulse.
- [3]: Indicates the pulse off time. The duration of low level for the set pulse.
- [4]: Indicates the number of repetitions of an "On/Off-Time" value pair.
- [5]: Indicates the duration of the pulse to be set currently.

The following diagram takes the data value of Line 1 for the pulse list as an example to depict the parameter specified in the pulse list.

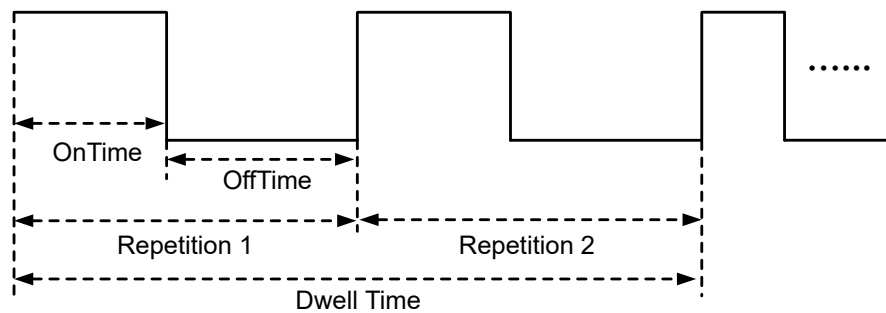

TIP

You need to use the Excel to generate the file suffixed with "*.csv". Then open the file, and edit the parameters directly in the Excel file. Save it to the USB storage device. You can store the file to the instrument via USB or FTP, and load the file to the instrument when needed.

View the Pulse List

After selecting "Train" pulse mode, click or tap **Setting** > **View** to view the loaded pulse list of the instrument. When no files are loaded, it shows the default pulse list of the instrument. When no files are loaded, it shows the default pulse list of the instrument.



NOTE

You can also use the HDMI-connected external display or the SCPI Pulse edit the pulse list, perform loading, saving, insertion, deletion operation.

9.4.5 Trigger

When you select "Int" modulation source, click or tap **Trigger** > **Trig Mode** to select "Auto", "Ext", "Gate", "Key", or "Bus".

- **Auto Trigger**

By default, the trigger type is "Auto". The microwave signal generator meets the trigger condition at any time and will start the pulse modulation once the Pulse function is enabled.

- **External Trigger**

After selecting "Ext" trigger, the RF signal generator receives the trigger signal input from the front-panel [TRIGGER] connector. The instrument starts a pulse modulation each time a TTL pulse with the specified polarity is received.

- Trig Slope

To specify the polarity of the TTL pulse, click or tap **Trig Slope** to select "Pos" or "Neg". By default, it is "Pos".

- Trigger Delay

When you select "Int" modulation source and "Ext" Trig mode, click or tap **Trig Delay** to set the delay from the start of receiving the external trigger signal to the start of the pulse modulating signal (as shown in *Figure 9.2*). Then the numeric keypad is displayed. Input the delay value and select the desired unit. The range of the delay time is from 10 ns to 170 s.

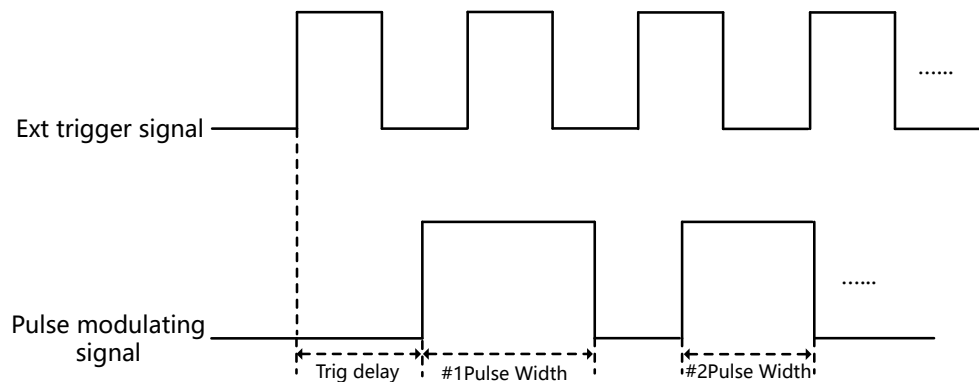
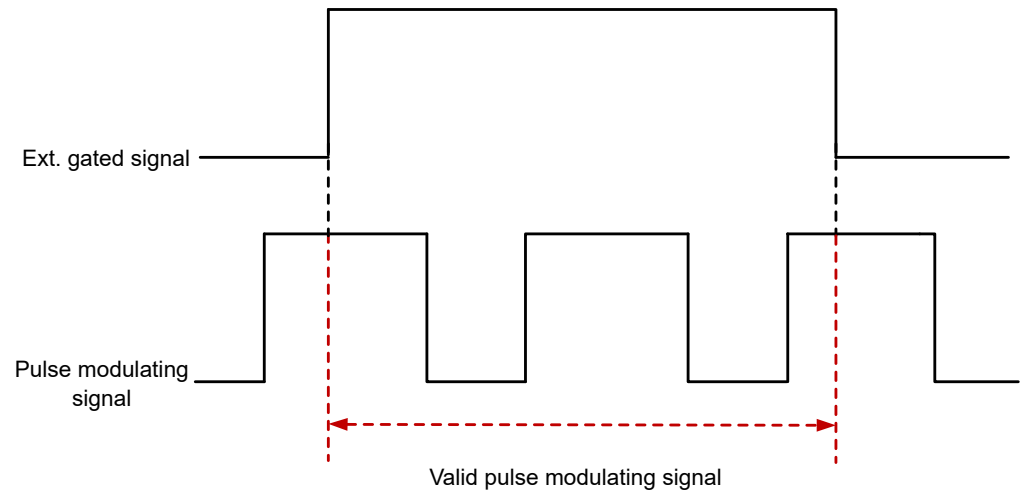

Figure 9.2 Trigger Delay

- **Gated Trigger**

After selecting "Gated" trigger, the RF signal generator receives the external gated signal input from the front-panel [TRIGGER] connector. The instrument starts a pulse modulation within its valid level each time a gated signal with the specified polarity is received, as shown in the figure below.



To specify the polarity of the external gated signal, click or tap **Gate Polar** to select "Normal" or "Inverted". By default, it is "Inverted".



- **Key Trigger**

After selecting the Key trigger, the instrument starts a pulse modulation each time you click or tap **Key**.

- **Bus Trigger**

After selecting the Bus trigger, the instrument starts a pulse modulation each time you send the "*TRG" command.

10 System Utility Setting

Click or tap  to enter the system utility setting interface, as shown in *Figure 10.1*. The upper part of the interface shows the system-related information, and lower part of the interface shows the menus related to system utility setting. The channel information is not available to see in this interface. To go back to the main interface, tap  again or click/tap .

The system utility setting interface, by default, displays the IP Address, Gateway, IP Status and other system-related information. You can click or tap the menus at the lower part of the interface to make other system configurations.

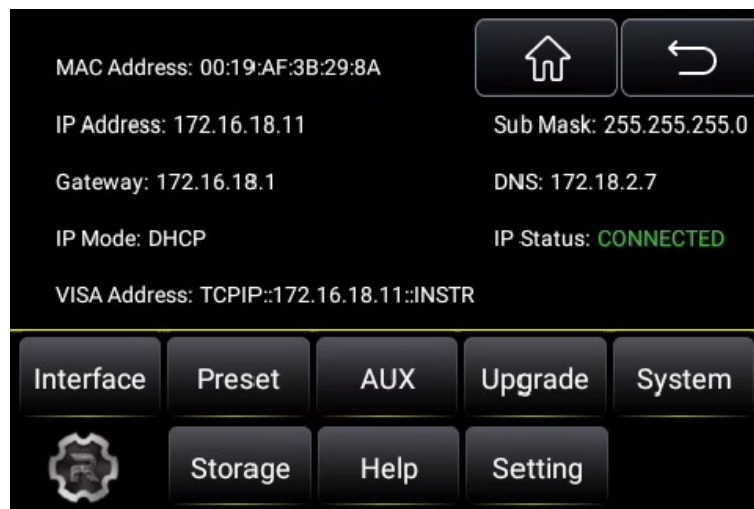



Figure 10.1 System Utility Setting

10.1 Interface Setting

The instrument supports the LAN interface.

Click or tap  > **Interface** to set the LAN parameters.

10.1.1 LAN

Click or tap **Interface** > **LAN** to set the LAN parameters.

IP Configuration Type

Three types of IP modes are available: DHCP, Auto IP, and Manual IP.

- **DHCP**

When you click or tap to select DHCP, the DHCP server assigns network parameters (such as the IP address, subnet mask, and gateway) to the instrument based on the current network configuration.

- **Auto IP**

When you click or tap to select "Auto-IP", the instrument will acquire the IP address ranging from "169.254.0.1" to "169.254.255.254" and the subnet mask (255.255.0.0) automatically based on the current network configuration.

- **Manual-IP**

When you click or tap to select "Manual-IP" and unselect "DHCP" and "Auto-IP", you can self-define a desired IP address for the instrument. The IP Address, Gateway, Sub Mask, and DNS are in editing state. You can click or tap the input field of these parameters to set them with the pop-up numeric keypad.

- **IP Address:** The format of the IP address is "nnn.nnn.nnn.nnn". The range for the first segment (nnn) of the address is from 1 to 223 (except 127); and the range for the other three segments is from 0 to 255. You are recommended to ask your network administrator for an IP address available.
- **Sub Mask:** The format of the subnet mask is nnn.nnn.nnn.nnn. Wherein, the range of "nnn" is from 0 to 255. You are recommended to ask your network administrator for a subnet mask available.
- **Gateway:** The format of the default gateway is "nnn.nnn.nnn.nnn". The range for the first segment (nnn) of the address is from 1 to 223 (except 127); and the range for the other three segments from 0 to 255. You are recommended to ask your network administrator for a gate address available.
- **DNS:** The format of the DNS address is "nnn.nnn.nnn.nnn". The range for the first segment (nnn) of the address is from 1 to 223 (except 127); and the range for the other three segments is from 0 to 255. You are recommended to ask your network administrator for an address available.

NOTE



The instrument attempts to acquire the IP address configuration according to the sequence of DHCP, Auto IP, and Manual IP. These three modes cannot be disabled at the same time.

mDNS

Enables or disables the mDNS port. When enabled, it allows to broadcast the network service to the outside, enabling communication with the devices of the same network segment.

Host Name

Click or tap the input field of Host Name to set the host name with the pop-up numeric keypad.

Reset

Turns on DHCP and Auto-IP; turns Manual-IP off. Clears the set network password and restores it to the factory defaults.

Apply

After the LAN interface configuration is finished, click or tap **Apply** to apply the configuration.

10.2 Preset

Click or tap  > **Preset** to set the "Preset Type".

Click or tap to select "Factory" or "User".

- When "Factory" is selected, the instrument loads the default factory settings.
- When "User" is selected, click or tap **Save Preset** to save the current system setting as user-defined settings to the internal non-volatile memory.

After performing the preset settings, click or tap  to go to the main interface. At this point, when you click or tap the **Preset** menu in the main interface, it will load the preset settings that you have set for the whole system.

10.3 AUX

Click or tap  > **AUX** to set the auxiliary interfaces of the instrument.

10.3.1 4.8 GHz Signal Input/Output

Click or tap **AUX** > **Input/Output** to set the input and output of the 4.8 GHz carrier frequency reference signal.

- **4.8 IN**
 - Internal: the internal 4.8 GHz signal.
 - External: the external signal input from the rear-panel **[4.8 GHz IN]** connector.
- **4.8 OUT**

Click or tap ON/OFF to enable/disable the output of the 4.8 GHz carrier frequency reference signal. When ON, the signal is output via the rear-panel **[4.8 GHz OUT]** connector.

10.4 Upgrade

Click or tap  > **Upgrade**, then select "Local Upgrade" or "Online Upgrade" to perform system upgrade.



CAUTION

When upgrading the system, please follow the instructions below:

1. Download the specified upgrade package file under the directory of this product from RIGOL official website.
2. Read carefully the installation instructions and version information from the upgrade package file to check whether the package file matches your instrument model.
3. During upgrade, ensure that your instrument is connected to power source properly and works normally. Do not disconnect the instrument from power source during its upgrade.
4. During upgrade, never perform any operation on the instrument.
5. During upgrade, never perform remote control over the instrument.
6. If any exceptions occur during upgrade, please power off the instrument and restart it again, then perform the upgrade operation again.

10.4.1 Local Upgrade

Before performing the local upgrade, save the upgrade file to the USB storage device or put the upgrade file to the local disk (Disk C) via FTP.

- **FTP**

When the instrument is in LAN connection, use the FTP method to access the upgrade file. For example, the IP address of the instrument is 192.68.0.1. Input the address (ftp://192.68.0.1/) of the file resource manager of the PC to access the file resource manager of the instrument. Copy the upgrade file to the manager. After uploading the upgrade file, you can view the file in *Disk Management*.

- **USB**

Copy the upgrade file to the USB storage device (FAT32). Insert the USB storage device into the instrument. Select the upgrade file and perform the upgrade operation.

Click or tap **Upgrade** > **Local Upgrade** to enter the file resource management system, as shown in *Figure 10.2*. Select the disk where the file resides and find the file. Then click or tap **Upgrade** to start the system upgrade process.

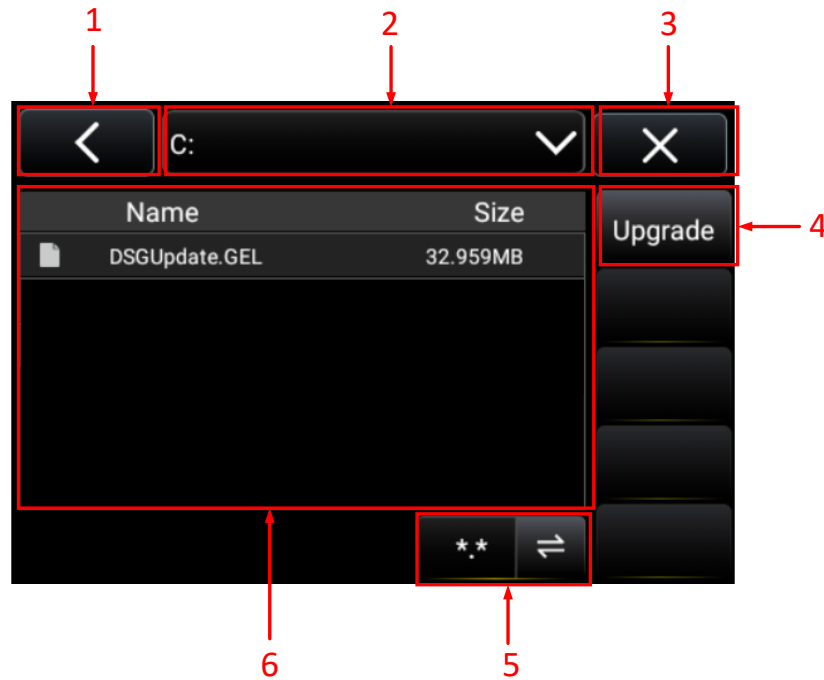

Figure 10.2 File Resource Management System

1. Go Back to the Previous Directory

2. Disk Selection Area

Displays the current file path. Click to tap the drop-down button to select the local disk or the external USB disk.

3. Close Icon

Click or tap the close icon to close the current interface. It will go to the previous interface.

4. Upgrade

Selects the upgrade file, then click or tap Upgrade. The instrument starts to upgrade.

5. File Type Selection

Selects the type of file to be displayed.

6. Disk File

Displays the file information of the current directory. You can select the desired file or folder.

- For folder operation, click or tap the folder to open it and select the file in it. To select the folder, long click or tap it.
- For file operation, click/tap it directly to select the single file. You can also long click or tap it to select it.

10.4.2 Online Upgrade

After the instrument is connected to the network via the LAN interface, click or tap **Upgrade > Online Upgrade**. Then the "RIGOL product online upgrade service terms" is displayed. Click or tap **Accept** to start upgrade. During upgrade, LAN will be disconnected and the instrument will be restarted automatically.

10.5 System

Click or tap  > **System** to view the system information, option information, and system message.

System Information

Click or tap **System** to view the model, serial number, version number, and other system-related information. Click or tap **LICENSE** to view the open source acknowledgment for the instrument.

Option Information

Click or tap **Option** to view the option list and the option installation status of the DSG5000 series.

Install the option

The license is a fixed length of strings. Each instrument has a unique license. The license file has a specific file format and the filename is suffixed with ".lic". After you purchase the desired option, you will get the key to the option license. You can use the key to generate the option license by taking the following steps:

1. Obtain an option license

- a. Log in to the **RIGOL** official website (<http://www.rigol.com>). Click **SERVICE CENTRE > License Activation** to enter license code interface.

- b. In the interface, enter the correct key, serial number, and verification code. Then click **Generate** to obtain the download link of the option license file. If you need to use the option license file, click to download the file to the specified directory of the USB storage device.

2. Install the option

- a. Build communication between the microwave signal generator and the PC via the USB or LAN interface. Use the SCPI command :SYSTem:LKEY <option>@<license_key> to install the option.
- b. For example, :SYSTem:LKEY DSG5000-AMD@fbcd61febe039cfa3330036b8fe9fc885a2210b4a31f62. The microwave signal generator identifies the license received and matches the corresponding option. At this point, the corresponding option is installed and activated.

System Message

Click or tap **System Message** to view the list of the latest messages, including the message ID, content, and the time of each message.

10.6 Storage

Click or tap  > **Storage** to save and load files, as well as perform disk management.

10.6.1 Storage

1. File Type

The available file types include Status, Flatness, Sweep, Pulse, and Image.

2. Channel

The available storage channels include All, CH1, CH2, CH3, CH4, CH5, CH6, CH7, and CH8.

3. File Prefix

Click or tap the input field of the file prefix to edit the prefix with the numeric keypad. Click or tap ON or OFF to enable or disable the use of the edited file prefix. When you select ON, the edited prefix will be added into the filename input field automatically when you save a file.

4. Format, Invert, Header, Color

When you select "Image" under File Type, you can set the parameters such as the image format, invert, header, and color. You can also use the default settings.

5. Save

Click or tap **Save**, then select the disk or directory path for storage. Input the filename. Click or tap **Save** to save the file with the specified filename and file type to the currently selected directory.

**TIP**

The filename can contain at most 28 English characters or numbers (or 14 Chinese characters).

6. Load

Click or tap **Load**. Select the disk and then select the file to be loaded from the disk. Click or tap **Load** to load the file to the system.

10.6.2 Disk Management

Click or tap **Storage** > **Disk Info** to view the disk information and perform disk management.

- **Disk Info**

Displays the disk type, file system, used space, total space, and etc.

- **Disk**

Click or tap **Disk** to view and select the disk in the instrument. By default, Disk C is selected.

- **Disk Management**

After you select a disk, click or tap **Disk** to perform a series of disk management operations.

- New Folder

Creates a folder. The folder name can contain at most 28 English characters or numbers (or 14 Chinese characters).

- Rename

Renames a file that has been stored.

- Delete

Deletes a file that has been stored.

- Copy

Click or tap one file that has been stored; or long press to select one folder. Then click or tap **Copy** to copy the currently selected file or folder under the specified disk.

- Paste

Pastes the file or folder to the current path.

- **Format**

Formats the local disk.

10.7 Help Menu

Click or tap  > **Help** to enter the Help documentation. You can get its help information by clicking on the link for the introduction of the specified function.

10.8 Setting

Click or tap  > **Setting** to set system-related parameters and perform self-check for the LCD screen and the touch-enabled gestures.

10.8.1 Basic Settings

Click or tap **Basic settings** to set the language, power status, time switch, screen status, and etc.

- **Language**

DSG5000 supports two languages: Chinese and English. Click or tap to select the desired language type.

- **Power Status**

Click or tap to select "Default" or "Open".

- When "Default" is selected, once the instrument is connected to power source, you need to press down the front-panel power button after turning on the rear-panel power switch.
- When "Open" is selected, once the instrument is connected to power source, the instrument starts automatically after the rear-panel power switch is turned on.

- **Time Switch**

Enables or disables the display of the system date and time.

- **Date&Time**

Sets the system date and time of the instrument. Click or tap the input field of year, month, day, hour, and minute to input the date and time.

- **Screen Lock**

Locks or unlocks the touch screen.

- **ON:** locks the touch screen. The touch screen operation is disabled. At this time, the screen stops updating and is locked. The measurement speed is improved. Screen locking is mainly used in remote operation mode.
- **OFF:** unlocks the touch screen. The touch screen operation is enabled. This is the default state.

- **Safe Clear**

Clears all data you set and restore it to the factory defaults.

Click or tap **Safe Clear**, and a prompt message confirming whether to clear it safely is displayed. Click **OK** to clear all the data stored in the internal disk. Click or tap **Cancel** to cancel safe clear operation.

10.8.2 Self Check

Click or tap **Self Check** to perform the LCD test and touch test.

LCD Test

Click or tap **LCD Test** to enter the LCD test interface. The system provides 15 colors for screen test to check whether the screen has a dot defect. Click or tap any place to switch the screen color and exit the test.

Touch Test

Click or tap **Touch Test** to enter the touch test.

First enter the touch screen test interface, as shown in the figure below. Slide with your finger on the screen. If there is a line displaying at the empty area where you slide on the screen and the box that you tap turns out to be filled with green background, it indicates that the touch function of this area is normal.

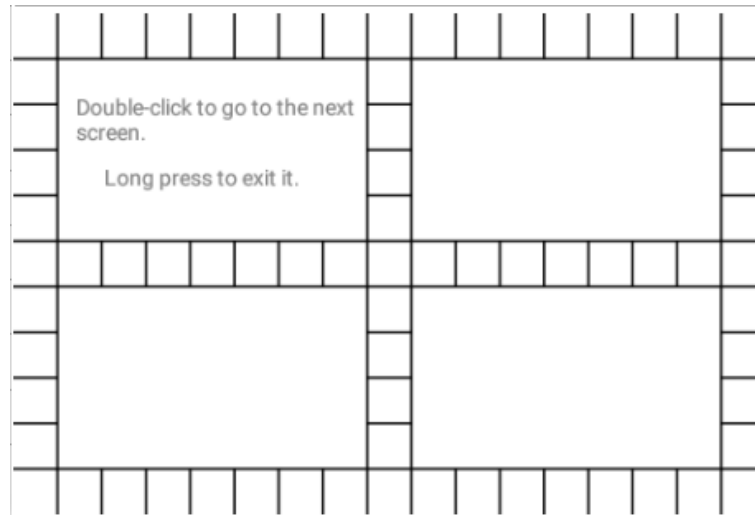

Double-click the current test screen or tap the screen twice to go to the next test screen. Also when all the boxes have turned green, it will go to the next test screen automatically, as shown in the figure below. At this time, you can pinch or stretch the icon on the screen to zoom out or zoom in the icon on RIGOL to zoom out or zoom in icons to check whether the gesture works normally. Long press the screen to exit the test interface.



11 Remote Control

The device can be connected to the PC via the USB or LAN to set up communication and realize remote control through the PC. Three ways of remote control are supported: user-defined programming, PC software, and Web Control.

- **User-defined Programming**

Users can program and control the instrument by using the SCPI (Standard Commands for Programmable Instruments) commands. For details about the SCPI commands and programming, refer to *Programming Guide*.

- **PC Software**

Users can use the PC software to send commands to control the instrument remotely. RIGOL Ultra Sigma is recommended. You can download the software from RIGOL official website (<http://www.rigol.com>).

Operation Procedures:

- Set up communication between the instrument and PC.
- Run Ultra Sigma and search for the instrument resource.
- Open the remote command control panel to send commands.

- **Web Control**

This instrument supports Web Control. Connect the instrument to the network, then input the IP address of the instrument into the address bar of the browser of your computer. The web control interface is displayed. Click Web Control to enter the web control page. Then you can view the display of the real-time interface of the instrument. However, if an external display is connected via the HDMI interface, you can see the HDMI interface on the web control interface. When disconnected from the HDMI interface, it will show the user interface of the instrument again. Through the Web Control, you can migrate the device control to the control terminals (e.g. PC, mobile phone, iPad, and other smart terminals) to realize remote control of the instrument. When you first log in to the Web Control, use the user name "admin" and the password "rigol".

This chapter will illustrate how to use the RIGOL Ultra Sigma software to remotely control the instrument via various interfaces.

CAUTION

Before setting up communication, please turn off the instrument to avoid causing damage to the communication interfaces.



11.1 Remote Control via USB

1. Connect the device

Use the USB cable to connect the rear-panel **[USB DEVICE]** of the instrument to the USB HOST interface of the PC.

2. Search for the device resource

Start up Ultra Sigma and the software will automatically search for the resource currently connected to the PC via the USB interface. You can also click **USB-TMC** to search for the resource.

3. View the device resource

The resources found will appear under the "RIGOL Online Resource" directory, and the model number and USB interface information of the instrument will also be displayed.

4. Control the instrument remotely

Right-click the device resource name and select "SCPI Panel Control" to open the remote command control panel. Then you can send commands and read data through the panel. For details about the SCPI commands and programming, refer to *Programming Guide*.

11.2 Remote Control via LAN

1. Connect the device

Use the network cable to connect the instrument to your local area network (LAN).

2. Configure network parameters

Configure the network parameters of the instrument according to "**LAN**".

3. Search for search device resource

Start up Ultra Sigma and click **LAN** to open the panel as shown in the figure below. Click **Search** and the software searches for the instrument resources currently connected and the resources found are displayed at the right section of the window as shown in the figure below. Click **OK** to add it.

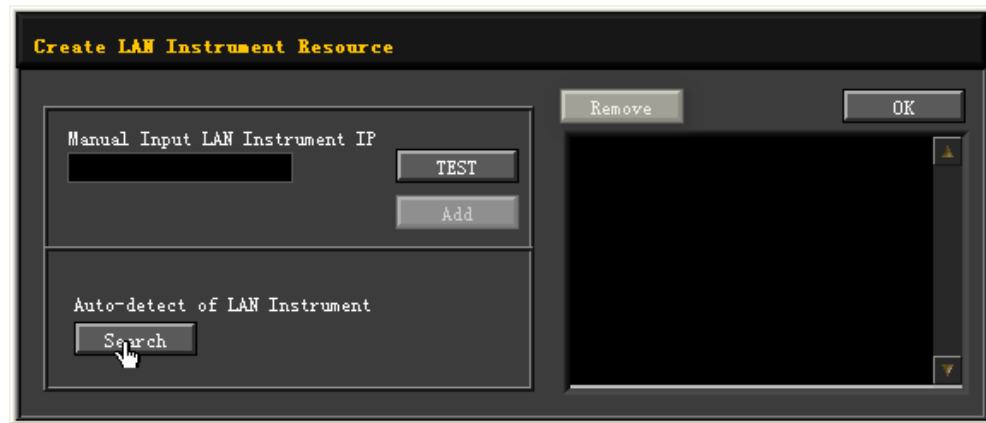

Besides, you can input the IP address of the instrument manually into the text field under "Manual Input LAN Instrument IP", then click **TEST**. If the instrument passes the test, click **ADD** to add the instrument to the LAN instrument resource list in the right section; if the instrument fails the test, please check whether the IP address that you input is correct, or auto search the IP address of the instrument and add it to the instrument resource.



TIP

The IP address of the selected resource should be consistent with that of the LAN interface.

4. View the device resource

The resources found will appear under the "RIGOL Online Resource" directory.

5. Control the instrument remotely

Right-click the device resource name and select "SCPI Panel Control" to open the remote command control panel. Then you can send commands and read data through the panel.

6. Load LXI webpage

As this instrument conforms to LXI CORE 2011 DEVICE standards, you can load LXI webpage through Ultra Sigma (right-click the instrument resource name and select "LXI-Web"). Various important information about the instrument (including the model, manufacturer, serial number, description, MAC address, and IP address) will be displayed on the webpage. You can also directly input the IP address of the oscilloscope in the address bar of the PC browser to load the LXI webpage.



12 Application Examples

This chapter introduces the basic operations of the instrument as well as a few specific examples so that the user can quickly master how to operate the signal generator.

12.1 To Output the RF Signal

Output the RF signal with 5 GHz frequency and -10 dBm amplitude from the [RF 50Ω] connector of CH2.

1. Restore to factory setting

Click or tap  > **Preset**. Select the preset type to "Factory". Then click or tap  to go to the main interface. Click or tap **Preset** to restore the instrument to factory defaults. By default, the frequency offset is 0 Hz to and the amplitude offset is 0 dB.



2. Select the channel

Click or tap to select CH2. The main interface shows that CH2 is currently selected.

3. Set the frequency

Click or tap **Freq** > **Freq**. Input the frequency value 5 with the pop-up numeric keypad, and select the unit "GHz".

- The frequency units available are GHz, MHz, kHz, and Hz.
- You can also directly click or tap **Enter** to confirm the default unit for the frequency.
- You can click or tap the input field of the Freq parameter to modify the value.

After completing the frequency setting, click or tap  or  to go to the main interface.

4. Set the amplitude

Click or tap **Level** > **Level**. Input the amplitude value -10 with the pop-up numeric keypad and select the unit "dBm". You can also directly click or tap **Enter** to confirm the default unit dBm.

- The amplitude units available are dBm, V, mV, and uV.
- You can click or tap the input field of the Level parameter to modify the value.



5. Enable the RF output

Long click or tap channel display area of CH2 to enable the RF output of CH2. At this time, the [RF 50Ω] connector of CH2 outputs the RF signal based on the current setting. You can also click or tap **RF** to select "ON" to enable the RF output for all the channels.

12.2 To Output the RF Sweep Signal

Configure a continuous linear step sweep to output the RF sweep signal from the [RF 50Ω] connector of CH1 to make its frequency stay within a range from 1 GHz to 2 GHz, amplitude from -20 dBm to 0 dBm, the number of sweep points 10, and the dwell time 500 ms.

1. Restore to factory setting

Click or tap  > **Preset**. Select the preset type to "Factory". Then click or tap  to go to the main interface. Click or tap **Preset** to restore the instrument to factory defaults. By default, the frequency offset is 0 Hz and the amplitude offset is 0 dB.

2. Select the channel

Click or tap to select CH1. The main interface shows that CH1 is currently selected.

3. Set the step sweep parameters

Click or tap **Sweep** > **Type** to select "Step".

Click or tap **Setting** > **Freq/Level** to set the frequency and level parameters.

- Start Freq

Click or tap **Start Freq**, then input the start frequency 1 with the pop-up numeric keypad and select the unit "GHz".

- Stop Freq

Click or tap **Stop Freq**, then input the stop frequency 2 with the pop-up numeric keypad and select the unit "GHz".

- Start Level

Click or tap **Start Level**, then input the start level -20 with the pop-up numeric keypad and select the unit "dBm".

- Stop Level

Click or tap **Stop Level**, then input the stop level 0 with the pop-up numeric keypad and select the unit "dBm".

Click or tap  > **Points**, then input the number of sweep points 10 with the pop-up numeric keypad. Click or tap **Enter** to confirm the input.

Click or tap **Dwell Time**, input the value of the dwell time 500 with the pop-up numeric keypad, and then select the unit "ms".

4. Enable RF sweep

Click or tap **Sweep** > **Sweep** to select "Freq & Level" to enable both the frequency sweep and the amplitude sweep.



5. Enable the RF output

Long click or tap channel display area of CH1 to enable the RF output of CH1. At this time, the **[RF 50Ω]** connector of CH1 outputs the RF sweep signal based on the current setting. You can also click or tap **RF** to select "ON" to enable the RF output for all the channels.

12.3 To Output the RF Modulated Signal

Output an AM modulated signal with 800 MHz frequency and -20 dBm amplitude from the **[RF 50Ω]** connector of CH2. Set the AM modulation depth to 60% and the modulation frequency to 20 kHz.

1. Restore to factory setting

Click or tap  > **Preset**. Select the preset type to "Factory". Then click or tap  to go to the main interface. Click or tap **Preset** to restore the instrument to factory defaults. By default, the modulation source is Internal and the modulating waveform is Sine.

2. Select the channel

Click or tap to select CH2. The main interface shows that CH2 is currently selected..

3. Set the carrier frequency and amplitude

a. Carrier frequency

Click or tap **Freq** > **Freq**. Input the frequency value 800 with the pop-up numeric keypad, and select the unit "MHz".

b. Carrier amplitude

Click or tap **Level** > **Level**. Input the amplitude value -20 with the pop-up numeric keypad and select the unit "dBm". You can also directly click or tap **Enter** to confirm the default unit dBm.

4. Set the AM modulation parameters

- a. Click or tap **Mod** > **AM** to enter the AM setting interface.
- b. Click or tap **Depth**. Then input the AM depth value 60 with the pop-up numeric keypad and select the unit "%". You can also directly click or tap **Enter** to confirm the default unit %.
- c. Click or tap **Freq**. Input the modulation frequency value 20 with the pop-up numeric keypad, and select the unit "kHz".
- d. Click or tap **Switch** to select "ON" to enable the AM function.

5. Enable the RF modulation output

Click or tap **MOD** in the main interface to enable the modulation output. Then long click or tap the channel display area of CH2 to enable the RF output of CH2. At this time, the **[RF 50Ω]** connector of CH2 outputs the AM modulated signal based on the current setting.

TIP

Click or tap **MOD** in the interface to select "ON" to enable the modulation output for all the channels. If you only want to enable the modulation output of CH2, connect an external display via the HDMI interface. Then send the specified SCPI command to enable the modulation output of CH2 or operate on the externally connected display.



13 Troubleshooting

This chapter lists the encountered failures of the instrument and their solutions. If the following problems occur, locate and resolve the problems according to the following steps. If the problems still persist, contact RIGOL and provide your instrument

information to us. For instrument information, press  > **System** to obtain the instrument information.

When I power on the instrument, the instrument stays black and does not display anything.

1. Check whether the fan works normally.
 - If the fan works normally, but the screen stays black, check whether the connecting cable that connects the screen is loose.
 - If the fan does not work normally, it indicates that the instrument has failed to start up. Please handle it according to the method specified in Step 2.
2. Check whether the power supply has been connected correctly and the power switch has been turned on.
3. Check whether the fuse is burned. If you need to replace the fuse, please use the specified fuse (AC 250 V, T3.15 A).
4. Restart the instrument after finishing the above inspections.
5. If the problem still persists, please contact RIGOL.

The settings are correct, but the waveform is not generated properly.

There is no RF output.

1. Check whether the signal connecting cable is tightly connected to the corresponding **[RF 50Ω]** connector.
2. Check whether the connecting cable has internal damage.
3. Check whether the connecting cable is tightly connected to the test instrument.
4. Check whether corresponding RF channel is enabled and the color of the user interface display area is the same as that of the channel.

5. Check whether the output amplitude of the RF signal is too small. If yes, adjust the output amplitude properly.

The RF output is not modulated.

1. Check whether the signal connecting cable is tightly connected to the corresponding [RF 50Ω] connector.
2. Check whether the connecting cable has internal damage.
3. Check whether the connecting cable is tightly connected to the test instrument.
4. Check whether MOD and RF are both enabled.
5. Check whether the modulation parameter setting is correct and adjust the parameter appropriately.
6. If external modulation source is used, make sure that the external source is correctly connected and outputs signal. At the same time, the external source should work within the specified range of the instrument.

In list or step sweep, the level does not change.

1. Make sure that the sweep function is set to "Level" or "Freq & Level".
2. If the current sweep function is set to "Freq", the level value will not be changed.

The USB storage device cannot be recognized.

1. Check whether the USB storage device can work normally when connected to other instruments or PC.
2. Make sure that the USB storage device used is a Flash type. This instrument does not support hardware USB storage device.
3. After restarting the instrument, insert the USB storage device again to check whether it works normally.
4. If the USB storage device still cannot work normally, please contact RIGOL.

The performance specifications test is failed.

1. Check whether the instrument is within the calibration period.

2. Check whether the instrument has been warmed up for at least 40 minutes before the test.
3. Check whether the instrument is under the specified temperature.
4. Check whether the test is under strong-magnetism environment.
5. Check whether the power supplies of the instrument and the test system have a strong interference.
6. Check whether the performance of the test device used meets the requirement.
7. Make sure that the test device used is within the calibration period.
8. Check whether the test devices used meets the required conditions of the manual.
9. Check whether all the connections are tight.
10. Check whether any cable has internal damage.
11. Make sure that the operations conform to settings and processes specified in the performance verification manual.
12. Check whether the error calculation has faults.
13. Correctly understand the definitions of "Typical", and "Nominal" values for this product.

Typical (typ.): typical performance, which 80 percent of the measurement results will meet at room temperature (approximately 25°C). The data are not warranted and do not include the measurement uncertainty.

Nominal (nom.): the expected mean or average performance or a designed attribute (such as the 50Ω connector). The data are not warranted and are measured at room temperature (approximately 25°C).

14 Appendix

14.1 Appendix A: Accessories and Option List

	Description	Order No.
Model	2-CH Microwave Signal Generator, 9 kHz to 20 GHz	DSG5202
	4-CH Microwave Signal Generator, 9 kHz to 20 GHz	DSG5204
	6-CH Microwave Signal Generator, 9 kHz to 20 GHz	DSG5206
	8-CH Microwave Signal Generator, 9 kHz to 20 GHz	DSG5208
	2-CH Microwave Signal Generator, 9 kHz to 12 GHz	DSG5122
	4-CH Microwave Signal Generator, 9 kHz to 12 GHz	DSG5124
	6-CH Microwave Signal Generator, 9 kHz to 12 GHz	DSG5126
	8-CH Microwave Signal Generator, 9 kHz to 12 GHz	DSG5128
Standard Accessory	Power Cord Conforming to the Standard of the Destination Country	-
Options	Pulse Modulation	DSG5000-PUL
	Pulse Train Generator	DSG5000-PUG
	Analog Modulation	DSG5000-AMD
	High Stability Clock (OCXO)	OCXO-D08
	Rack Mount Kit	RM2031

**NOTE**

For all the mainframes, accessories, and options, please contact the local office of **RIGOL**.

14.2 Appendix B: Warranty

RIGOL TECHNOLOGIES CO., LTD. (hereinafter referred to as RIGOL) warrants that the product mainframe and product accessories will be free from defects in materials and workmanship within the warranty period. If a product proves defective within the warranty period, RIGOL guarantees free replacement or repair for the defective product.

To get repair service, please contact your nearest RIGOL sales or service office.

There is no other warranty, expressed or implied, except such as is expressly set forth herein or other applicable warranty card. There is no implied warranty of merchantability or fitness for a particular purpose. Under no circumstances shall RIGOL be liable for any consequential, indirect, ensuing, or special damages for any breach of warranty in any case.

Boost Smart World and Technology Innovation

Industrial Intelligent
Manufacturing



Semiconductors

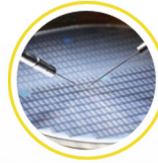

Education &
Research

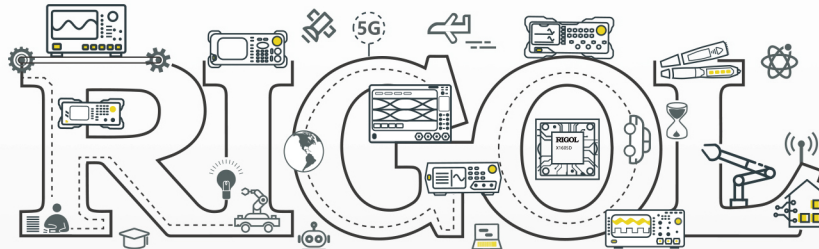

Communication

System Integration

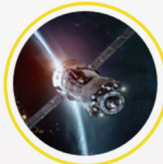

New Energy



- 5G Cellular-5G/WIFI
- UWB/RFID/ ZIGBEE
- Digital Bus/Ethernet
- Optical Communication

- Digital/Analog/RF Chip
- Memory and MCU Chip
- Third-Generation Semiconductor
- Solar Photovoltaic Cells

- New Energy Automobile
- PV/Inverter
- Power Test
- Automotive Electronics

*Provide Testing and Measuring Products
and Solutions for Industry Customers*

HEADQUARTER

RIGOL TECHNOLOGIES CO., LTD.
No.8 Keling Road, New District,
Suzhou, JiangSu, P.R.China
Tel: +86-400620002
Email: info@rigol.com

JAPAN

RIGOL JAPAN CO., LTD.
5F, 3-45-6, Minamiotsuka, Toshima-Ku,
Tokyo, 170-0005, Japan
Tel: +81-3-6262-8932
Fax: +81-3-6262-8933
Email: info.jp@rigol.com

EUROPE

RIGOL TECHNOLOGIES EU GmbH
Carl-Benz-Str.11
82205 Gilching
Germany
Tel: +49(0)8105-27292-0
Email: info-europe@rigol.com

KOREA

RIGOL KOREA CO., LTD.
5F, 222, Gonghang-daero,
Gangseo-gu, Seoul, Republic of Korea
Tel: +82-2-6953-4466
Fax: +82-2-6953-4422
Email: info.kr@rigol.com

NORTH AMERICA

RIGOL TECHNOLOGIES, USA INC.
10220 SW Nimbus Ave.
Suite K-7
Portland, OR 97223
Tel: +1-877-4-RIGOL-1
Fax: +1-877-4-RIGOL-1
Email: info@rigol.com

RIGOL® is the trademark of **RIGOL TECHNOLOGIES CO., LTD.** Product information in this document is subject to update without notice. For the latest information about **RIGOL's** products, applications and services, please contact local **RIGOL** channel partners or access **RIGOL** official website: www.rigol.com