

Multi-output DC Power Supply

GPE-3060/GPE-6030

USER MANUAL

GW INSTEK PART NO. 82GP360300301



ISO-9001 CERTIFIED MANUFACTURER

GW INSTEK

This manual contains proprietary information, which is protected by copyrights. All rights are reserved. No part of this manual may be photocopied, reproduced or translated to another language without prior written consent of Good Will company.

The information in this manual was correct at the time of printing. However, Good Will continues to improve products and reserves the rights to change specification, equipment, and maintenance procedures at any time without notice.

Good Will Instrument Co., Ltd.
No. 7-1, Jhongsing Rd., Tucheng Dist., New Taipei City 236, Taiwan

Table of Contents

SAFETY INSTRUCTIONS	5
OVERVIEW	8
Introduction	8
Series Lineup / Main Features	10
Principle of Operation	11
Front Panel Overview	12
Rear Panel Overview.....	17
CV/CC Crossover Characteristics.....	18
SETUP	19
Power Up	19
Load Cable Connection.....	20
Output On/Off	21
Select CH1/CH2 series or parallel mode	21
Setting Lock from Front Panel	23
Set the output state at startup	23
Selection voltage/current display digits.....	24
Remote Control Setting	25
OPERATION	26
CH1/CH2 Independent Mode.....	26
CH3 Independent Mode	28
CH1/CH2 Series Tracking Mode.....	30
CH1/CH2 Parallel Tracking Mode.....	34
FAQ	36
APPENDIX	37
Fuse Replacement	37
Specifications.....	38

Declaration of Conformity 40

INDEX **42**

S SAFETY INSTRUCTIONS

This chapter contains important safety instructions that you must follow when operating the GPE series and when keeping it in storage. Read the following before any operation to insure your safety and to keep the best condition.

Safety Symbols

These safety symbols may appear in this manual.



WARNING

Warning: Identifies conditions or practices that could result in injury or loss of life.



CAUTION

Caution: Identifies conditions or practices that could result in damage to the GPE series or to other properties.



DANGER High Voltage



Attention Refer to the Manual



Protective Conductor Terminal



Earth (ground) Terminal



Do not dispose electronic equipment as unsorted municipal waste. Please use a separate collection facility or contact the supplier from which this instrument was purchased.

Safety Guidelines

General Guidelines



CAUTION

- Do not place any heavy object on the device.
 - Avoid severe impacts or rough handling that leads to damaging the device.
 - Do not discharge static electricity to the device.
 - Do not block or obstruct the cooling fan vent opening.
 - Do not perform measurement at circuits directly connected to Mains (see note below).
 - Do not disassemble the device unless you are qualified as service personnel.
-

Power Supply



WARNING

- AC Input voltage:
100V/120V/220V/230VAC $\pm 10\%$, 50/60Hz
 - Connect the protective grounding conductor of the AC power cord to an earth ground, to avoid electrical shock.
-

Fuse



WARNING

- Fuse type:
100V/120V: T12A/250V
220V/230V: T6.3A/250V
 - Make sure the correct type of fuse is installed before power up.
 - To ensure fire protection, replace the fuse only with the specified type and rating.
 - Disconnect the power cord before fuse replacement.
 - Make sure the cause of fuse blowout is fixed before fuse replacement.
-

Cleaning the device

- Disconnect the power cord before cleaning.
 - Use a soft cloth dampened in a solution of mild detergent and water. Do not spray any liquid.
 - Do not use chemicals or cleaners containing harsh products such as benzene, toluene, xylene, and acetone.
-

- Operation Environment
- Location: Indoor, no direct sunlight, dust free, almost non-conductive pollution (note below)
 - Relative Humidity: < 80%
 - Altitude: < 2000m
 - Temperature: 0°C to 40°C

(Pollution Degree) EN 61010-1:2010 specifies the pollution degrees and their requirements as follows. The GPE series falls under degree 2.

Pollution refers to “addition of foreign matter, solid, liquid, or gaseous (ionized gases), that may produce a reduction of dielectric strength or surface resistivity”.

- Pollution degree 1: No pollution or only dry, non-conductive pollution occurs. The pollution has no influence.
- Pollution degree 2: Normally only non-conductive pollution occurs. Occasionally, however, a temporary conductivity caused by condensation must be expected.
- Pollution degree 3: Conductive pollution occurs, or dry, non-conductive pollution occurs which becomes conductive due to condensation which is expected. In such conditions, equipment is normally protected against exposure to direct sunlight, precipitation, and full wind pressure, but neither temperature nor humidity is controlled.

-
- Storage environment
- Location: Indoor
 - Relative Humidity: < 70%
 - Temperature: -10°C to 70°C

Disposal



Do not dispose this instrument as unsorted municipal waste. Please use a separate collection facility or contact the supplier from which this instrument was purchased. Please make sure discarded electrical waste is properly recycled to reduce environmental impact.

OVERVIEW

This chapter describes the GPE series in a nutshell, including its main features and front/rear panel introduction. After going through the overview, follow the Setup chapter (page 19) to properly power up and set operation environment.

Introduction

Overview

The GPE series regulated DC power supply series are adjustable, multifunctional work stations. It has three independent outputs: two with adjustable voltage/current levels and one with fixed level 5V. The series can be used for logic circuits where various output voltage or current are needed, and for tracking mode definition systems where plus and minus voltages with insignificant error are required.

Independent / Series Tracking / Parallel Tracking

The three output modes, independent, series tracking and parallel tracking can be selected through pressing the TRACKING key on the front panel. In the independent mode, the output voltage and current of each channel are controlled separately. In the tracking modes, both the CH1 and CH2 outputs are automatically connected in series or parallel. CH1 is master and CH2 is slave; no need to connect output leads. In the series mode, the output voltage is doubled; in the parallel mode, the output current is doubled. The isolation degree, from output terminal to chassis or from output terminal to output terminal, is 500V.

Constant Voltage/
Constant Current

Each output channel works in constant voltage (CV) or constant current (CC) mode. Even at the maximum output current, a fully rated, continuously adjustable output voltage is provided. For a big load, the power supply can be used as a CV source; while for a small load, a CC source. When in the CV mode (independent or tracking mode), output current (overload or short circuit) can be controlled via the front panel. When in the CC mode (independent mode only), the maximum (ceiling) output voltage can be controlled via the front panel. The power supply will automatically cross over from CV to CC operation when the output current reaches the target value. The power supply will automatically cross over from CC to CV when the output voltage reaches the target value. For more details about CV/CC mode operation, see page 18.

Automatic tracking mode

The front panel display (CH1, CH2) shows the output voltage or current. When operating in the tracking mode, the power supply will automatically connect to the auto-tracking mode. For more details about CH1/CH2 Series Tracking Mode, see page 30.

Series Lineup / Main Features

Main Features

Performance	<ul style="list-style-type: none">• Low noise: Temperature controlled cooling fan
Operation	<ul style="list-style-type: none">• Constant Voltage / Constant Current operation• Series Tracking / Parallel Tracking operation• Output On/Off control• Multi-output: Two channels V/I are adjustable, and one is fixed;• Function for locking the setting• Output voltage/ current setting view• Set the displayed digit resolution for the voltage & current output.
Protection	<ul style="list-style-type: none">• Overload protection• Key misoperation protection (Lock)• Reverse polarity protection
Interface	<ul style="list-style-type: none">• Remote control (Output ON/OFF)

Principle of Operation

- Overview The power supply consists of the following.
- AC input circuit
 - Transformer
 - Bias power supply including rectifier, filter, pre-regulator and reference voltage source.
 - Main regulator circuit including the main rectifier and filter, series regulator, current comparator, voltage comparator, reference voltage amplifier, remote device and relay control circuit.

The block diagram below shows the CH1 circuit arrangement. The single phase input power is connected to the transformer through the input circuit. Details of each part are described in the next page.

Block diagram

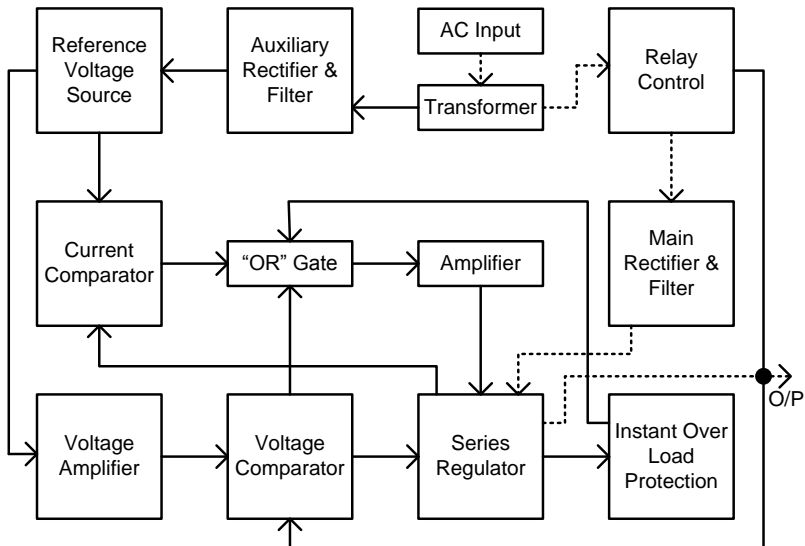

Front Panel Overview

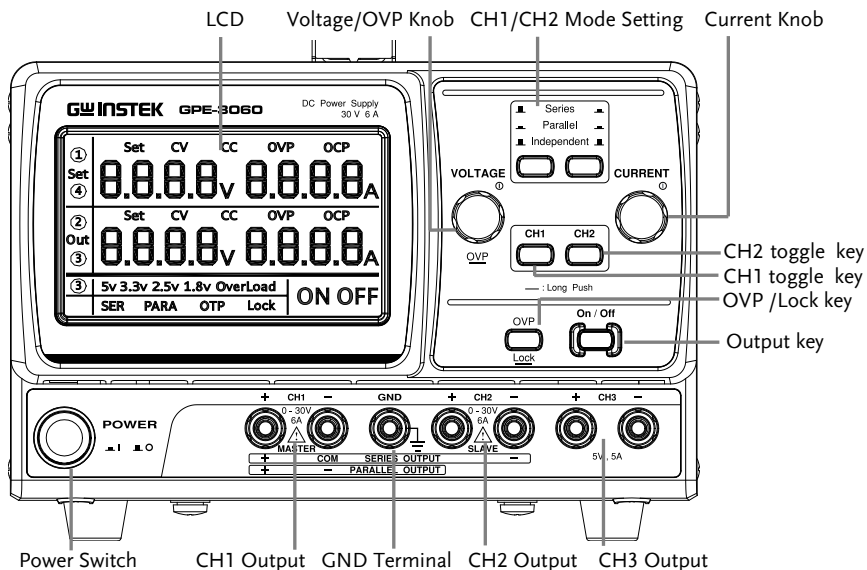

The figure above is the front view of the GPE-3060.

Display

CH1 parameter display area



CH2 parameter display area



CH3 parameter display area



Status display area



Output status display	ON OFF	
Voltmeter	Displays output voltage of CH1/CH2 channel.	
	3 digits:	8.8.8_v
	4 digits:	8.8.8.8_v
	CH3 display:	5_v
Ammeter	Displays output current of CH1/CH2 channel.	
	3 digits:	8.8.8_A
	4 digits:	8.8.8.8_A
CV/CC/OVP indicators for CH1/CH2	CV CC	You can view the constant current, constant voltage or OVP status for Channel (① ② icon appears on the left-hand side of the LCD display). You can view the CV/CC status of the corresponding channel, which is only valid when outputting ON and not displayed when outputting OFF. When OVP is enabled, it is displayed in white, and when it is not enabled, there is no display. After startup, the OVP font flashes.
View setting value	Set	When the channel output is OFF, it is displayed as the set value; When ON, it is displayed as the output value, when there is a set operation, it is displayed as the set value, and the status bar has a Set display..

- Channel indicator ① ② ③ Indicates the currently selected channel.
- Output status of CH3 **OverLoad** When the output current is over range, the overloaded indicator **OverLoad** will be lit on the LCD display.

Control Panel

CH1/CH2

parameter setting

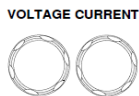

Voltage/Current: When rotate clockwise, the value increases, and rotate counterclockwise, the value decreases. Click on the Encode to enter the setting. Automatically confirm and exit the set state after stopping the operation for a few seconds.



OVP: Press and hold the Encode to enter the OVP setting. When rotating clockwise, the value increases, and rotating counterclockwise, the value decreases. Click the Encode to enter the setting. Automatically confirm and exit the set state after stopping the operation for a few seconds.

CH1/CH2 toggle

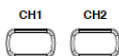

Click on the CH1 or CH2 button (there will be a flashing display of the corresponding channel number on the LCD) to set the voltage/current of this channel or view its readback value.

Parallel/Series
Keys

Activates parallel/series tracking operation. For details, see page 30. The corresponding channel will be displayed on the LCD display.

Enable/Disable
OVP, Lock key



Click this button to enable and disable the OVP function, which can refer to the **OVP** icon display in the status bar; Long time is the Lock function, which can lock or unlock the panel buttons (except for serial and parallel operation and output key functions). The status bar displays **Lock**. For more information, please refer to page **23**.

Output Key



Turns the output on or off. For more details, see page **21**.

Power Switch



Turns On or Off the main power. For the power up sequence, see page **19**.

Terminals

GND Terminal



Accepts a grounding wire.

CH1 Output

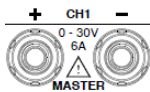

Outputs CH1 voltage and current.

CH2 Output

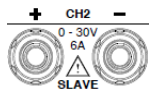

Outputs CH2 voltage and current.

CH3 Output

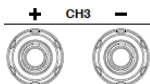

Outputs CH3 voltage and current.

Rear Panel Overview

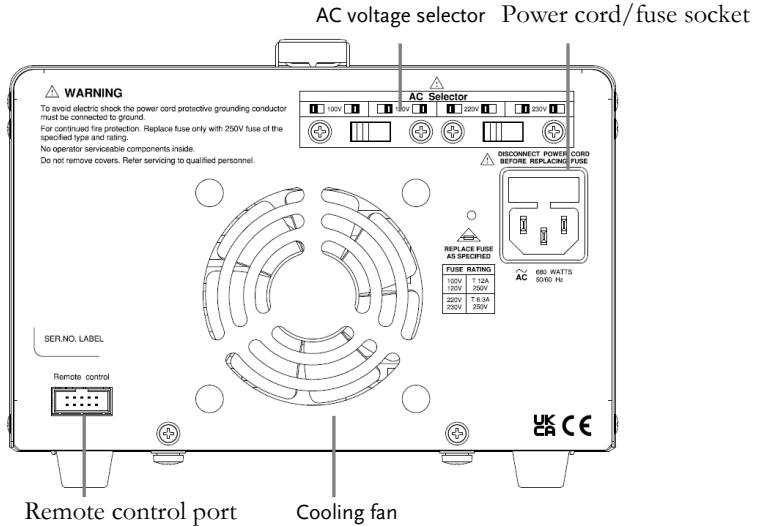

Remote Control Terminal

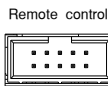

For more information about the remote control terminal, please see page 25.

Power Cord / Fuse Socket

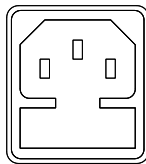

The power cord socket accepts the AC mains. For power up details, see page 19.

The fuse holder contains the AC mains fuse. For fuse replacement details, see page 37.

AC Selector

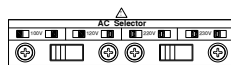

Selects AC input voltage: 100V/ 120V/ 220V/ 230V; 50/60Hz.

CV/CC Crossover Characteristics

Background According to load condition, The GPE can automatically switch between constant voltage mode (CV) and constant current mode (CC).

CV mode When the current level is smaller than the output setting, the GPE series operates in Constant Voltage mode. The **CV** indicator for the corresponding channel appears on the LCD. The Voltage level is kept at the setting and the Current level fluctuates according to the load condition until it reaches the output current setting.

CC mode When the current level reaches the output setting, the GPE series starts operating in Constant Current mode. The **CC** indicator for the corresponding channel appears on the LCD. The Current level is kept at the setting but the Voltage level becomes lower than the setting, in order to suppress the output power level from overload. When the current level becomes lower than the setting, the GPE series goes back to the Constant Voltage mode.

Diagram

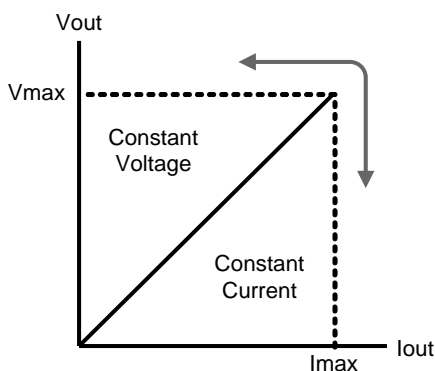

SETUP

This chapter describes how to properly power up and configure the GPE series before operation.

Power Up

Select AC voltage Before powering up the power supply, select the AC input voltage from the rear panel.

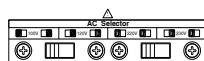

Connect AC power cord Connect the AC power cord to the rear panel socket.

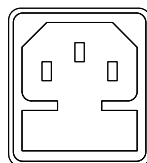

Power On Press the power switch to turn on the power. The display will first display all the LCD segments before showing settings for each channel.



Power Off Press the power switch again to turn off the power.



Load Cable Connection

Standard accessories

1. Turn the terminal counterclockwise and loosen the screw.
2. Insert the cable terminal.
3. Turn the terminal clockwise and tighten the screw.

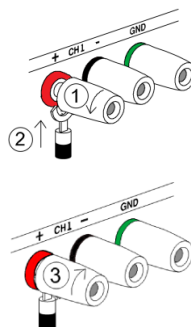

Banana plug

Insert the plug into the socket.

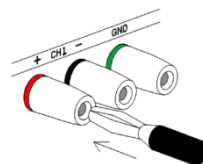

Wire type

When using load cables other than the attached, make sure they have enough current capacity for minimizing cable loss and load line impedance. Voltage drop across a wire should not exceed 0.5V. The following list is the wire current rating at 450A/cm².

Wire size (AWG)	Maximum current (A)
20	2.5
18	4
16	6
14	10
12	16

Output On/Off

Panel operation Press the Output key to turn on all outputs in each channel. The **ON** icon will become lit on the LCD display.

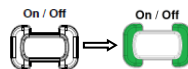

Push the Output key again to turn off all outputs. The **OFF** icon will become lit on the LCD display.



Automatic output off Any of the following actions during output on automatically turns it off.



- Change the operation mode between independent/series tracking/parallel tracking, three channels will be closed together.
- When a single channel OVP is started, the corresponding output will be closed. When CH1/CH2 is simultaneously OVP, three channels will be closed together.

Select CH1/CH2 series or parallel mode

Background / Connection When you need to output a higher voltage or current through the GPE-2323/3323/4323 series can be connected in series or parallel to achieve it. When connecting in series, the output voltage is twice than that of a single channel. When connecting in parallel, the output current is twice than that of a single channel. For details, please see page 30 through to 34.

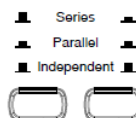
Panel operation You can toggle the connection mode of CH1/ CH2 by using different combinations of the mode selection key.

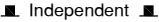
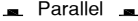

- For the independent mode, the right key is not pressed 
- Toggle to parallel mode when both keys are pressed. 
- Right key is pressed and the left key is not pressed in series mode. 
- When CH1 / CH2 is in the series or parallel mode, the corresponding series or parallel icon appears on the LCD display. 

Setting Lock from Front Panel

Background / Connection The lock function can be used when you need to keep the output constant to avoid the load from being damaged due to inadvertent operation.

Panel operation Press the LOCK key (for more than 2 seconds) to lock the operation in the front panel. The **Lock** icon will become lit.



To unlock, press the LOCK key for more than 2 seconds. The **Lock** icon will then turn off.



Note

- The OUTPUT key is not affected by the lock operation.
- Series and parallel operation is not controlled by the locking key, It will unlock the lock function.

Set the output state at startup

Background / Connection Through the following steps, you can set the output state at its next startup. There are two choices, ON and OFF available for selection.

Panel operation

1. Press and hold the Output key and turn on the power until the **ON** or **OFF** icon flashes on the LCD display.



2. Press the "OVP" key to select.



3. Press the "ON/OFF" key to confirm.



Note

By default the output is set to OFF at startup.

Selection voltage/current display digits

Background / Connection It can set the displayed digit resolution for the voltage and current settings/readings to 3 or 4 digits at startup.

Panel operation

1. Press and hold the "OVP" key and turn the power until on the decimal point for the CH1 voltage flashes on the LCD display.



2. Press the "OVP" key to select the number of displayed digits.



3. Press the "ON/OFF" key to confirm the selection.



Note

By default the number of displayed digits is set to 3.

Remote Control Setting

Background / Connection

Through the "Remote Control" terminal, the GPE can turn the power on or off.

Remote control

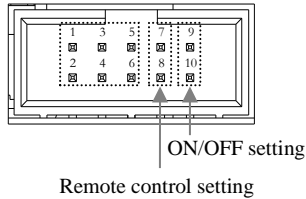

Panel operation

1. Short pins 7 and 8 (remote control setting). This will put the power state (ON/OFF) under remote control. At this moment, the **ON** or **OFF** icon flashes on the LCD display.



2. Output control :

- Pin 9 & 10 Open: ON state.
- Pin 9 & 10 Short: OFF state.



The remote control terminal can only be controlled by shorting (external relay or jumper shunt) / opening the pins. Voltage cannot be applied to the pins. It is strictly prohibited to short pins 5 & 7 or 6 & 8. Pin 1~6 must be set to open.

OPERATION

CH1/CH2 Independent Mode

Background / Connection

CH1 and CH2 outputs work independent of each other.

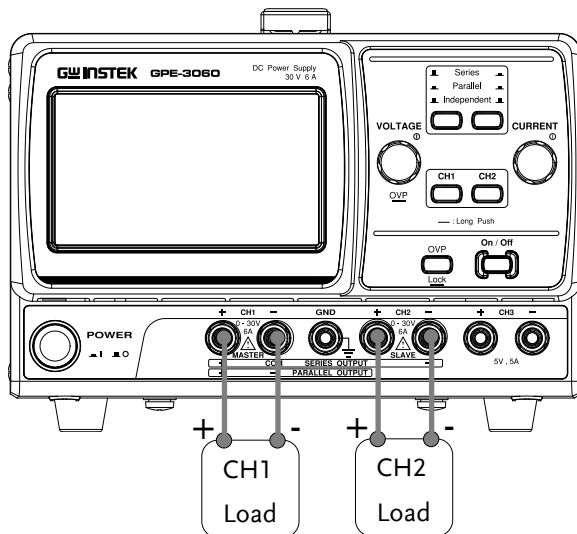

Output rating

Please refer to the specification sheet.

Panel operation

1. Make sure the Series/Parallel key is not activated (both the **SER** and **PARA** icons are off).

■ Independent ■

2. Connect the load to the front panel terminals, CH1 +/-, CH2 +/-.

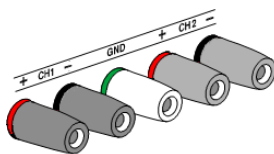

3. Use the voltage and current knob to set the CH1 output voltage and current.

VOLTAGE CURRENT



4. Use the voltage and current knob to set the CH2 output voltage and current.

VOLTAGE CURRENT



5. Press the Output key to turn on the output. The Output key will be lit and the **ON** icon will appear on the LCD display. The **CV** or **CC** icon appears on the LCD to indicate the output status for each channel.

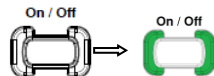

CH3 Independent Mode

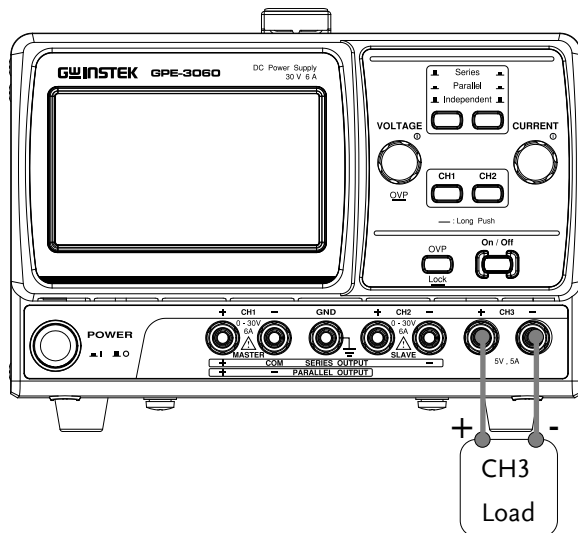

Output rating Please refer to the specification sheet.

No Series/Parallel Tracking CH3 doesn't have series/parallel tracking mode. Also, the CH3 output is not affected by the CH1 and CH2 modes.

Panel operation 1. Connect the load to the front panel CH3 +/- terminal.

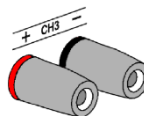

2. Press the Output key to turn on the output. The Output key will be lit.

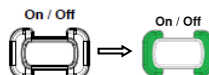

OVERLOAD	When the output current value is too high, the OverLoad icon appears on the LCD display and CH3 operation mode switches from constant voltage to constant current.	OverLoad
----------	---	-----------------

CH1/CH2 Series Tracking Mode

Background Series tracking operation allows the GPE to combine the output by internally connecting CH1 (Master) and CH2 (Slave) in series. CH1 (Master) controls the combined output voltage/current level which is set independently.

The following describes two types of configurations, depending on how common ground is used.

Series Tracking without Common Terminal

Connection

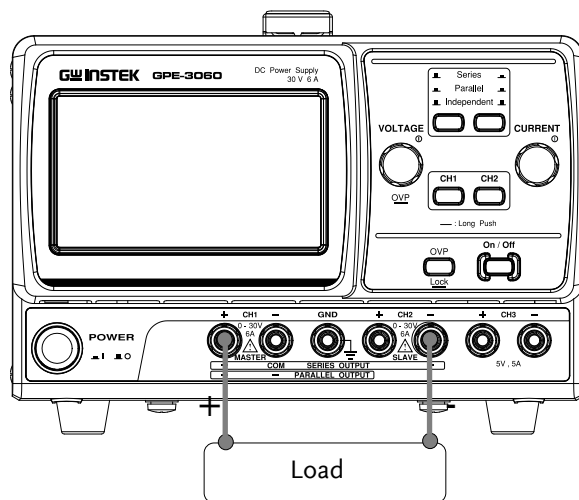

Output rating Please refer to the specification sheet

1. Press the Series/Parallel key to activate the series tracking mode. The **SER** icon will be lit on the LCD display.

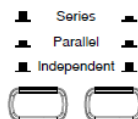

2. Connect the load to the front panel terminals, CH1+ & CH2- (Single supply).

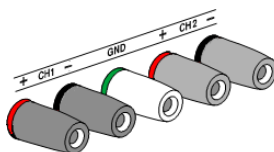

3. Use the current knob to set the CH2 output current to the maximum level.

CURRENT



4. Use the voltage and current knob to set the CH1 output voltage and current level.

VOLTAGE CURRENT



5. Press the Output key to turn on the output. The Output key will be lit.

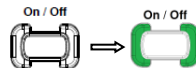

6. Refer to the CH1 (Master) meter and indicators for the output level and CV/CC status.

Output voltage level Double the reading on the CH1 voltage meter.

Output current level CH1 meter reading shows the output current.

Series Tracking with Common Terminal

Connection

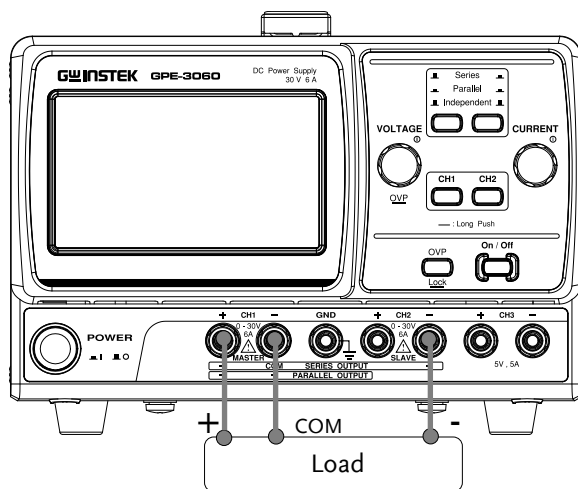

Output rating CH1+ ~ COM ~ CH2- ,
Please refer to the specification sheet.

1. Press the Series/Parallel key to activate the series tracking mode. The **SER** icon will be lit on the LCD display.

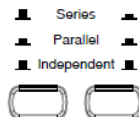

2. Connect the load to the front panel terminals, CH1+ & CH2-. Use the CH1 (-) terminal as the common line connection.

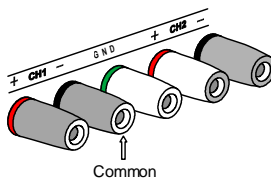

3. Use the CH1 voltage knob to set the master & slave output voltage (the same level for both channels).

VOLTAGE



4. Use the CH1 current knob to set the master output current.

CURRENT



5. Use the CH2 current knob to set the slave output current.

CURRENT



6. Press the Output key to turn on the output. The Output key will be lit.

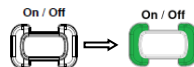

7. Refer to the CH1 (Master) meter and indicators for the output level and CV/CC status.

CH1 (Master) voltage level CH1 meter reading shows the output voltage.

CH1 (Master) current level CH1 meter reading shows the output current.

8. Refer to the CH1/CH2 meter and CH2 indicators for the output level and CV/CC status.

CH2 (Slave) voltage level The CH2 meter reading shows the output voltage.

CH2 (Slave) current level The CH2 meter reading shows the output current.

CH1/CH2 Parallel Tracking Mode

Background /
Connection

Parallel tracking operation allows the GPE to combine the output by internally connecting CH1 (Master) and CH2 (Slave) in parallel. CH1 (Master) controls the combined output voltage/current level.

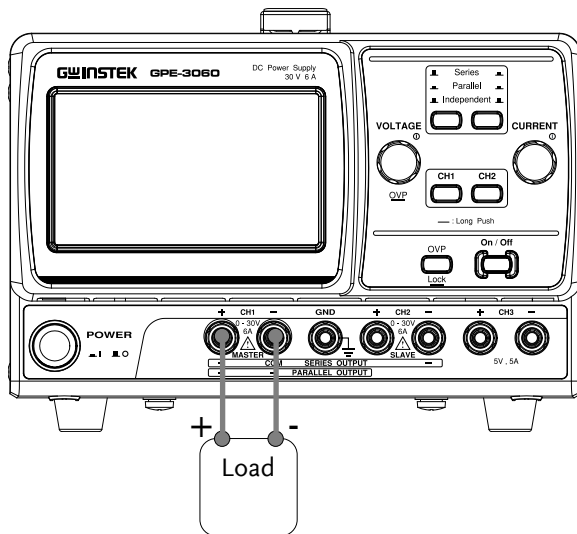

Output rating

Please refer to the specification sheet

1. Press the Series/Parallel key to activate the parallel tracking mode. The **PARA** icon will be lit on the LCD display.

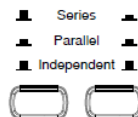

2. Connect the load to the CH1 +/- terminals.

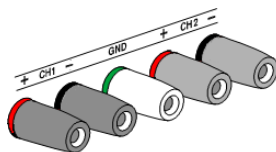

- Use the CH1 voltage and current knobs to set the output voltage and current. CH2 control function is disabled.

VOLTAGE CURRENT



- Press the Output key to turn on the output. The Output key will be lit.

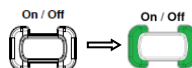

- The operating mode of CH2 will appear as the **CC** icon on the LCD display.

- Refer to the CH1 meter and indicator for the output level and CV/CC status.

Output voltage level The CH1 meter reading shows the output voltage.

Output current level Double the amount of CH1 current meter reading.

FAQ

Q1. I pressed the panel lock key but the output still turns on/off.

A1. For safety reasons the output key is not affected by the panel key lock feature.

Q2. The CH3 overload indicator turned on – is this an error?

A2. No, it simply means that the CH3 output current reached the maximum 5.2A and the operation mode turned from CV (constant voltage) to CC (constant current). You can continue using the power supply, although reducing the output load is recommended.

Q3. The specifications do not match the real accuracies.

A3. Make sure that the power supply is powered on for at least 30 minutes, within +20°C ~ +30°C.

For more information, contact your local dealer or GWInstek at www.gwinstek.com.tw / marketing@goodwill.com.tw

APPENDIX

Fuse Replacement

Steps

1. Take off the power cord and remove the fuse socket using a minus driver.

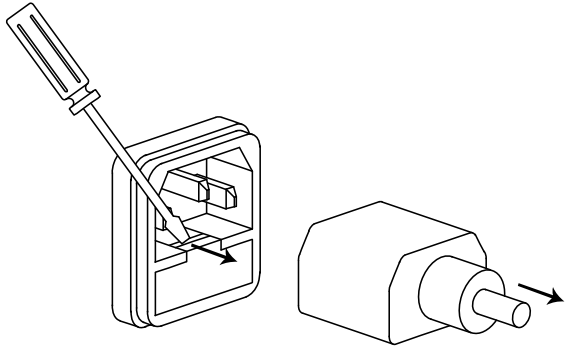

2. Replace the fuse in the holder.

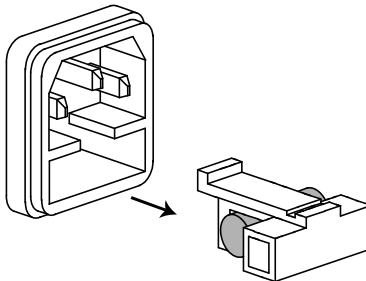

Rating

- 100V/120V:T12A/250V
- 220V/230V:T6.3A/250V

Specifications

The specifications apply when the GPE are powered on for at least 30 minutes under +20°C - +30°C.

CH1/ CH2	Independent	0 ~ 30V, 0 ~ 6A (GPE-3060) 0 ~ 60V, 0 ~ 3A (GPE-6030)	
	Output Ratings	Series	0 ~ 60V, 0 ~ 6A (GPE-3060) 0 ~ 120V, 0 ~ 3A (GPE-6030)
Parallel		0 ~ 30V, 0 ~ 12A (GPE-3060) 0 ~ 60V, 0 ~ 6A (GPE-6030)	
Voltage Regulation	Line Regulation	≤ 0.01% + 3mV	
	Load Regulation	≤ 0.01% + 5mV ≤ 0.02% + 5mV (≥ 10A)	
		Ripple & Noise	≤ 1mVrms (5Hz ~ 1MHz)
	Recovery Time	≤ 100μs (50% load change, minimum load 0.5A)	
	Temperature Coefficient	≤ 300ppm/°C	
Current Regulation	Line Regulation	≤ 0.1% + 3mA	
	Load Regulation	≤ 0.1% + 3mA	
	Ripple & Noise	≤ 2mArms	
OVP	Range	OFF, ON (1V ~ 35V) (GPE-3060) OFF, ON (1V ~ 65V) (GPE-6030)	
	Resolution	1V	
	Accuracy	≤ ±1V	
Tracking Operation	Output tracking Error	≤ 0.1% + 10mV of Master (GPE-3060) ≤ 0.2% + 20mV of Master (GPE-6030) (No Load, with load add load regulation ≤ 200mV)	
	Parallel Regulation	Line: ≤ 0.01% + 3mV Load: ≤ 0.01% + 5mV ≤ 0.02% + 5mV (≥ 10A)	
		Ripple & Noise:	≤ 2mVrms (5Hz ~ 1MHz)
	Series Regulation	Line: ≤ 0.01% + 5mV Load: ≤ 200mV Ripple & Noise:	≤ 2mVrms (5Hz ~ 1MHz)

Meter Display	LCD	4.3" single color LCD
	Setting/Read back Resolution	Voltage(4digits): 10mV (GPE-3060) / 20mV (GPE-6030) Current(4digits): 2mA (GPE-3060) / 1mA (GPE-6030)
	Setting/Read back Accuracy	Voltage: $\pm(0.1\% \text{ of reading} + 30\text{mV})$ (4digits) $\pm(0.1\% \text{ of reading} + 200\text{mV})$ (3digits) Current: $\pm(0.3\% \text{ of reading} + 10\text{mA})$ (4digits) $\pm(0.3\% \text{ of reading} + 20\text{mA})$ (3digits)
	CH3	Voltage 5V $\pm 5\%$ Current 5A
Output	Line Regulation	$\leq 3\text{mV}$
	Load Regulation	$\leq 5\text{mV}$
	Ripple & Noise	$\leq 1\text{mVrms}$ (5Hz ~ 1MHz)
	Recovery Time	$\leq 100\mu\text{s}$
	OVP	5.5V
Insulation	Chassis and Terminal	20M Ω or above (DC 500V)
	Chassis and AC cord	30M Ω or above (DC 500V)
Operation Environment	Indoor use, Altitude: $\leq 2000\text{m}$ Ambient temperature: 0 ~ 40°C Relative humidity: $\leq 80\%$ Installation category: II Pollution degree: 2	
Storage Environment	Ambient temperature: -10 ~ 70°C Relative humidity: $\leq 70\%$	
Power Source consumption	AC 100V/120V/220V/230V $\pm 10\%$, 50/60Hz 900VA, 680W	
Accessories	Quick Start manual x1 Test lead: Non-European: GTL-104A x3 Test lead: European: GTL-204A x 3 , GTL-201A x1	
Dimensions	210 (W) x 155 (H) x 360 (D) mm	
Weight	Approx. 10kg	

Declaration of Conformity

We

GOOD WILL INSTRUMENT CO., LTD.

declare that the CE marking mentioned product satisfies all the technical relations application to the product within the scope of council:

Directive: EMC; LVD; WEEE; RoHS

The product is in conformity with the following standards or other normative documents:

© EMC

EN 61326-1 :	Electrical equipment for measurement, control and laboratory use — EMC requirements	
Conducted & Radiated Emission EN 55011 / EN 55032	Electrical Fast Transients EN 61000-4-4	
Current Harmonics EN 61000-3-2 / EN 61000-3-12	Surge Immunity EN 61000-4-5	
Voltage Fluctuations EN 61000-3-3 / EN 61000-3-11	Conducted Susceptibility EN 61000-4-6	
Electrostatic Discharge EN 61000-4-2	Power Frequency Magnetic Field EN 61000-4-8	
Radiated Immunity EN 61000-4-3	Voltage Dip/ Interruption EN 61000-4-11 / EN 61000-4-34	

© Safety

EN 61010-1 :	Safety requirements for electrical equipment for measurement, control, and laboratory use - Part 1: General requirements
--------------	--

GOOD WILL INSTRUMENT CO., LTD.

No. 7-1, Jhongsing Road, Tucheng Dist., New Taipei City 236, Taiwan

Tel: +886-2-2268-0389

Fax: +866-2-2268-0639

Web: www.gwinstek.com

Email: marketing@goodwill.com.tw

GOOD WILL INSTRUMENT (SUZHOU) CO., LTD.

No. 521, Zhujiang Road, Snd, Suzhou Jiangsu 215011, China

Tel: +86-512-6661-7177

Fax: +86-512-6661-7277

Web: www.instek.com.cn

Email: marketing@instek.com.cn

GOOD WILL INSTRUMENT EURO B.V.

De Run 5427A, 5504DG Veldhoven, The Netherlands

Tel: +31(0)40-2557790

Fax: +31(0)40-2541194

Email: sales@gw-instek.eu

INDEX

Automatic out off	21	Ground symbol	5
Banana plug	20	Load connection.....	20
Caution symbol	5	Operation mode	
CC/CV	29	Independent	26
Cleaning the instrument.....	6	Parallel Tracking	34
Common terminal, series		Series Tracking.....	30
tracking	30	Output current setting	
Cooling fan.....	17	Manual	27
safety instruction.....	6	Output on/off	
CV/CC		FAQ	36
CH1/CH2 indicator	27	manual.....	21
CH3 indicator.....	29	Output voltage setting	
Operation theory	9, 18	Manual	27
Disposal instructions	7	Over load indicator	29
EN61010		Power supply	
Pollution degree	7	Safety instruction.....	6
Environment		Setup.....	19
Operation.....	7	Socket overview	17
Specification	39	Specification	39
Storage	7	Protective ground symbol	5
Front panel		remote output control	
Lock (manual)	23	terminal overview.....	17
Overview	13	Service operation	
Fuse		About disassembly	6
Rating.....	37	Contact	36
Replacement.....	37	tracking mode	
Safety instruction.....	6	parallel.....	23, 24, 25
GPE series		Tracking mode	
Block diagram.....	11	Operation theory.....	8
List of features	10	Warning symbol	5
Operation theory	11	Wire, load.....	20