

Resistance Meter

RM3545A-1

RM3545A-2

RM3546

Datasheet



Product Overview

To prevent the instrument temperature from increasing, place the instrument away from surrounding items with the minimum distances specified.

- Weld resistance in batteries, motors, and other devices
- Winding resistance in motors, transformers, and other devices
- Contact resistance in relays and switches
- Pattern resistance on printed circuit boards
- DC resistance of fuses, resistors, conductive rubber, and other materials

Since the instrument incorporates a temperature correction function, it is particularly well suited to the measurement of targets whose resistance values vary with temperature. The instrument also provides functions such as those of comparator, communications, external control, and multiplexer devices*1, allowing it to be used in a wide range of applications, including in development work and on production lines.

*1. The RM3545A-2 and RM3546 can be used for multiplexer-related control.

Measurement principle

When a current (I) is applied to the measurement target, a voltage (V) occurs in its resistance (R). This leads to the relationship $R=V/I$. Using the expression, the resistance (R) can be calculated.

Two-terminal measurement method

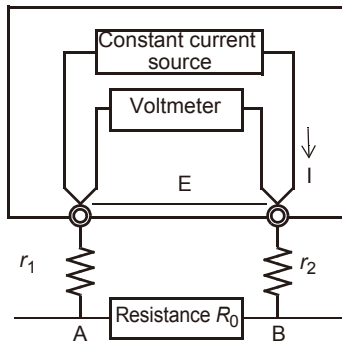

Figure 1.

Four-terminal measurement method

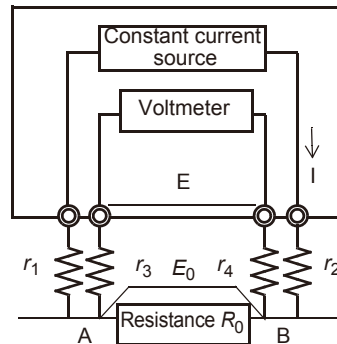

Figure 2.

Features

High-performance specifications to meet advanced development and production needs

Broad measurement range: 1000 $\mu\Omega$ to 1000 M Ω

Maximum accuracy: 0.006% of reading + 0.001% of full scale

Maximum resolution: 1 n Ω

Low-resistance measurement of current detection resistors, reactors, welds, etc. is supported.

Up to 1 G Ω range

Discharge voltage of 20 mV or less **RM3545A-1** **RM3545A-2**

Low-power measurement can be used in testing under IEC 60512-2 and other contact standards.

Accuracy defined without zero adjustment

Route resistance*¹ tolerance in low-resistance range: 3.5 Ω (PR mode: ON)

Measurement cables can be extended easily, even when using the 1 A measurement current range.

Route resistance*¹ tolerance further facilitating incorporation into automated systems: 9 Ω (500 mA range, PR mode: ON) **RM3546**

An A-OVC function allowing accurate measurements even when the temperature is varying **RM3546**

The performance is improved from the normal OVC function.

An advanced temperature correction (A-TC) function allowing conversion to resistance values at ambient temperature even when the temperature is high **RM3546**

Even when the temperature is high, such as after welding, measured values can be converted to values at ambient temperature without temperature measurement.

*1. Route resistance is the total of all resistance components downstream from the instrument (wiring resistance + contact resistance).

An ACP function allowing safe measurement of battery packs

(withstanding voltage of 60 V) **RM3546**

If an over-input is detected, the protection circuit is activated and stops the measurement to prevent downtime due to malfunction.

ACP (Active Circuit Protection) function

If an over-voltage exceeding the shutoff voltage is applied between the measurement terminals, the measurement circuit inside the instrument is automatically shut off for protection.

Therefore, no failure occurs even if a maximum voltage of ± 60 V DC, or 30 V AC rms and 42.4 V AC peak is accidentally applied between the measurement terminals A and B (no failure occurs even if the battery voltage or the motor back EMF is accidentally applied).

If such a voltage is accidentally applied, **[Err:700]** is displayed on the screen and the “PROTECT” signal is output to the EXT. I/O. Measurement will resume when the voltage across the A and B measurement terminals falls to or below the reconnect voltage.

SOURCE (between A and B)

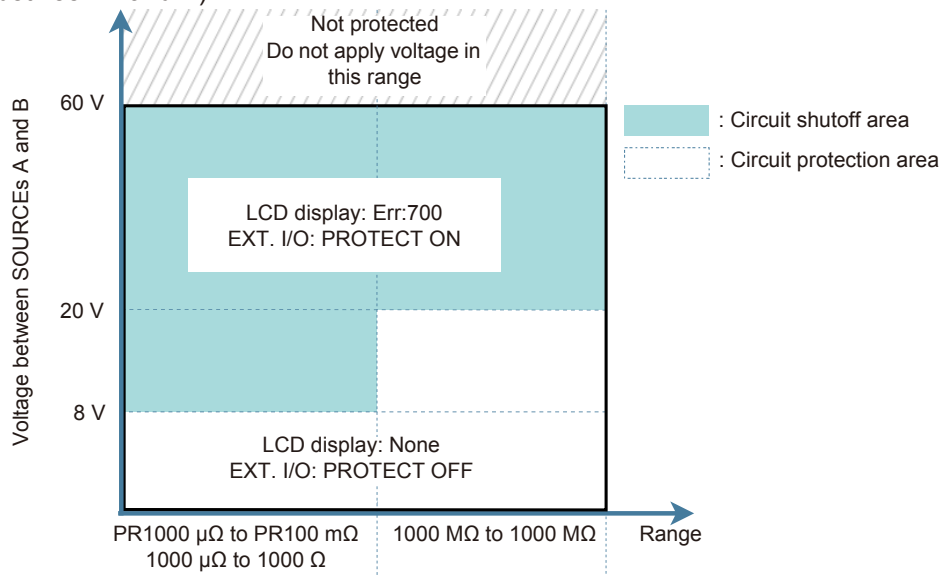

SENSE (between A and B)

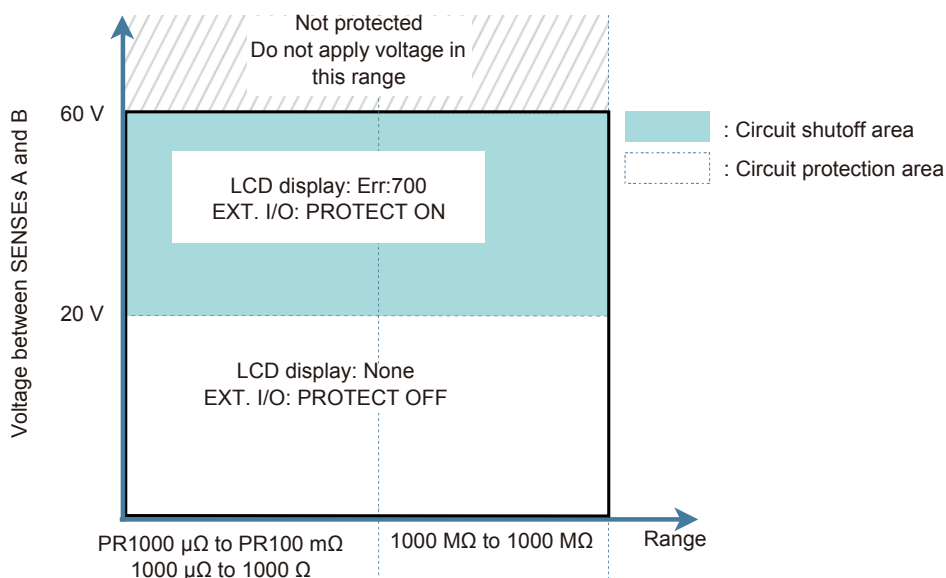

Package Contents

Main body

- RM3545A-1, RM3545A-2 or RM3546 Resistance Meter
(RM3545A-2 and RM3546 are provided with multiplexer slots.)



Included accessories

- Power cord
- Z2001 Temperature Sensor
- EXT. I/O connector (male)
- EXT. I/O connector cover
- Spare fuse (F1.6AH/250V)
 - RM3545A-1 Supplied
 - RM3545A-2 Supplied
 - RM3546 Not supplied
- Startup Guide
- Operating Precautions (0990A905)

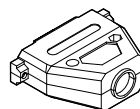
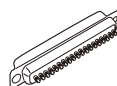

Options

- L2100 Pin Type Lead (for low resistance only*1)



- RM9010-01 Four-Point Array Probe (Pin pitch: 5.0 mm)



- L2101 Clip Type Lead



- RM9010-02 Four-Point Array Probe (Pin pitch: 1.5 mm)

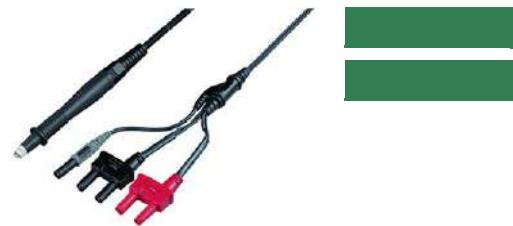

- L2102 Pin Type Lead



- L2105 LED Comparator Attachment



- L2103 Pin Type Lead



*1. "Low resistance" refers to the following ranges, all of which have a measurement current of at least 100 mA. Other ranges fall outside the scope of the accuracy guarantee.
 1000 $\mu\Omega$ range (High, Low), 10 m Ω range (High, Low), 100 m Ω range (High, Low),
 1000 m Ω range (High only)

- Z5038 0 ADJ Board



- L9637 RS-232C Cable
(9-pin to 9-pin, 3.0 m, crossover cable, double shield)



- Z2001 Temperature Sensor



- 9642 LAN Cable



- Z3003 Multiplexer Unit
(RM3545A-2 and RM3546 only)



- L1002 USB Cable (A-B type)



- Z5056 Fuse Set (5 pieces)

- L9773 Probe Kit
(L9773-01, L9773-02 and L9773-03 included)

- L9773-01 Probe Tips (10 pieces)

- L9773-02 Probe Tip Sockets (10 pieces)

- L9773-03 Probe Tip Socket Adapters (10 pieces)





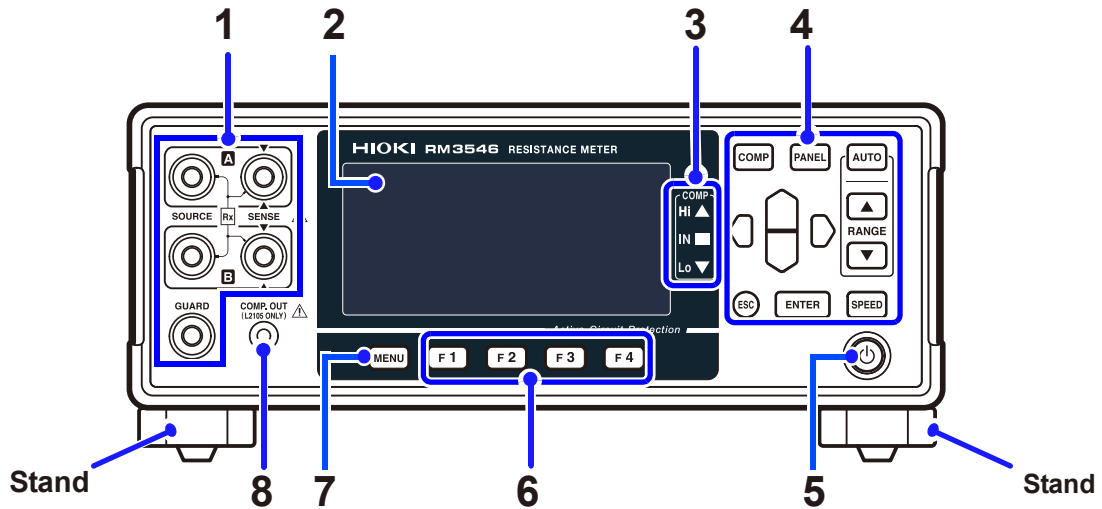



Part Names and Functions

Front (The figures show the RM3546)



Number	Name	Function
1	Measurement terminals	Connect the measurement leads. <ul style="list-style-type: none"> • SOURCE A: Current detection terminal • SOURCE B: Current source terminal • SENSE A: Voltage detection terminal • SENSE B: Voltage detection terminal • GUARD: Guard terminal
2	Display screen	Displays the settings and the measured values.
3	COMP indicator LEDs	Indicate the judgment result of the measured value when using the comparator function. <ul style="list-style-type: none"> Hi Upper limit value < measured value IN Pass (meets criteria) Lo Lower limit value > measured value
4	Operation keys	See the following page.
5	STANDBY key	Initiates or cancels the standby state. <ul style="list-style-type: none"> Unlit: Power off (when no power supplied) Red light: Standby state (while power is supplied) Green light: Power on
6	F keys (F1 to F4)	Selection of settings displayed on the screen.
7	MENU key	Displays the Settings screen or switches the pages.
8	COMP.OUT terminal	Connect the L2105 LED Comparator Attachment.

Operation keys

Key	Name	Function
	COMP key	Sets the comparator function.
	PANEL key	Saves or loads the settings. (Panel Save function, Panel Load function)
	AUTO key	Switches between the auto range and the manual range.
	RANGE key	Switches the measurement range when the manual range is selected.
	Cursor key	Moves among items shown on the screen.
	ESC key	Cancels the settings displayed on the screen.
	ENTER key	Confirms the settings displayed on the screen.
		Allows manual measurement when using the external trigger [EXT] setting.
	SPEED key	Switches the measurement speed.

Rear (The figures show the RM3545A-2)

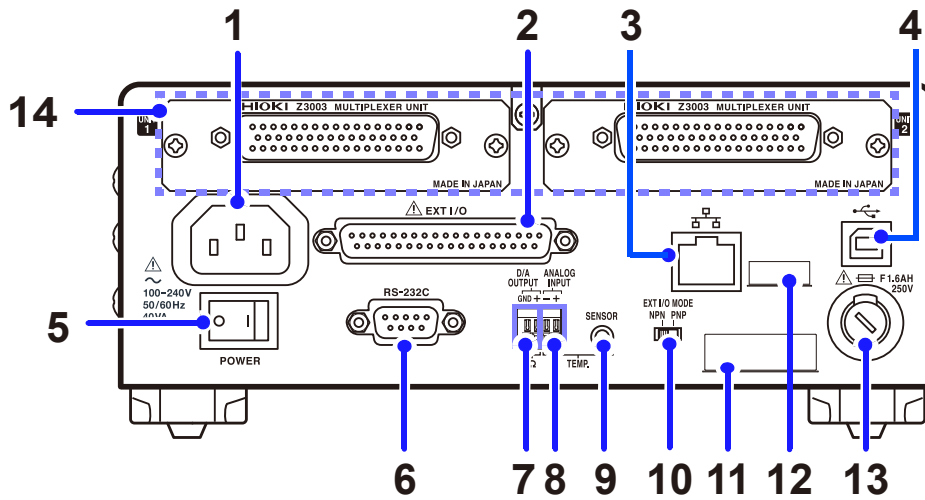

Number	Name	Description
1	Power inlet	Connect the included power cord.
2	EXT. I/O connector	Allows external control of the instrument.
3	LAN connector	Allows control of the instrument with a PC or PLC* ¹ through LAN communication (socket communication). The measurement data can be transferred to a PC.
4	USB connector	Allows control of the instrument with a PC or PLC* ¹ through USB communication (virtual COM port). The measurement data can be transferred to a PC.
5	Main power switch	Switches On/Off the main power supply of the instrument.
6	RS-232C connector	Allows control of the instrument with a PC or PLC* ¹ through RS-232C communication (serial communication). The measurement data can be transferred to a PC. Connect a printer to the instrument.
7	D/A OUTPUT terminal	Outputs a voltage level that correspond to the resistance value. Connect a device that can accept voltage input, for example, a Memory HiCorder.
8	TEMP. ANALOG INPUT terminal	Connect an analog output thermometer.
9	TEMP. SENSOR terminal	Connect the Z2001 Temperature Sensor.
10	EXT. I/O MODE selection switch (NPN/PNP)	Allows you to change the type of PLC* ¹ to be connected with the EXT. I/O connector. Left: Current sink (NPN) Right: Current source (PNP)
11	Manufacturing number (serial number)	For the latest information, check Hioki's website. Do not remove this label, as it is required for product support.

Number	Name	Description	See
12	MAC address	MAC address of LAN	—
13	Fuse holder RM3545A-1 RM3545A-2	For replacement of the fuse.	p.335
14	Multiplexer unit slot RM3545A-2 RM3546	Install the Z3003 Multiplexer Unit. (Max. 2)	p.45

*1. Programmable controller

Comparison with the Previous Products

The following table provides comparisons between the previous products (RM3545 series) and the current products (RM3545A-1, RM3545A-2, RM3546).

Available: ✓, Not available: –

Specifications, functions	RM3545 series			RM3545A-1	RM3545A-2	RM3546	
	RM3545	RM3545-01	RM3545-02				
Maximum allowable voltage	–					±60 V DC, or 30 V AC rms and 42.4 V AC peak	
Minimum measurement range	10 mΩ			1000 μΩ			
Maximum resolution	10 nΩ			1 nΩ			
Measurement range	0.000 00 mΩ (10 mΩ range) to 1200.0 MΩ (1000 MΩ range), 12 ranges			0.000 μΩ (1000 μΩ range) to 1200.0 MΩ (1000 MΩ range), 13 ranges			
Measurement current	1 A						
	–					500 mA	
	100 mA, 10 mA, 1 mA, 500 μA, 100 μA, 50 μA, 10 μA, 5 μA, 1 μA, 1 μA or less, 100 nA						
Offset voltage compensation	OVC				OVC or A-OVC		
Temperature correction	TC				TC or A-TC		
Maximum allowable route resistance (reference value)	1.5 Ω			3.5 Ω (PR: On) 2.6 Ω (PR: Off)			
	500 mA range		–				9 Ω (PR: On) 6.1 Ω (PR: Off)
Pure resistance mode (PR)	–			1000 μΩ, 10 mΩ, 100 mΩ ranges			
Low-power mode (LP)	1000 mΩ, 10 Ω, 100 Ω, 1000 Ω ranges					–	
Interface	USB	✓					
	RS-232C	✓					
	LAN	–			✓		
	GP-IB	–	✓	–			
EXT. I/O	✓						
Multiplexer	–		Max. 2 ^{*1}	–		Max. 2 ^{*1}	
Fuse	F1.6AH/250 V (replaceable)					Protected by internal circuitry (not replaceable)	
Dimensions	Approx. 215W × 80H × 306.5D mm (8.46W × 3.15H × 12.07D in.)						
Weight	Approx. 2.5 kg (5.5 lb.)		Approx. 3.2 kg (7.1 lb.)	Approx. 2.7 kg (6.0 lb.)		Approx. 3.4 kg (7.5 lb.)	

*1. 2-wire: Max. 21 channels/unit, 4-wire: Max. 10 channels/unit

General Specifications

Operating environment	Indoor use, pollution degree 2, altitude up to 2000 m (6562 ft.)	
Operating temperature and humidity range	0°C to 40°C (32°F to 104°F), 80% RH or less (non-condensing)	
Storage temperature and humidity range	-10°C to 50°C (14°F to 122°F), 80% RH or less (non-condensing)	
Standards	Safety EN 61010 EMC EN 61326 Class A	
Power supply	Rated supply voltage	Commercial power supply 100 V to 240 V AC (Voltage fluctuations of ±10% from the rated supply voltage are taken into account)
	Rated power-supply frequency	50 Hz/60 Hz
	Anticipated transient overvoltage	2500 V
	Maximum rated power	RM3545A: 40 VA RM3546: 48 VA
	Normal power consumption (reference value)	RM3545A: 16 W (measurement current 1 A, LCD on) RM3546: 20 W (measurement current 1 A, LCD on)
Backup battery life	Approx. 10 years (reference value at 23°C)	
Interfaces	LAN, USB, RS-232C	
Dimensions	Approx. 215W × 80H × 306.5D mm (8.46W × 3.15H × 12.07D in.)(except protruding parts)	
Weight	Approx. 2.7 kg (6.0 lb.) (RM3545A-1) Approx. 3.4 kg (7.5 lb.) (RM3545A-2, RM3546)	
Product warranty duration	3 years	
Fuse (RM3545A-1 and RM3545A-2 only)	F1.6AH 250 V (installed inside the main body, replaceable)	

Input Specifications/Output Specifications/ Measurement Specifications

Basic specifications

Measurement items	Resistance, temperature			
Measurement range	Resistance			
		100 MΩ range High-precision	Measuring range and full scale	Number of ranges
OFF	-	OFF	000.000 μΩ (1000 μΩ range) to 1200.0 MΩ (1000 MΩ range) 10 MΩ range or less: full scale = 1,000,000 digits 100 MΩ range or greater: full scale = 10,000 digits	13
		ON	000.000 μΩ (1000 μΩ range) to 120.000 0 MΩ (100 MΩ range) Full scale = 1,000,000 digits	12
ON	OFF	-	0.00 mΩ (1000 mΩ range) to 1200.00 Ω (1000 Ω range) Full scale = 100,000 digits	4
*1. Low-power mode (RM3545A only)				
*2. Pure resistance mode				
Temperature: -10.0°C to 99.9°C				
Maximum allowable voltage(RM3546 only)	±60 V DC, or 30 V AC rms and 42.4 V AC peak (between terminals) Resistance measurement cannot be performed when voltage is applied			
Measurement signal	Constant current			
Measurement method	DC four-terminal method			
Measurement current	1 A, 500 mA (RM3546 only), 100 mA, 10 mA, 1 mA, 500 μA, 100 μA, 50 μA, 10 μA, 5 μA, 1 μA, 1 μA or less, 100 nA Depends on the measurement ranges			
Measurement terminals	Banana terminals SOURCE A terminal Current detection terminal SOURCE B terminal Current source terminal SENSE A terminal Voltage detection terminal SENSE B terminal Voltage detection terminal GUARD terminal Guard terminal			

Measurement time

Resistance measurement (tolerance: ±10% ±0.2 ms)

- (1) When using the internal trigger source with continuous measurement on (free-run): Time of 1 measurement when the measurement target is connected

Calculation formulas

	OVC* ¹ or A-OVC* ¹
OFF	$E1 + (D + F) \times N + G$
ON	$(C + D + E1 + E2 + F) \times 2 \times N + G$

- (2) When using an external trigger source or with continuous measurement off (non-free-run): From trigger input until EOM turns on

Calculation formulas

	OVC* ¹ or A-OVC* ¹
OFF	$A + B + C + E2 + (D + E1) \times N + F + G$
ON	$A + B + (C + D + E1 + E2 + F) \times 2 \times N + G$

*1. In the 1000 μΩ range, OVC or A-OVC are fixed to on.

Calculate the measurement time with (1) and (2) by substituting the following values of *A* to *G* and *N* into the calculation formulas.

A: Trigger detection time (unit: ms) *B*: Contact improvement time (unit: ms) *C*: Delay setting (unit: ms)

TRIG logic setting	Time
ON edge	0.1
OFF edge	0.3

Contact improvement function	Time
OFF	0.0
ON	0.2

Time
Varies with setting.

D: Integration time (unit: ms) (detected voltage data acquisition time)

LP	Range	FAST		MEDIUM		SLOW1	SLOW2
		50 Hz	60 Hz	50 Hz	60 Hz		
OFF	1000 kΩ or less	0.3* ¹		20.0	16.7	100	200
	10 MΩ or more	20.0	16.7	20.0	16.7	100	200
ON* ²	All ranges	20.0	16.7	40.0	33.3	200	300

*1. When using the MUX measurement terminals, the integration time is 1.0 ms in the 1000 μΩ range and 10 mΩ range.

*2. RM3545A only

E1: Internal wait time 1 (unit: ms) (Processing time before and after integration measurement)

Time
0.3

E2: Internal wait time 2 (unit: ms) (Processing time before and after integration measurement)

LP: Off and PR: Off

Range	Measurement current	Time	100 MΩ Range High-precision mode	
1000 μΩ	High	40	-	
	Low*1	100		
10 mΩ	High	40		
	Low*1	100		
100 mΩ	High	40		
	Low	2.1		
1000 mΩ	High	2.3		
	Low	1.3		
10 Ω	High	1.5		
	Low	1.8		
100 Ω	High	1.6		
	Low	2.1		
1000 Ω	-	2.1		
10 kΩ		6.0		
100 kΩ		16		
1000 kΩ		130		
10 MΩ		500		
100 MΩ			1300	ON
			320	OFF
1000 MΩ			340	OFF

*1. RM3546 only

PR: On

Range	Measurement current	Time
PR1000 μΩ	High	20
	Low*1	20
PR10 mΩ	High	20
	Low*1	20
PR100 mΩ	-	20

LP: On (RM3545A only)

Range	Time
LP1000 mΩ	15
LP10 Ω	35
LP100 Ω	35
LP1000 Ω	36

F: Calculation time (unit: ms)

Setting	Time
Statistical calculation: OFF Scaling: OFF Measured value display switching: None	0.1

G: Self-calibration time (unit: ms)

Self-calibration setting	Time
Auto	5.0
Manual	0.0

N: Number of averaging iterations*4

Trigger source, continuous measurement	Number of iterations
When using the INT trigger source with continuous measurement on (free-run)	1*2 (Moving Avg.)
When using an EXT trigger source or with continuous measurement off (non-free-run)	Varies with setting. *3

*2. Calculate with N = 1, irrespective of the set number of average iterations.

*3. When using the SLOW2 measurement speed with LP on, calculate with N = 2 even if the averaging is set to off. (RM3545A only)

*4. For the RM3546, if A-OVC is set to ON, the averaging is enabled even when the number of averaging iterations is OFF.

- (3) Shortest measurement times when using the INT trigger source with continuous measurement on (free-run)
(unit: ms)

LP: Off (tolerance: ±10% ±0.2 ms)

Range	FAST		MEDIUM		SLOW1	SLOW2
	50 Hz	60 Hz	50 Hz	60 Hz		
1000 kΩ or less	1.0* ¹		20.7	17.4	101	201
10 MΩ or more	20.7	17.4	20.7	17.4	101	201

*1. When using the MUX measurement terminals, the shortest measurement time is 1.7 ms in the 1000 μΩ range and 10 mΩ range.

LP: On (tolerance: ±10% ±0.2 ms, only with OVC is on) (RM3545A only)

Range	FAST		MEDIUM		SLOW1	SLOW2
	50 Hz	60 Hz	50 Hz	60 Hz		
LP1000 mΩ	71	64	111	98	431	631
LP10 Ω	111	104	151	138	471	671
LP100 Ω	111	104	151	138	471	671
LP1000 Ω	113	106	153	140	473	673

Shortest conditions

Delay: 0 ms, OVC: Off, Self-calibration: MANUAL,

Contact improvement: Off, Scaling: Off

Measured value display switching: none

(4) Shortest measurement times when using the EXT trigger source or when continuous measurement off (non-free-run) (unit: ms)

LP: Off and PR: Off (tolerance: ±10% ±0.2 ms)

■ RM3546 (if AVERAGE is set to 2)

Range	Measurement current	A-OVC	FAST		MEDIUM		SLOW1	SLOW2	100 MΩ range High-precision mode
			50 Hz	60 Hz	50 Hz	60 Hz			
1000 μΩ	High	OFF	-	-	-	-	-	-	
		ON	163		242	229	562	962	
	Low	OFF	-	-	-	-	-	-	
		ON	403		482	469	802	1202	
10 mΩ	High	OFF	41		81	74	241	441	
		ON	163		242	229	562	962	
	Low	OFF	101		141	134	301	501	
		ON	403		482	469	802	1202	
100 mΩ	High	OFF	41		81	74	241	441	
		ON	163		242	229	562	962	
	Low	OFF	3.5		43	36	203	403	
		ON	11		90	77	410	810	
1000 mΩ	High	OFF	3.7		43	37	203	403	
		ON	12		91	78	411	811	
	Low	OFF	2.7		42	36	202	402	
		ON	8.1		87	74	407	807	
10 Ω	High	OFF	2.9		42	36	202	402	
		ON	8.9		88	75	408	808	
	Low	OFF	3.2		43	36	203	403	
		ON	10		89	76	409	809	
100 Ω	High	OFF	3.0		42	36	202	402	
		ON	9.3		88	75	408	808	
	Low	OFF	3.5		43	36	203	403	
		ON	11		90	77	410	810	
1000 Ω	-	OFF	3.5		43	36	203	403	
		ON	11		90	77	410	810	
10 kΩ			7.4		47	40	207	407	
100 kΩ			17		57	50	217	417	
1000 kΩ			131		171	164	331	531	
10 MΩ			541	534	541	534	701	901	
100 MΩ			1341	1334	1341	1334	1501	1701	ON
			361	354	361	354	521	721	OFF
1000 MΩ		381	374	381	374	541	741	OFF	

■ **RM3545A, RM3546 (if AVERAGE is set to off)**

Range	Measurement current	OVC	FAST		MEDIUM		SLOW1	SLOW2	100 MΩ range High-precision mode
			50 Hz	60 Hz	50 Hz	60 Hz			
1000 μΩ	High	OFF	-	-	-	-	-	-	-
		ON	82	121	114	281	481		
	Low*1	OFF	-	-	-	-	-	-	
		ON	202	241	234	401	601		
10 mΩ	High	OFF	41	61	57	141	241		
		ON	82	121	114	281	481		
	Low*1	OFF	101	121	117	201	301		
		ON	202	241	234	401	601		
100 mΩ	High	OFF	41	61	57	141	241		
		ON	82	121	114	281	481		
	Low	OFF	2.9	23	19	103	203		
		ON	5.7	45	39	205	405		
1000 mΩ	High	OFF	3.1	23	20	103	203		
		ON	6.1	46	39	206	406		
	Low	OFF	2.1	22	19	102	202		
		ON	4.1	44	37	204	404		
10 Ω	High	OFF	2.3	22	19	102	202		
		ON	4.5	44	37	204	404		
	Low	OFF	2.6	22	19	102	202		
		ON	5.1	45	38	205	405		
100 Ω	High	OFF	2.4	22	19	102	202		
		ON	4.7	44	38	204	404		
	Low	OFF	2.9	23	19	103	203		
		ON	5.7	45	39	205	405		
1000 Ω	-	OFF	2.9	23	19	103	203		
		ON	5.7	45	39	205	405		
10 kΩ		6.8	27	23	107	207			
100 kΩ		17	37	33	117	217			
1000 kΩ		131	151	147	231	331			
10 MΩ		521	517	521	517	601	701		
100 MΩ		1321	1317	1321	1317	1401	1501	ON	
		341	337	341	337	421	521	OFF	
1000 MΩ		361	357	361	357	441	541	OFF	

*1. RM3546 only

LP: ON (tolerance: ±10% ±0.2 ms, only with OVC is on) (RM3545A only)

■ RM3545A

Range	FAST		MEDIUM		SLOW1	SLOW2
	50 Hz	60 Hz	50 Hz	60 Hz		
LP1000 mΩ	71	64	111	98	431	1262
LP10 Ω	111	104	151	138	471	1342
LP100 Ω	111	104	151	138	471	1342
LP1000 Ω	113	106	153	140	473	1346

PR: On (tolerance: ±10% ±0.2 ms)

■ RM3546 (if AVERAGE is set to 2)

Range	Measurement current	A-OVC	FAST		MEDIUM		SLOW1	SLOW2
			50 Hz	60 Hz	50 Hz	60 Hz		
PR 1000 μΩ	High	OFF	-	-	-	-	-	-
		ON	83	162	149	482	882	
	Low*1	OFF	-	-	-	-	-	-
		ON	83	162	149	482	882	
PR10 mΩ	High	OFF	21	61	54	221	421	
		ON	83	162	149	482	882	
	Low*1	OFF	21	61	54	221	421	
		ON	83	162	149	482	882	
PR100 mΩ	---	OFF	21	61	54	221	421	
		ON	83	162	149	482	882	

■ RM3545A, RM3546 (if AVERAGE is set to off)

Range	Measurement current	OVC	FAST		MEDIUM		SLOW1	SLOW2
			50 Hz	60 Hz	50 Hz	60 Hz		
PR 1000 μΩ	High	OFF	-	-	-	-	-	-
		ON	42	81	74	241	441	
	Low*1	OFF	-	-	-	-	-	-
		ON	42	81	74	241	441	
PR10 mΩ	High	OFF	21	41	37	121	221	
		ON	42	81	74	241	441	
	Low*1	OFF	21	41	37	121	221	
		ON	42	81	74	241	441	
PR100 mΩ	---	OFF	21	41	37	121	221	
		ON	42	81	74	241	441	

*1. RM3546 only

Shortest conditions

Delay: 0 ms, TRIG logic setting: On, Self-calibration: MANUAL,
 Contact improvement: Off, Scaling: Off, Measured value display switching: none

If LP is set to On (RM3545A only)

OVC is fixed to On, if measurement speed is set to SLOW2, averaging is fixed to 2 times

Resistance D/A Output (response time: measurement time + max. 1 ms)	Shortest Shortest conditions	2.0 ms (tolerance: $\pm 10\% \pm 0.2$ ms) Trigger source INT, LP: Off, 1000 k Ω or lower range, Measurement speed: FAST, Delay: 0 ms, Self-calibration: MANUAL
Temperature measurement (thermistor sensor)	2 s (reference value)	
Temperature measurement (analog input)	50 ms (reference value), no moving average	

Accuracy specifications

Accuracy guarantee conditions	<p>Accuracy guarantee duration 1 year</p> <p>Accuracy guarantee temperature and humidity range 23°C $\pm 5^\circ\text{C}$ (73.4°F $\pm 41^\circ\text{F}$), 80% RH or less</p> <p>Accuracy specifications conditions Self-calibration function set to AUTO (Self-calibration function set to MANUAL, temperature fluctuations after self-calibration within $\pm 2^\circ\text{C}$ and interval within 30 min.)</p> <p>Temperature coefficient Add ($\pm 1/10$ of measurement accuracy per $^\circ\text{C}$) from 0°C to 18°C and from 28°C to 40°C.</p> <p>Warm-up time At least 60 minutes (When the instrument warms up for less than 60 minutes, measurement accuracy will be twice the value indicated in the accuracy table.)</p>				
Effect of radiated radio-frequency electromagnetic field	<p>At 10 V/m</p> <table border="0"> <tr> <td>RM3545A</td> <td>8% of full scale (10 MΩ range or less), 20% of full scale (100 MΩ range or greater)</td> </tr> <tr> <td>RM3546</td> <td>8% of full scale</td> </tr> </table>	RM3545A	8% of full scale (10 M Ω range or less), 20% of full scale (100 M Ω range or greater)	RM3546	8% of full scale
RM3545A	8% of full scale (10 M Ω range or less), 20% of full scale (100 M Ω range or greater)				
RM3546	8% of full scale				
Effect of conducted radio-frequency electromagnetic field	5% of full scale at 10 V				
Effects of external magnetic field	<p>At 30 A/m</p> <table border="0"> <tr> <td>RM3545A</td> <td>3% of full scale</td> </tr> <tr> <td>RM3546</td> <td>5% of full scale</td> </tr> </table>	RM3545A	3% of full scale	RM3546	5% of full scale
RM3545A	3% of full scale				
RM3546	5% of full scale				

Measurement accuracy

Resistance measurement

LP: Off and PR: Off

Range	Max. measurement range*1	Measurement current *3		OVC, A-OVC	Measurement accuracy ±(% of reading + % of full scale)*2				Additional accuracy without 0ADJ (% f.s.)*2	Max. open-terminal voltage	100 MΩ Range High-precision mode
		Switching			FAST	MED	SLOW1	SLOW2			
1000 μΩ	1200.000 μΩ	High	1 A	OFF	-				-	8.0 V*4 (20 V)*7	-
				ON	0.045+0.075	0.045+0.020	0.045+0.010				
		Low *6	500 mA	OFF	-						
				ON	0.090+0.150	0.090+0.040	0.090+0.020				
10 mΩ	12.000 00 mΩ	High	1 A	OFF	0.045+0.050	0.045+0.020	0.045+0.020	0.020			
				ON	0.045+0.015	0.045+0.002	0.045+0.001	-			
		Low *6	500 mA	OFF	0.090+0.100	0.090+0.040	0.090+0.040	0.020			
				ON	0.090+0.030	0.090+0.010	0.090+0.005	-			
100 mΩ	120.000 0 mΩ	High	1 A	OFF	0.045+0.010	0.045+0.010	0.045+0.010	0.002			
				ON	0.045+0.003	0.045+0.001	0.045+0.001	-			
		Low	100 mA	OFF	0.014+0.050	0.014+0.020	0.014+0.020	0.020			
				ON	0.014+0.015	0.014+0.002	0.014+0.001	-			
1000 mΩ	1200.000 mΩ	High	100 mA	OFF	0.012+0.010	0.012+0.008		0.002			
				ON	0.012+0.003	0.012+0.001		-			
		Low	10 mA	OFF	0.008+0.050	0.008+0.020		0.020			
				ON	0.008+0.015	0.008+0.002		-			
10 Ω	12.000 00 Ω	High	10 mA	OFF	0.008+0.010	0.008+0.008		0.002			
				ON	0.008+0.003	0.008+0.001		-			
		Low	1 mA	OFF	0.008+0.050	0.008+0.020		0.020			
				ON	0.008+0.015	0.008+0.002		-			
100 Ω	120.000 0 Ω	High	10 mA	OFF	0.007+0.005	0.007+0.002	0.007+0.001	-			
				ON	0.007+0.005	0.007+0.001	0.007+0.001	-			
		Low	1 mA	OFF	0.008+0.010	0.008+0.010		0.002			
				ON	0.008+0.003	0.008+0.001		-			
1000 Ω	1200.000 Ω	-	1 mA	OFF	0.007+0.005	0.006+0.002	0.006+0.001	-			
				ON	0.007+0.005	0.006+0.001	0.006+0.001	-			
10 kΩ	12.000 00 kΩ	-	1 mA	-	0.008+0.005	0.007+0.002	0.007+0.001	-			
100 kΩ	120.000 0 kΩ		100 μA		0.008+0.005	0.007+0.002	0.007+0.001	-			
1000 kΩ	1200.000 kΩ		10 μA		0.015+0.005	0.008+0.002	0.008+0.001	-			
10 MΩ	12.000 00 MΩ		1 μA		0.030+0.005	0.030+0.002	0.030+0.001	-			
100 MΩ	120.000 0 MΩ		100 nA		0.200+0.005	0.200+0.002	0.200+0.001	-			
	120.00 MΩ		1 μA or less		10.00 MΩ or less: 0.50 + 0.02 10.01 MΩ or more: 1.00 + 0.02			-			
1000 MΩ	1200.0 MΩ			100.0 MΩ or less: 1.00 + 0.02 100.1 MΩ or more: 10.00 + 0.02			-				
								ON			
								OFF			
								OFF			

PR: On

Range	Max. measurement range*1	Measurement current *3		OVC, A-OVC	Measurement accuracy ±(% of reading + % of full scale)*2				Additional accuracy without 0ADJ (% f.s.)*2	Max. open-terminal voltage	100 MΩ Range High-precision mode
		Switching			FAST	MED	SLOW1	SLOW2			
PR1000 μΩ	1200.000 μΩ	High	1 A	OFF	-				-	8.0 V*4 (20 V)*6	-
				ON	0.045+0.075	0.045+0.020	0.045+0.010				
		Low *6	500 mA	OFF	-						
				ON	0.090+0.150	0.090+0.040	0.090+0.020				
PR10 mΩ	12.000 00 mΩ	High	1 A	OFF	0.045+0.050	0.045+0.020	0.045+0.020	0.020			
				ON	0.045+0.015	0.045+0.002	0.045+0.001	-			
		Low *6	500 mA	OFF	0.090+0.100	0.090+0.040	0.090+0.040	0.020			
				ON	0.090+0.030	0.090+0.010	0.090+0.005	-			
PR100 mΩ	120.000 0 mΩ	-	1 A	OFF	0.045+0.010	0.045+0.010	0.045+0.010	0.002			
				ON	0.045+0.003	0.045+0.001	0.045+0.001	-			

LP: On (RM3545A only)

Range	Max. measurement range*1	Measurement accuracy ±(% of reading + % of full scale)*2				Measurement current *3	Max. open-terminal voltage
		FAST	MED	SLOW1	SLOW2		
LP1000 mΩ	1200.00 mΩ	0.200+0.100	0.200 +0.010	0.200+0.005	0.200+0.003	1 mA	20 mV*5
LP10 Ω	12.000 0 Ω	0.200+0.050	0.200+0.005	0.200+0.003	0.200+0.002	500 μA	
LP100 Ω	120.000 Ω	0.200+0.050	0.200+0.005	0.200+0.003	0.200+0.002	50 μA	
LP1000 Ω	1200.00 Ω	0.200+0.050	0.200+0.005	0.200+0.003	0.200+0.002	5 μA	

*1. -10% of full scale on the negative side

The maximum display range is 9,999,999 digits or 9 GΩ.

(If the maximum measurement range is exceeded, the over-range display will be shown even if the value is less than or equal to the maximum display range.)

*2.

• LP: Off:

0.001% of full scale = 10 digits.

However, if the 100 MΩ range high-precision setting is OFF in the 100 MΩ range or greater, 0.01% of full scale = 1 digit.

• LP: On (RM3545A only):

0.001% of full scale = 1 digit

• Measurement accuracy is the accuracy after zero adjustment. When not performing zero adjustment, the value indicated under [Additional accuracy without 0ADJ] is added.

• For the 1000 μΩ range, only when OVC or A-OVC is on; for LP, only when OVC is on.

• During temperature correction, the following value is added to the resistance measurement accuracy reading error:

$$\frac{-\alpha_{t_0}\Delta t}{1 + \alpha_{t_0} \times (t + \Delta t - t_0)} \times 100 (\%)$$

t_0 : Reference temperature (°C)

t : Current ambient temperature (°C)

Δt : Temperature measurement accuracy

α_{t_0} : Temperature coefficient (1/°C) at t_0

- *3. Measurement current accuracy is $\pm 5\%$
 - When using the 1000 Ω range or lower with an EXT trigger source or with continuous measurement off (non-free-run), the measurement current is only applied from the start of measurement (TRIG = ON) to the end of measurement (INDEX = ON). The measurement current is stopped at all other times.
If using the 10 k Ω or greater range, the measurement current will be applied continuously regardless of the trigger source setting.
 - When using the INT trigger source with continuous measurement on (free-run), the measurement current is stopped while the contact check indicates an error.
- *4. When using an external trigger source or when continuous measurement is off (non-free-run), the open voltage is limited to 20 mV or less from 7 ms after the completion of measurement (INDEX = ON) until the start of the next measurement (TRIG = ON).
- *5. When the contact check function is off (when the contact check function is on, 300 mV)
- *6. RM3546 only
- *7. A transient voltage condition lasting 1 ms or less occurs if the probe is moved out of contact with the measurement target while current is being applied.

Resistance D/A Output	Resistance measurement accuracy $\pm 0.2\%$ of full scale (temperature coefficient $\pm 0.02\%$ of full scale/ $^{\circ}\text{C}$)
------------------------------	---

Temperature measurement (thermistor sensor) $\pm 0.2^{\circ}\text{C}$
 Combined accuracy with Z2001 Temperature Sensor (t : measurement temperature [$^{\circ}\text{C}$])

Accuracy	Temperature range
$\pm(0.55 + 0.009 \times t - 10)^{\circ}\text{C}$	-10.0°C to 9.9°C
$\pm 0.50^{\circ}\text{C}$	10.0°C to 30.0°C
$\pm(0.55 + 0.012 \times t - 30)^{\circ}\text{C}$	30.1°C to 59.9°C
$\pm(0.92 + 0.021 \times t - 60)^{\circ}\text{C}$	60.0°C to 99.9°C

Temperature measurement (analog input) $\pm 1\%$ of reading ± 3 mV
 Temperature accuracy conversion method: $1\% \times (T_R - T_{0V}) + 0.3\% \times (T_{1V} - T_{0V})$
 T_{1V} : temperature at 1 V input
 T_{0V} : temperature at 0 V input
 T_R : ambient temperature
 Add temperature coefficient ($\pm 0.1\%$ of reading ± 0.3 mV/ $^{\circ}\text{C}$) to above accuracy for ambient temperature ranges 0°C to 18°C and 28°C to 40°C .
 Accuracy guarantee range : 0 V to 2 V
 Maximum allowable voltage : 2.5 V
 Detected resolution : 1 mV or less
 Display range : -99.9°C to 999.9°C

Calculation order	Zero adjustment \rightarrow Temperature correction \rightarrow Scaling
--------------------------	--

About instrument accuracy

Example accuracy calculations

(Digits in excess of display range are truncated.)

• Resistance measurement accuracy

Measurement conditions: 100 mΩ range, low current, OVC off, no zero adjustment, SLOW1, 30 mΩ measurement target

Resistance measurement accuracy: $\pm(0.014\%$ of reading + 0.020% of full scale),

Additional accuracy without 0ADJ: $\pm 0.020\%$ of full scale

$$\pm(0.014\% \times 30 \text{ m}\Omega + [0.02\% + 0.02\%] \times 100 \text{ m}\Omega) = \pm 0.0442 \text{ m}\Omega$$

• Temperature measurement accuracy

Measurement conditions: Thermistor temperature sensor, measurement temperature of 35°C

Temperature measurement accuracy: $\pm(0.55 + 0.012 \times |t - 30|)$

$$\pm(0.55 + 0.012 \times |35 - 30|) = \pm 0.610^\circ\text{C} \text{ (Truncate digits in excess of display range: } 0.6^\circ\text{C)}$$

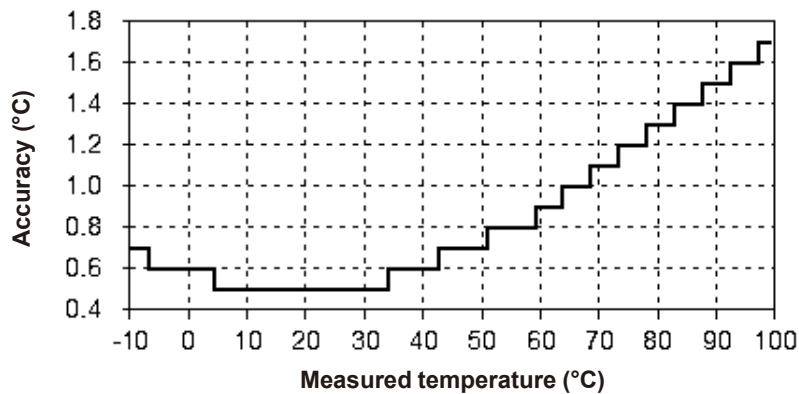

• Temperature correction additional accuracy

Measurement conditions: Temperature coefficient of 3930 ppm/°C, standard temperature of 20°C, measurement temperature of 35°C

Additional error:
$$\frac{-\alpha_{t_0} \Delta t}{1 + \alpha_{t_0} \times (t + \Delta t - t_0)} \times 100 (\%)$$

$$\frac{-0.393\% \times (\pm 0.6)}{1 + 0.393\% \times (35 \pm 0.6 - 20)} = +0.222\% \text{ of reading, } -0.223\% \text{ of reading}$$

Function Specifications

(1) Resistance range switching

Mode	AUTO, MANUAL (Automatically set to manual if the comparator or BIN function is turned on.)
Measurement range	LP Off: 1000 $\mu\Omega$, 10 m Ω , 100 m Ω , 1000 m Ω , 10 Ω , 100 Ω , 1000 Ω , 10 k Ω , 100 k Ω , 1000 k Ω , 10 M Ω , 100 M Ω , 1000 M Ω LP On: 1000 m Ω , 10 Ω , 100 Ω , 1000 Ω (RM3545A only) <ul style="list-style-type: none"> • With the 100 MΩ range high-precision setting on, the 1000 MΩ range cannot be used. • When using the MUX measurement terminal setting with the 2-wire measurement method, the 10 Ω and lower ranges cannot be used.
Default setting	Mode: AUTO, Measurement range: 1000 M Ω

(2) 100 M Ω range high-precision mode

Setting	ON/OFF
Default setting	OFF

(3) Number of measurement digits selection

Setting	7 digits, 6 digits, 5 digits (If the number of full scale digits is less than the setting, the number of full scale digits will be used.)
Default setting	7digits

(4) Active circuit protection (APC) function **RM3546**

Operation	The instrument automatically disconnects to protect its internal measurement circuitry if an over-voltage higher than the shutoff voltage is applied between the measurement terminals, or if the ambient temperature around the instrument exceeds the upper limit of its operating temperature range. In the event such a voltage is inadvertently applied, [Err:700] will be shown on the screen, and the "PROTECT" signal will be output to EXT. I/O. Measurement will resume when the voltage applied between the measurement terminals is less than or equal to the reconnect voltage.
Maximum allowable voltage	± 60 V DC, or 30 V AC rms and 42.4 V AC peak (between terminals) Resistance cannot be measured while the voltage is being applied. The maximum AC voltage application is 100 Hz (reference value).

(5) Pure resistance mode (PR)

Operation Measurement of resistance only to increase path resistance tolerances and shorten wait times (1000 μΩ to 100 mΩ range [1 A and 500 mA range only]).

Range	Measurement current	
	High	Low
PR1000 μΩ	1 A	500 mA*1
PR10 mΩ	1 A	
PR100 mΩ	1 A	-

*1. RM3546 only

Setting ON/OFF

Default setting OFF

(6) Low-power mode (LP) **RM3545A-1** **RM3545A-2**

No tolerance to voltage application in LP mode

Operation Low-power measurement is performed by limiting the measurement current and open voltage.
(1000 mΩ to 1000 Ω range)

Setting ON/OFF
(with OVC or A-OVC ON when LP is ON and the contact improvement function fixed to OFF)

Default setting OFF

(7) Switching Measurement Currents

Operation The measurement current is limited during measurement. (1000 μΩ to 100 Ω range)

Setting Measurement current: High/Low

Range	Measurement current	
	High	Low
1000 μΩ	1 A	500 mA*1
PR1000 μΩ		
10 mΩ	1 A	
PR10 mΩ		
100 mΩ	1 A	100 mA
PR100 mΩ		-
1000 mΩ	100 mA	10 mA
10 Ω	10 mA	1 mA
100 Ω	10 mA	1 mA

*1. RM3546 only

Default setting High

(8) Measurement speed setting

Setting	FAST, MED, SLOW1, SLOW2
Default setting	SLOW2

(9) Set the power frequency

Operation	Selects the line voltage frequency
Setting	AUTO (50 Hz or 60 Hz, auto-detect), 50 Hz, 60 Hz
Default setting	AUTO (auto-detect upon power on and resetting)

(10) Zero adjustment

Operation	Cancels the internal offset voltage and the surplus resistance.
Setting	ON/OFF (clear): For each range Scan zero adjustment ON/OFF: For each channel (RM3545A-2 and RM3546 only)
Adjustment range	Within ±50% of full scale for each range (warning message displayed when in excess of ±1% of full scale for each range) Zero adjustment cannot be used at 100 MΩ or above (it is forcibly turned off).
Default setting	Zero adjustment: OFF, Scan zero adjustment: ON

(11) Averaging

Operation	A moving average is used when using the INT trigger source with continuous measurement on (free-run). A mean average is used when using an EXT trigger source or with continuous measurement off (non-free-run). <table border="1" style="margin-left: auto; margin-right: auto;"> <thead> <tr> <th style="background-color: #d9e1f2;">Moving average</th> <th style="background-color: #d9e1f2;">Mean average</th> </tr> </thead> <tbody> <tr> <td style="text-align: center;"> $R_{avg(n)} = \frac{1}{A} \sum_{k=n}^{n+A-1} R_k$ </td> <td style="text-align: center;"> $R_{avg(n)} = \frac{1}{A} \sum_{k=(n-1)A+1}^{nA} R_k$ </td> </tr> </tbody> </table> <p><i>R_{avg}</i> : Average, <i>A</i> : Number of averaging iterations, <i>n</i>: Number of measurements, <i>R_k</i>: Measured value No. <i>k</i></p>	Moving average	Mean average	$R_{avg(n)} = \frac{1}{A} \sum_{k=n}^{n+A-1} R_k$	$R_{avg(n)} = \frac{1}{A} \sum_{k=(n-1)A+1}^{nA} R_k$
Moving average	Mean average				
$R_{avg(n)} = \frac{1}{A} \sum_{k=n}^{n+A-1} R_k$	$R_{avg(n)} = \frac{1}{A} \sum_{k=(n-1)A+1}^{nA} R_k$				
Setting	ON/OFF (When using the SLOW2 measurement speed with low-power resistance measurement on, the instrument will performing averaging with two iterations internally even if the averaging function is set to off.)				
Number of averaging iterations	2 to 100 times				
Default setting	RM3545A: OFF RM3546: 2 times				

(12) Delay setting

Operation	Adjusts the time for measurement to stabilize by inserting a waiting period after using the OVC, A-OVC, or the auto-range function to change the measurement current or after the TRIG signal.
Setting	Preset (internal fixed value)/ user-set (set value)
Preset	Starts integration after an internally fixed time (varies by range).
User setting	Start integration after the set time (applies to all ranges).
Delay setting range	0 ms to 9999 ms
Default setting	Preset/ 0 ms

Preset delay value (internal fixed) (unit: ms)

LP: Off and PR: Off

Range	Measurement current	Delay		100 MΩ Range High-precision mode
		OVC,A-OVC: OFF	OVC,A-OVC: ON	
1000 μΩ	High	-	38	-
	Low *1		6	
10 mΩ	High	38	13	
	Low *1	19	6	
100 mΩ	High	130	13	
	Low	20	1	
1000 mΩ	High	38	1	
	Low	4	2	
10 Ω	High	20	2	
	Low	5	2	
100 Ω	High	130	1	
	Low	20	2	
1000 Ω	-	130	1	
10 kΩ		180	-	
100 kΩ		95		
1000 kΩ		10		
10 MΩ		1		
100 MΩ		500		ON
		1		OFF
1000 MΩ		1		OFF

LP: On (RM3545A only)

Delay
1

PR: On

Delay
1

*1. RM3546 only

(13) Temperature measurement settings

Temperature sensor type	Thermistor sensor, analog input
Analog input formula	$t = \frac{T_2 - T_1}{V_2 - V_1} v + \frac{T_1 V_2 - T_2 V_1}{V_2 - V_1}$ <p> t: Displayed value (°C) v: Input voltage (V) V_1: Reference voltage 1 (V) Setting range: 0.00 V to 2.00 V T_1: Reference temperature 1 (°C) Setting range: -99.9°C to 999.9°C V_2: Reference voltage 2 (V) Setting range: 0.00 V to 2.00 V T_2: Reference temperature 2 (°C) Setting range: -99.9°C to 999.9°C </p>
Default setting	Sensor type: Thermistor sensor, V_1 : 0 V, T_1 : 0°C, V_2 : 1 V, T_2 : 100°C

(14) Temperature correction function (TC)

Operation	Temperature correction converts resistance values to resistance values at standard temperature and displays the result. (When ΔT is on, TC is automatically turned off.)
Formula	$R_{t_0} = \frac{R_t}{1 + \alpha_{t_0}(t - t_0)}$ <p> R_t: Measured resistance value (Ω) R_{t_0}: Corrected resistance value (Ω) t_0: Reference temperature (°C) Setting range: -10.0°C to 99.9°C t: Current ambient temperature (°C) α_{t_0}: Temperature coefficient (1/°C) at t_0 Setting range: -99,999 ppm/°C to 99,999 ppm/°C </p>
Setting	ON/OFF (When ΔT or A-TC* ¹ is on, TC is automatically turned off.)
Default setting	OFF, t_0 : 20°C, α_{t_0} : 3930 ppm/°C

*1. RM3546 only

(15) Advanced temperature correction function (A-TC) **RM3546**

Operation	<p>When the multiplexer unit is used, the temperature correction (TC) function is operated using the temperature value converted with the temperature conversion (ΔT) function as the current ambient temperature.</p> <p>Measurements are performed on the channel to which the temperature conversion function is applied in order to obtain the temperature values before and after the measurement on the channel for which the temperature correction is performed.</p> <p>From the obtained values, the temperature value is calculated for the channel for which the temperature correction is performed. The calculated value is used as the ambient temperature during the measurement.</p>
Setting	ON/OFF (When ΔT or TC is on, A-TC is automatically turned off.)
Default settings	OFF, t_0 : +20.0°C, α_{t_0} : +3930 ppm/°C, t_1 : +23.0°C, R_t : 10.00000 m Ω , TCR : 3930 ppm/°C, TERM: UNIT1, A: 1, B: 1, SPEED: SLOW2, RANGE: AUTO, DELAY: PRESET, AVERAGE: ON 002, A-OVC: ON, LOW POWER: OFF, PURE RES: ON, MEAS CURRENT: HIGH, CONTACT CHECK: ON, CONTACT IMPRV: OFF

(16) Offset voltage compensation

OVC: Offset voltage compensation

A-OVC: Advanced offset voltage compensation **RM3546**

Operation	OVC: Reverses measurement current polarity to eliminate offset voltage effects A-OVC (RM3546): Reverses measurement current polarity and uses the average value for each polarity to eliminate offset voltage effects
Applicable range	LP Off : 0 μΩ range to 1000 Ω range LP On : All ranges (RM3545A only)
Setting	ON/OFF (When low-power is on, OVC is fixed to on.)
Default setting	RM3545A : OFF RM3546 : ON, Averaging: 2 times (OVC operation if averaging is off.)

(17) Scaling

Operation	Measured values are corrected with the linear function $R_S = A \times R + B$ R_S : Value after scaling A : Gain coefficient Setting range: $0.200\ 0 \times 10^{-3}$ to $1.999\ 9 \times 10^3$ R : Measured value after zero adjustment and temperature correction B : Offset Setting range: 0 to $\pm 9 \times 10^9$ (maximum resolution: 1 nΩ)
Setting	ON/OFF
Display format	(When 9 G is exceeded, the over-range display is shown.)
Unit	Ω, none, user-selected 3 characters (Except SI prefix)
Default setting	OFF, A : 1.0000×1 , B : 0, Unit: Ω

(18) Self-calibration

Operation	Compensates for offset voltage and gain of measurement circuit.
Setting	AUTO, MANUAL
Compensation timing	AUTO : At power-on, after measured value, during TRIG standby (every 1 s) MANUAL : During EXT. I/O CAL signal input, when executing the calibration command
Self-calibration time	At power-on, when switching to auto, and during manual execution: 400 ms Auto: 5 ms (moving average)
Default setting	AUTO

(19) Contact improvement function

Operation	A voltage is applied between the SENSE A and SENSE B terminals after TRIG signal input, and a contact improvement current is allowed to flow for 0.2 ms.
Setting	OFF/ON (When LP is on, the contact improvement function is fixed to off.)
Default setting	OFF
Applied voltage	Max. 5 V
Contact improvement current	Max. 10 mA (flowing to the measurement target)

(20) Measurement fault detection

■ Over-range detection

Operation	Indicates under- or over-range values in the following conditions: <ul style="list-style-type: none"> • Measured value is outside of the measurement range • Measured value is outside of the A/D converter input range • Calculation result exceeded the number of display digits
------------------	---

■ Contact check

Operation	Checks the connections between SOURCE A and SENSE A, and between SOURCE B and SENSE B terminals.
Setting	ON/OFF (When using the MUX measurement terminal setting with the 2-wire measurement method, fixed to off. When using the 100 MΩ or greater range, the setting is fixed to ON.)
Threshold	50 Ω (reference value)
Default setting	ON (When LP is off), OFF (When LP is on)

■ Current fault detection

Operation	Detects faults in which the stipulated measurement current cannot be applied. No cancellation function.
Current fault mode setting	Current fault (ERR signal output), Over-range (HI signal output)

Display and output during current fault detection

		Current fault mode setting		
		Current fault	Over-range	
			Without error output	With error output
Contact check	Normal (No error)	Current fault display ERR signal output	Over-range display HI signal output	Over-range display HI signal output ERR signal output
	Fault (Error)	Contact error display ERR signal output		

Default setting	Current fault (ERR signal output)
------------------------	-----------------------------------

(21) Comparator

Operation	Compares setting and measured values	
Setting	ON/OFF (fixed range when the comparator function is on; the comparator function is automatically turned off when the ΔT and BIN functions are on)	
Judgment method	ABS mode, REF% mode	
Default setting	OFF, ABS mode	
Judgment	Judgment is based on the digit value (up to display digit) Hi: Measured value > Upper limit value IN: Upper limit value ≥ Measured value ≥ Lower limit value Lo: Lower limit value > measured value	
Total judgment	RM3545A-2	RM3546
Operation	When using the MUX measurement terminal setting with the scan function set to AUTO or STEP, a PASS/FAIL judgment is made for each channel, and a total judgment is determined.	
PASS/FAIL judgment (for each scan channel)	PASS: When the comparator judgment satisfies the PASS conditions FAIL: When the comparator judgment does not satisfy the PASS conditions	
PASS conditions	PASS: When all channels are PASS or when the PASS condition is OFF FAIL: When any channel is FAIL OFF, Hi, IN, Lo, Hi or Lo, ALL (for each scan channel)	
Default setting	IN	
ABS mode		
Upper/Lower limit ranges	0000.00 μΩ to 9000.00 MΩ*1	
Default setting	0000.00 μΩ	
REF% mode		
Display	Absolute value display and relative value display $(\text{Relative value}) = \left\{ \frac{(\text{Measured value})}{(\text{Reference value})} - 1 \right\} \times 100[\%]$	
Relative value display range	-999.999% to 999.999%	
Reference value range	0000.00 μΩ to 9000.00 MΩ*1 When using the MUX measurement terminal setting, the measurement results for scan channel 1 can be used as the reference value. (RM3545A-2 and RM3546 only)	
Upper/Lower limit ranges	0.000% to ±99.999%	
Default setting	Reference value: 0000.01 μΩ, Upper/Lower limit ranges: 0.000%	

*1. When set using the instrument's keys, the input range will reflect the range and scaling coefficient with a maximum resolution of 1 nΩ and a maximum value of 9 GΩ.

(22) BIN measurement function

Operation	Compares setting and measured values and displays the result.
Setting	ON/OFF (When the BIN function is on, the range and comparator functions are fixed to off. When ΔT is on while using the MUX measurement terminal setting, the BIN function is automatically turned off.)
Judgment method	ABS mode, REF% mode
Display	Absolute value (resistance value) display only
BIN number	0 to 9
Default setting	OFF
Judgment	Judgment is based on the digit value (up to display digits). Hi: Measured value > Upper limit value IN: Upper limit value \geq Measured value \geq Lower limit value Lo: Lower limit value > measured value
ABS mode	
Upper/Lower limit ranges	0000.0 0 $\mu\Omega$ to 9000.00 M Ω * ¹
Default setting	0000.0 0 $\mu\Omega$
REF% mode	
Reference value range	0000.0 1 $\mu\Omega$ to 9000.00 M Ω * ¹
Upper/Lower limit ranges	0.000% to $\pm 99.999\%$
Default setting	Reference value: 0000.0 1 $\mu\Omega$, Upper/Lower limit ranges: 0.000%

*1. When set using the instrument's keys, the input range will reflect the range and scaling coefficient with a maximum resolution of 1 n Ω and a maximum value of 9 G Ω .

(23) Judgment beeper setting

Operation	Sounds a beeper based on the comparator judgment result or total judgment. (Set Hi, IN, and Lo separately, and when using the MUX measurement terminals, set PASS and FAIL separately.)
Settings	Tones: type 1, type 2, type 3, OFF
Number of beeps	1 to 5 times, continuous
Default setting	OFF, 2 times

(24) Auto hold

Operation	Holds measured values automatically (only when using the measurement terminals on the front of the instrument with the INT trigger source and continuous measurement on [free-run]). The hold is canceled when the measurement leads are removed from the target and the next measurement performed, or when the  key is pressed.
Setting	ON/OFF
Default setting	OFF

(25) Temperature conversion (ΔT)

Operation	Utilizing the temperature-dependent nature of resistance, the temperature conversion function converts resistance measurements for display as temperatures.
Formula	$\Delta t = \frac{R_2}{R_1}(k + t_1) - (k + t_2)$ <p> Δt: Temperature increase (°C) t₁: Winding temp. (°C, cool state) when measuring initial resistance R₁ Setting range: -10.0°C to 99.9°C t₂: Ambient temp. (°C) at final measurement R₁: Winding resistance (Ω) at temp. t₁ (cool state) Setting range: 0.001 μΩ to 9000.000 MΩ*¹ R₂: Winding resistance (Ω) at final measurement k: Reciprocal (°C) of temp. coefficient of conductor material at 0°C Setting range: -999.9 to 999.9 </p> <p>*1. When set using the instrument's keys, the input range will reflect the range and scaling coefficient with a maximum resolution of 1 nΩ and a maximum value of 9 GΩ.</p>
ΔT display range	-9999.9°C to 9999.9°C
Setting	ON/OFF (When the ΔT function is on, the comparator functions are fixed to off. ΔT is automatically turned off when TC or A-TC* ¹ , the statistical calculation function, and the BIN function are on.)
Default setting	OFF, t ₁ : 23.0°C, R ₁ : 1.000 0 Ω, k: 235.0

*1. RM3546 only

(26) Statistical calculation

Operation	Statistical calculations are performed on measured values.
Setting	ON/OFF (The statistical calculation function is automatically turned off when ΔT is on while using the MUX measurement terminal setting.)
Maximum number of data points	30,000
Calculations	Total data count, Number of valid data samples, Mean, Minimum value (index no.), Maximum value (index no.), Standard deviation of sample, Population standard deviation <ul style="list-style-type: none"> • When the comparator function is ON Count for each comparator judgment, Process capability indices (dispersion, bias) • When the BIN function is ON Count for each BIN number, OUT (Hi or Lo) count for all BIN numbers, invalid BIN count
Clearing calculations	Clear all data, clear 1 data point (to revert to data immediately before measurement)
Default setting	OFF

(27) Panel Save, Panel Load

Operation	Saves and loads measurement conditions using user-specified panel numbers.
Number of panels	When using the measurement terminals on the front of the instrument: 30; when using the MUX measurement terminal setting: 8
Panel names	10 characters (letters or numbers)
Saved data	Save time and date, resistance range, 100 MΩ high-precision mode, low-power mode (LP), pure resistance mode (PR), switching measurement currents, measurement speed, zero adjustment, average, delay, temperature correction (TC), advanced temperature correction (A-TC)* ¹ , offset voltage compensation (OVC), advanced offset voltage compensation (A-OVC)* ¹ , scaling, self-calibration setting, contact improvement, contact check, comparator, BIN setting, judgment beeper, Auto Hold, temperature conversion (ΔT), statistical calculations setting, multiplexer setting (for all channels) *1. RM3546 only
Loading of zero adjustment values	ON/OFF
Default setting	ON

(28) Clock

Operation	Auto calendar, auto leap year, 24-hour clock
Accuracy	Approx. ±4 minutes/ month
Default setting	2023-10-01 (yyyy-mm-dd), 00:00

(29) Reset the instrument

■ **Reset the instrument**

Operation	Resets settings (except panel data) to factory defaults
------------------	---

■ **System reset**

Operation	Reverts all settings, including panel data, to their default values.
------------------	--

■ **Multiplexer channel reset** **RM3545A-2** **RM3546**

Operation	Returns the multiplexer channel settings to the factory defaults.
------------------	---

(30) Self-test

■ **Self-test at startup**

Operation	ROM/RAM check, measurement circuit protective fuse check
------------------	--

■ **Z3003 unit test** **RM3545A-2** **RM3546**

Operation	Each pin's round-trip route resistance value is measured with all the A and B terminals shorted while in the 2-terminal resistance measurement state, and the number of contacts is displayed.
Judgment criterion	Short test: FAIL when the resistance measurement is 1 Ω or more in the shorted state Open test: FAIL when no measurement fault is detected in the open state

(31) Absolute value display

Operation	Displays negative measured values as absolute values. The Measurement screen will indicate [ABS].
Setting	ON/OFF
Default setting	OFF

Interface Specifications

(1) Display

LCD type	Monochrome graphical LCD 240 × 110
Backlight	White LED Brightness adjustment range: 0% to 100% (5% increments), Default setting: 80% When EXT is being used as the trigger source, the backlight dims after a period of no operation. Brightness recovers upon front panel key operation.
Contrast	Adjustment range: 0% to 100% (5% increments), Default setting: 50%
Measured value display switching	The following display modes are provided in addition to the normal measured value display: No display/ temperature/ pre-calculation resistance value (TC, scaling, REF%, ΔT)

(2) Key

COMP, PANEL, ▼, ▲, ►, ◀, MENU, F1, F2, F3, F4, ESC, ENTER, AUTO, ▼, ▲ (range), ⏻ (standby), SPEED

■ Key lock

Operation	Disables operation of unneeded keys. Can be canceled using a communication command.
Setting	OFF/menu lock/full lock Menu lock : Disables all keys other than the keys listed below and the key used to cancel key lock [UNLOCK] . COMP, PANEL, AUTO, ▼, ▲ (range), SPEED, 0ADJ, PRINT, STAT, STOP All-key lock : Disables all except the key used to cancel key lock [UNLOCK] . All front panel keys are disabled when the KEY_LOCK signal is received.
Default setting	OFF

■ Key operation sound setting

Setting	ON/OFF
Default setting	ON

Communications Interface Specifications

Interface types	LAN, RS-232C, PRINTER, USB
Default setting	RS-232C

(1) LAN

Applicable standard	IEEE802.3
Transfer method	10BASE-T,100BASE-TX auto-detect, Half/Full Duplex, Auto MDI-X
Protocol	TCP/IP
Connector	RJ-45
Communication contents	Configuring settings and acquiring measured values with communications commands
IP address	xxx.xxx.xxx.xxx (xxx: 0 to 255)
Subnet mask	xxx.xxx.xxx.xxx (xxx: 0 to 255)
Default gateway	xxx.xxx.xxx.xxx (xxx: 0 to 255)
Communications command port	11 to 65535 (except 80)
Message terminator (delimiter)	Receiving: CR+LF, CR, LF Transmitting: CR+LF
Default	IP address: 0.0.0.0, Subnet mask: 255.255.255.0, Default gateway: OFF (0.0.0.0), Communications command port: 23

(2) RS-232C

Communication contents	Remote control, measured value output (export)
Transfer method	Communications: Full duplex Synchronization: Start-stop synchronization
Transmission speed	9600 bps (default setting), 19200 bps, 38400 bps, 115200 bps
Data length	8 bits
Stop bit	1
Parity bit	None
Handshaking	No X-flow, no hardware flow
Protocol	Non-procedure
Message terminator (delimiter)	Receiving: CR+LF, CR, LF Transmitting: CR+LF
Connector	Male 9-pin D-sub, with #4-40 Screw lock

(3) USB

Communication contents	Remote control, measured value output (export)
Connector	Series B receptacle
Electrical specifications	USB2.0 (Full Speed)
Class (mode)	CDC Class (COM mode), HID Class (USB keyboard mode)
Message terminator (delimiter)	Receiving: CR+LF, CR, LF Transmitting: CR+LF
Default setting	COM mode

(4) Printer

Operation	Prints data when the PRINT signal is input or when the print key is pressed.
Compatible printers	Interface: RS-232C, no. of characters per line: 48 (single-byte) or more Communication speed: 9600 bps, 19200 bps, 38400 bps, 115200 bps Data length: 8 bits, Parity: none, Stop bit: 1 bit, Flow control: none, Message terminator (delimiter) CR+LF Must be able to print control codes or plain text directly.
Printing contents	Resistance measured values, temperature measured values, judgment results, measurement conditions, statistical results
Interval	ON/OFF
Interval time	0 s to 3600 s
Statistical calculations clear	ON/OFF
Number of columns printed per row	1 column, 3 columns
Default setting	Interval: OFF, Interval time: 1 s, Statistical calculations clear: OFF, Number of columns printed per row: 1 column

(5) Communications functionality

Remote function	During communications via USB, RS-232C, or LAN, all front panel key operations are disabled. Remote operation is canceled as follows: <ul style="list-style-type: none"> • LOCAL key, Reset, At power-on • Via USB, RS-232C, or LAN :SYSTEM:LOCa1 command
Command monitor function	Displays the send/receive status of commands and queries. Setting: ON/OFF
Data output function	During INT trigger source operation, measured values are output at TRIG signal or ENTER key input. During EXT trigger source operation, measured values are automatically output each time measurement completes. (USB keyboard mode is available during INT trigger source use only.) Setting: ON/OFF
Memory function	Measured values stored in the instrument's memory are sent at once. (The memory function is automatically turned off when using the MUX measurement terminal setting.) Number of memory units: 50 (volatile memory, no backup) Setting: ON/OFF
Default setting	Command monitor function: OFF, Data output: OFF, Memory function: OFF

(6) EXT. I/O

Connector	Female 37-pin D-sub, with #4-40 Screw lock
------------------	--

■ Input

Electrical specifications	Input type	Photocoupler-isolated no-voltage contact input (current sink/source output compatible)
	Input asserted (ON)	Residual voltage: 1 V or less (Input ON current: 4 mA [reference value])
	Input asserted (OFF)	Open (shutoff current: 100 μ A or less)
	Response time	ON edge: Max. 0.1 ms, OFF edge: Max. 1.0 ms
Input signals	TRIG (IN0), CAL, KEY_LOCK, 0ADJ, PRINT (IN1), MUX, SCN_STOP, LOAD0 to LOAD5, BCD_LOW (Valid only with BCD mode output)	

■ Output

Electrical specifications	Output type	Photocoupler-isolated open-drain output (non-polar)
	Maximum load voltage	30 V DC
	Residual voltage	1 V or less (load current: 50 mA) 0.5 V or less (load current: 10 mA)
	Maximum output current	50 mA/channel
Output signals	Output mode switching: JUDGE mode, BCD mode JUDGE mode EOM, ERR, INDEX, HI, IN, LO, T_ERR, T_PASS, T_FAIL, BIN0 to BIN9, OB, OUT0 to OUT2, PROTECT BCD mode EOM, ERR, IN, HILO When BCD_LOW is ON: BCD1 to BCD3 \times 4 digits, RNG_OUT0 to RNG_OUT3 When BCD_LOW is OFF: BCD4 to BCD7 \times 4 digits Default setting JUDGE mode	

■ Trigger source setting function

Setting	INT (Internal), EXT (External) (Only the EXT setting is available when the measurement pin setting is MUX (multiplexer) and the scan function is set to auto or step mode.)
Default setting	INT (Internal)

■ TRIG/PRINT filter function

Setting	ON/OFF
Operation	During the response time, signal processing is performed only while the input signal is held in the on state.
Response time	50 ms to 500 ms
Default setting	OFF, 50 ms

■ TRIG logic setting

Setting	OFF edge/ ON edge
Default setting	ON edge

■ EOM output timing setting

Setting	HOLD/PULSE
Operation	When using an EXT trigger source with the HOLD setting, the on state is held until the next TRIG signal or 0ADJ signal is input. When using an EXT trigger source with the PULSE setting, the off state is held after the pulse width setting has elapsed. When using the INT trigger source, EOM output is fixed to pulse output with a width of 5 ms (when using auto self-calibration) or no EOM output is generated (when using manual self-calibration), regardless of the EOM output timing setting.
Pulse width	1 ms to 100 ms
Default setting	HOLD, 5 ms

■ EXT. I/O test function

Operation	Displays the EXT. I/O input signal state and generates output signals as desired.
------------------	---

■ Service power supply output

Output voltage	For sink output: 5.0 V \pm 10% For source output: -5.0 V \pm 10%, 100 mA max.
Isolation	Floating from protective ground potential and measurement circuit
Insulation rating	Line-to-earth voltage 50 V DC, or 30 V AC rms and 42.4 V AC peak or less

(7) Multiplexer **RM3545A-2** **RM3546**

Number of installed units	Max. 2				
Measurement terminal settings	<p>Front terminals/ MUX (multiplexer) (When using the MUX setting, the memory function is fixed to off. If the statistical calculation function or BIN function is set to on, the measurement terminal setting will be automatically set to the front terminals.) When using the MUX setting, the measurement leads cannot be connected to the front measurement terminals.</p>				
Supported unit	Z3003				
Z3003 control specifications					
Measurement method	<p>2-wire/ 4-wire (When using 2-wire, the minimum measurement range is the 100 Ω range, and the contact check is fixed to the OFF setting.)</p>				
Scan function	<p>OFF/ Auto (measure all channels at each TRIG signal)/ Step (measure 1 channel at each TRIG signal) When the scan function is set to auto or step, the trigger source is fixed to EXT. FAIL stop ON/ OFF</p>				
Channel settings	<p>The A and B terminals of each channel can be individually assigned to user-specified terminals. The measurement current will flow from the B terminal to the A terminal. Channel: Enable/ disable A terminal: 10 terminals (4-wire) or 21 terminals (2-wire) per unit as specified by the user B terminal: 10 terminals (4-wire) or 21 terminals (2-wire) per unit as specified by the user Measuring instrument selection: Instrument measurement / external device measurement</p> <p>The following measurement conditions can be set by channel. Resistance range, 100 MΩ range high-precision mode, low-power mode (LP), switching measurement currents, measurement speed, zero adjustment, average, delay, temperature correction (TC, A-TC), offset voltage compensation (OVC, A-OVC), pure resistance mode (PR), scaling, contact improvement, contact check, comparator, temperature conversion (ΔT)</p>				
Relay hot switching prevention function	<p>The current between current-generating terminals (between SOURCE terminals) is monitored and relay switching is controlled so that it does not occur until the current falls below a certain level.</p>				
Contact cycle count recording function	<table> <tr> <td>Contacts to be recorded</td> <td>All</td> </tr> <tr> <td>Maximum recordable number</td> <td>999,999,999 times</td> </tr> </table>	Contacts to be recorded	All	Maximum recordable number	999,999,999 times
Contacts to be recorded	All				
Maximum recordable number	999,999,999 times				
Number of channels that can be set	42				
Switching time	30 ms (reference value, not including measurement time and range switching time)				

Default setting

Measurement method: 4-wire, Scan function: Auto, FAIL stop: OFF, channel default settings as follows (default measurement conditions)

4-wire

Channel number	Channel	Unit	A terminal	B terminal
1	Enabled	1	TERM A1	TERM B1
2 to 10	Disabled	1	TERM A2 to TERM A10	TERM B2 to TERM B10
11 to 20	Disabled	2	TERM A1 to TERM A10	TERM B1 to TERM B10
21 to 42	Disabled	1	TERM A1	TERM B1

2-wire

Channel number	Channel	Unit	A terminal	B terminal
1	Enabled	1	TERM A1	TERM B1
2 to 21	Disabled	1	TERM A2 to TERM A21	TERM B2 to TERM B21
22 to 42	Disabled	2	TERM A1 to TERM A21	TERM B1 to TERM B21

(8) D/A output

Output	Resistance measured value (display value after zero adjustment and temperature correction but before scaling and ΔT calculation)
Output voltage	0 V DC (corresponds to 0 digits) to 1.5 V DC *1 If a measured value fault occurs, 1.5 V; if the measured value is negative, 0 V *1. 1,200,000 digits display corresponds to 1.2 V (1,200,000 digits) 120,000 digits display corresponds to 1.2 V (120,000 digits) 12,000 digits display corresponds to 1.2 V (12,000 digits) For a display in excess of 1.5 V, fixed at 1.5 V.
Maximum output voltage	5 V
Output impedance	1 k Ω
Number of bits	12 bit

(9) L2105 LED Comparator Attachment output

Output	Comparator judgment output (two outputs: Hi and Lo/IN)
Output terminal	3-pole earphone terminal ($\varnothing 2.5$ mm)
Output voltage	5 V ± 0.2 V DC, 20 mA

Z3003 Multiplexer Unit

General specifications

(1) Measurement targets (wiring order is user-selected)

4-wire	10 locations (when using two Z3003 units, 20 locations)
2-wire	21 locations (when using two Z3003 units, 42 locations)

(2) Multiplexer I/O (direction of current application is fixed)

Measurement terminal (4-wire)	TERM A1 terminal to TERM A10 terminal, TERM B1 terminal to TERM B10 terminal (TERM terminal: combinations of the following terminals SOURCE terminal: Current source terminal, SENSE terminal: Voltage detection terminal) EX SOURCE A, EX SOURCE B : External device connection terminal (current) EX SENSE A, EX SENSE B : External device connection terminal (voltage)
Measurement terminal (2-wire)	TERM A1 terminal to TERM A21 terminal, TERM B1 terminal to TERM B21 terminal EX A, EX B: External device connection terminal
Shielding terminal	GUARD terminal: Guard terminal EARTH terminal: Function ground terminal EX GUARD: External device guard terminal
Connector	D-SUB 50 pin receptacle

(3) Pinouts

4-wire

No.	Pin name	No.	No.	Pin name	No.	Pin name
1	-	-	18	TERM B5	34	TERM B9
2	TERM B1	SOURCE	19		SOURCE	35
3		SENSE	20	TERM A5	36	TERM A9
4	TERM A1	SOURCE	21		SOURCE	37
5		SENSE	22	TERM B6	38	TERM B10
6	TERM B2	SOURCE	23		SOURCE	39
7		SENSE	24	TERM A6	40	TERM A10
8	TERM A2	SOURCE	25		SOURCE	41
9		SENSE	26	TERM B7	42	-
10	TERM B3	SOURCE	27		SENSE	43
11		SENSE	28	TERM A7	44	GUARD
12	TERM A3	SOURCE	29		SOURCE	45
13		SENSE	30	TERM B8	46	EX SENSE B (EX Pot Hi)
14	TERM B4	SOURCE	31		SOURCE	47
15		SENSE	32	TERM A8	48	EX SOURCE A (EX Cur Lo)
16	TERM A4	SOURCE	33		SOURCE	49
17		SENSE			50	EARTH

2-wire

No.	Pin name	No.	Pin name	No.	Pin name
1	TERM A1	18	TERM B9	34	TERM B17
2	TERM B1	19	TERM B10	35	TERM B18
3	TERM B2	20	TERM A10	36	TERM A18
4	TERM A2	21	TERM A11	37	TERM A19
5	TERM A3	22	TERM B11	38	TERM B19
6	TERM B3	23	TERM B12	39	TERM B20
7	TERM B4	24	TERM A12	40	TERM A20
8	TERM A4	25	TERM A13	41	TERM A21
9	TERM A5	26	TERM B13	42	TERM B21
10	TERM B5	27	TERM B14	43	GUARD
11	TERM B6	28	TERM A14	44	GUARD
12	TERM A6	29	TERM A15	45	EX B (EX Hi)
13	TERM A7	30	TERM B15	46	EX B (EX Hi)
14	TERM B7	31	TERM B16	47	EX A (EX Lo)
15	TERM B8	32	TERM A16	48	EX A (EX Lo)
16	TERM A8	33	TERM A17	49	EX GUARD
17	TERM A9			50	EARTH

(4) Measurable range

Measurement current	Instrument with Z3003: 1 A DC or less Externally connected device: 1 A DC or less, 100 mA AC or less
Measurement frequency	Externally connected device: DC, 10 Hz to 1 kHz

(5) Contact specifications

Contact type	Mechanical relay
Maximum allowable voltage	± 60 V DC, or 30 V AC rms and 42.4 V AC peak
Maximum allowable power	30 W (DC) (Resistance load)
Contact service life	4-wire: 50 million cycles. 2-wire: 5 million cycles (reference value)

Measurement specifications

(1) Conditions of guaranteed accuracy

Warm-up time	Same as instrument with the Z3003.
Accuracy guarantee temperature and humidity range	23°C ±5°C (73.4°F ±41°F), 80%RH or less
Accuracy guarantee duration	1 year
Accuracy specifications conditions	When using a 2-wire setup, accuracy is guaranteed only after zero adjustment.
Temperature coefficient	From 0°C to 18°C and 28°C to 40°C, add a temperature coefficient of ±(1/10 of additional accuracy)/°C.

(2) Additional accuracy (Add the following error components to the instrument's measurement accuracy.)

Effects of leak current	<p>Add a reading error as follows depending on the measurement current (when using guarding) (With humidity of less than 70% RH. If the humidity is greater than or equal to 70% RH, add the following reading error × 5.):</p> $\frac{1 \times 10^{-9} \text{ (A)}}{I_{\text{MEAS}} \text{ (A)}} \times 100 \text{ (\% of reading)}$ <p>I_{MEAS}: Measurement current</p>
Effect of measurement speed	<p>Add the full scale error component as follows when the integration time is not a whole-number multiple of the power supply cycle:</p> $A_{\text{fs}} \times 0.5 \text{ (\% of full scale)}$ <p>A_{fs}: full scale error component for instrument with the Z3003</p>
Effect of offset voltage	<p>Add the following resistance to the error when OVC is OFF</p> $\frac{10 \times 10^{-6} \text{ (V)}}{I_{\text{MEAS}} \text{ (A)}} \text{ (\Omega)}$ <p>I_{MEAS}: Measurement current</p>
Effect of offset resistance fluctuations	<p>When using a 2-wire setup, add the following resistance to the error component.</p> <p>0.1 (Ω)</p>

(3) Internal offset resistance

Internal measurement circuit resistance value	0.5 Ω (default)
--	-----------------

About instrument accuracy

Example accuracy calculations

(Digits in excess of display range are truncated.)

• Resistance measurement accuracy when using the Z3003

RM3545A or RM3546 measurement conditions:

100 kΩ range, measurement current of 100 μA,

OVC or A-OVC off, 0ADJ on, FAST, measurement target of 30 kΩ

Resistance measurement accuracy $\pm(0.008\%$ of reading $+0.005\%$ of full scale)

The accuracy error component is calculated first, and then the total error component is calculated.

(1) Calculating the accuracy error component

- Effects of leak current
The effects of leak current are determined based on the ratio of leak current to measurement current. The result is added to the reading error.

$$\text{Additional error: } A = (1 \times 10^{-9}) / (100 \times 10^{-6}) \times 100 = 0.001\% \text{ of reading}$$

- Effect of measurement speed (During FAST measurement, the integration time is not a whole-number multiple of the power supply cycle.)
If the integration time is not a whole-number multiple of the power supply cycle, the effects of commercial power noise will be more pronounced.

$$\text{Additional error: } B = 0.005 \times 0.5 = 0.0025 \% \text{ of full scale}$$

- Effect of offset voltage
The relay and connector thermoelectric force is observed as a measured value offset. When using with OVC or A-OVC on, there is no need to add this.

$$\text{Additional error: } C = (10 \times 10^{-6}) / (100 \times 10^{-6}) = 0.1 \Omega$$

- Effect of offset resistance fluctuations
During 2-wire operation, results are affected by fluctuations in the internal offset resistance.

$$\text{Additional error: } D = +0.1 \Omega$$

(2) Calculating the total error component

$$\text{4-wire: } E = \pm\{(0.008 + A) \% \times 30 \text{ k}\Omega + (0.005 + B) \% \times 100 \text{ k}\Omega + C\} = \pm 10.3$$

$$\text{2-wire: } E + D = +10.4 \Omega, -10.3 \Omega$$

Function

(1) Contact cycle count recording function

A contact cycle count of up to 999,999,999 can be recorded using control from the instrument with the Z3003.

(2) Unit test

By shorting all the pins numbered 1 to 42, each measurement pin's round-trip route resistance value in the 2-terminal resistance measurement state can be checked using control from the instrument with the Z3003.

(3) Relay hot switching prevention monitor function

The current flowing between the current generation terminals (SOURCE terminals) can be monitored using control from the instrument with the Z3003.

Environment and safety specifications

Operating environment	Indoor use, pollution degree 2, altitude up to 2000 m (6562 ft.)
Storage temperature and humidity range	-10°C to 50°C (14°F to 122°F), 80%RH or less (non-condensing)
Operating temperature and humidity range	0°C to 40°C (32°F to 104°F), 80%RH or less (non-condensing)
Standards	
Safety	EN 61010
EMC	EN 61326 Class A Effect of radiated radio-frequency electromagnetic field: 5% of full scale at 10 V/m (added to the effect on the instrument with the Z3003) Effect of conducted radio-frequency electromagnetic field: 5% of full scale at 3 V (added to the effect on the instrument with the Z3003)
Dimensions	Approx. 92W × 24.5H × 182D mm (3.62W × 0.96H × 7.17D in.) (excluding protrusions)
Weight	Approx. 180 g (6.3 oz.)
Product warranty duration	3 years Relay: Not covered by the warranty

Included accessories

Instruction Manual	1
D-SUB 50-pin connector	1 (pin header, solder cup)

Measurement Leads (Options)

L2101 Clip Type Lead

These leads have clip tips. Four-terminal measurements are provided just by clipping on to the measurement target.

Overall length: Approx. 1500 mm

Bifurcation-to-lead length: Approx. 250 mm

Clippable diameter: $\varnothing 0.3$ mm to 5.0 mm

Maximum rated voltage to earth:

30 V AC rms, 42.4 V peak, 60 V DC

Maximum rated voltage:

30 V AC rms, 42.4 V peak, 60 V DC

Maximum rated current: 3 A AC/DC

L2102 Pin Type Lead

Even on flat contact points that cannot be clipped to, or on measurement targets with small contacts such as relay terminals or connectors, four-terminal measurements are available by just pressing.

Overall length: Approx. 1500 mm

Bifurcation-to-lead length: Approx. 250 mm

Pin tip: $\varnothing 1.8$ mm

Initial contact pressure: Approx. 70 g

Total compression pressure: Approx. 100 g (Stroke: Approx. 2 mm)

Maximum rated voltage to earth:

30 V AC rms, 42.4 V peak, 60 V DC

Maximum rated voltage:

30 V AC rms, 42.4 V peak, 60 V DC

Maximum rated current: 3 A AC/DC

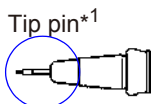
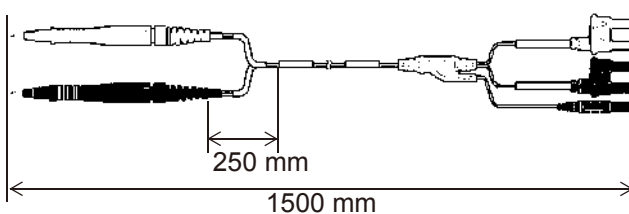
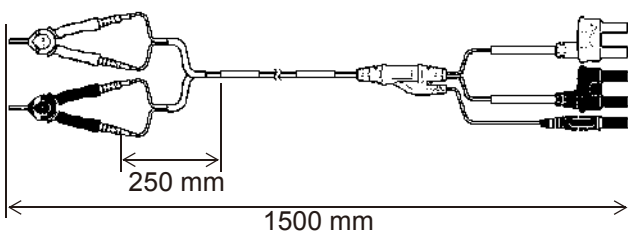

*1. Tip pins can be exchanged.
9770-90 Tip pin

L2103 Pin Type Lead

The tips have a four-terminal design developed for floating-foot testing of ICs mounted on boards.

Resistance can be correctly measured even with small measurement targets.

Overall length: Approx. 1500 mm

Bifurcation-to-lead length: Approx. 250 mm

Between pin bases: 0.2 mm

Initial contact pressure: Approx. 60 g

Total compression pressure: Approx. 140 g (Stroke: Approx. 1.3 mm)

Maximum rated voltage to earth:

30 V AC rms, 42.4 V peak, 60 V DC

Maximum rated voltage:

30 V AC rms, 42.4 V peak, 60 V DC

Maximum rated current: 2 A AC/DC

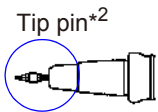
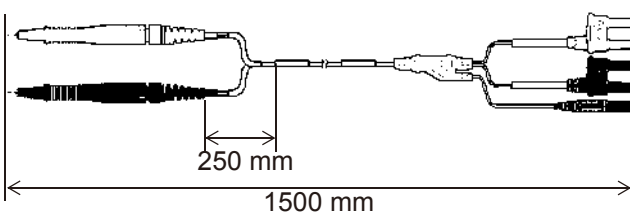

*2. Tip pins can be exchanged.
9771-90 Tip pin

L2100 Pin Type Lead

These 4-terminal pin-type leads are ideal for measuring resistance at locations such as welds. The tips of the parallel two pin type enable stable contact for measurement.

Overall length: Approx. 1400 mm

Bifurcation-to-lead length: Approx. 300 mm

Between pin bases: 2.5 mm

Maximum rated voltage to earth: 1000 V DC

Maximum rated voltage: 1000 V DC

Maximum rated current: 2 A DC

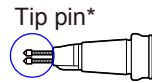
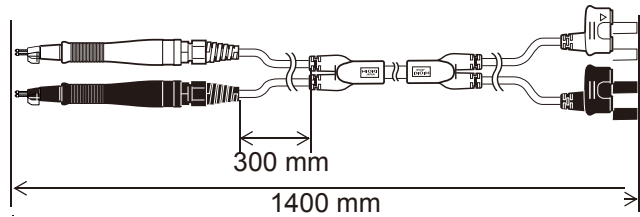

* Tip pins can be exchanged.
9772-90 Tip pin

RM9010-01 Four-Point Array Probe

RM3545A-1 RM3545A-2

Using a dedicated PC application for the RM3545A, resistivity and conductivity can be measured with a four-point probe array.

Overall length: Approx. 1500 mm

Between pin bases: 5.0 mm

Maximum rated voltage to earth:

30 V AC rms, 42.4 V peak, 60 V DC

Maximum rated voltage:

30 V AC rms, 42.4 V peak, 60 V DC

Maximum rated current: 3 A AC/DC

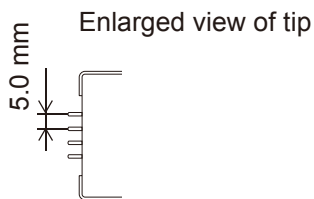
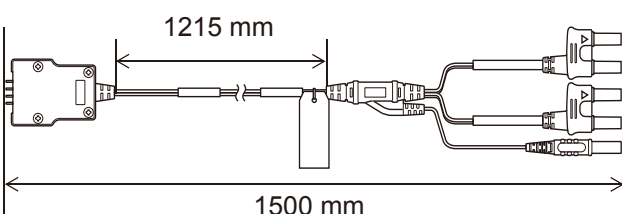

RM9010-02 Four-Point Array Probe

RM3545A-1 RM3545A-2

Using a dedicated PC application for the RM3545A, resistivity and conductivity can be measured with a four-point probe array.

Overall length: Approx. 1500 mm

Between pin bases: 1.5 mm

Maximum rated voltage to earth:

30 V AC rms, 42.4 V peak, 60 V DC

Maximum rated voltage:

30 V AC rms, 42.4 V peak, 60 V DC

Maximum rated current: 1.5 A AC/DC

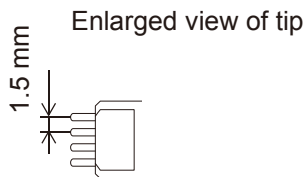
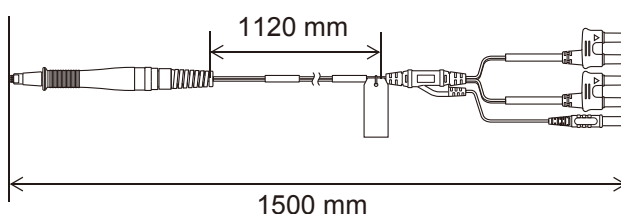

Outline Drawing

The figures show the RM3546, but three models have the same dimensions.

Unit: mm

